

Off-grid Inverter User Manual

SNA-EU 12K

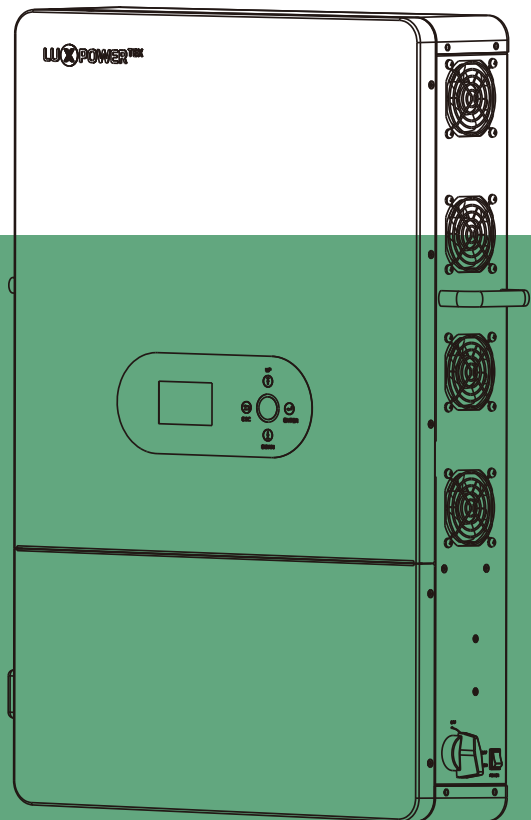

Copyright© 2024 Lux Power Technology Co., Ltd. All Rights Reserved. This manual, protected by the copyright and intellectual property rights of Lux Power Technology, may not be modified, copied, or reproduced without prior written permission. Brands and trademarks mentioned belong to their respective owners. Read carefully for product reliability and warranty eligibility. For warranty details, refer to Lux Power Technology Limited Warranty. Intended for professional service providers; no statements constitute an express or implied warranty.

Descriptions may contain predictive statements; differences may occur. Provided for reference, subject to change without notice by Lux Power Technology.



Website



YouTube



Facebook

 www.luxpowertek.com



Scan to download

Table Of Contents

Information on this Manual	1
Validity	1
Scope	1
Target Group	1
Safety Instructions	1
1. Brief Introduction	2
1.1 Features of the inverter	2
1.2 Interface of the inverter	3
1.3 Packing list	4
2. Installation	6
2.1 Preparation	6
2.2 Mounting the Unit	8
2.3 Battery Connection	9
2.3.1 Battery Power Cable Connection	9
2.3.2 Lithium Battery Connection	9
2.4 CT	10
2.5 AC Input/Output Connection	12
2.6 PV Connection	13
2.7 Generator Connection	13
2.8 Dry Contact Signal control	14
2.9 Parallel Function	15
2.10 Power and EPS ON/OFF	18
3. Working Modes	18
3.1 SNA series inverter modes introduction	18
3.2 Working Modes related setting description	20
3.3 Working as a hybrid inverter. Related settings	21
4. LCD display and settings	22
4.1 RGB Display	22

4.2 LCD Display 22

4.3 Inverter Status Display 24

4.4 LCD Settings25

5. About LCD Settings check the operation 36

6. Monitor System for ECO Hybrid inverter 37

7. Specifications 38

8. Trouble Shooting & Error List 42

Revision History

Version	Date	Description
UM-SNA04001	2024.07.15	First official release.

Information on this Manual

Validity

This manual is valid for the following devices: SNA-EU 12000

Scope

This manual provides the installation, operation and troubleshooting of this unit, please read this manual carefully before installations and operations.

Target Group

For qualified persons and end users. Qualified persons and end users must have the following skills:

- Knowledge about this unit operation.
- Training in deal with the security issues associated with installations and electrical safety.
- Training in the installation and commissioning of electrical devices and installations.
- Knowledge of the applicable local standards and directives.

Safety Instructions

WARNING: This chapter contains important safety and operating instructions. Read and keep this manual for future reference.

- All the operation and connection need to be operated by qualified persons.
- Before using the unit, read all instructions and cautionary marking on the unit. Any damage caused by inappropriate operation is not warranted by Luxpower .
- All the electrical installation must comply with the local electrical safety standards.
- Do not disassemble the unit. Take it to a qualified service center when service or repair is required, incorrect re-assembly may result in a risk of electric shock or fire. Do not open inverter cover or change any components without Luxpower's authorization, otherwise the warranty commitment for the inverter will be invalid.
- To reduce risk of electric shock, disconnect all wirings before attempting any maintenance or cleaning, turning off the unit will not reduce this risk.
- **CAUTION**-To reduce risk of injury, charge only deep-cycle lead-acid type rechargeable batteries and lithium batteries, other types of batteries may burst, causing personal injury and damage.
- **NEVER** charge a frozen battery.
- For optimum operation of this unit, please follow required spec to select appropriate cable size and breaker.
- Please strictly follow installation procedure when you want to disconnect AC or DC terminals, please refer to **INSTALLATION** section of this manual for the details.
- **GROUNDING INSTRUCTIONS** -This unit should be connected to a permanent grounded wiring system, be sure to comply with local requirements and regulation to install this inverter.
- **NEVER** cause AC output and DC input short circuited. Do not connect to the mains when DC input short circuits.

1. Brief Introduction

1.1 Features of the inverter

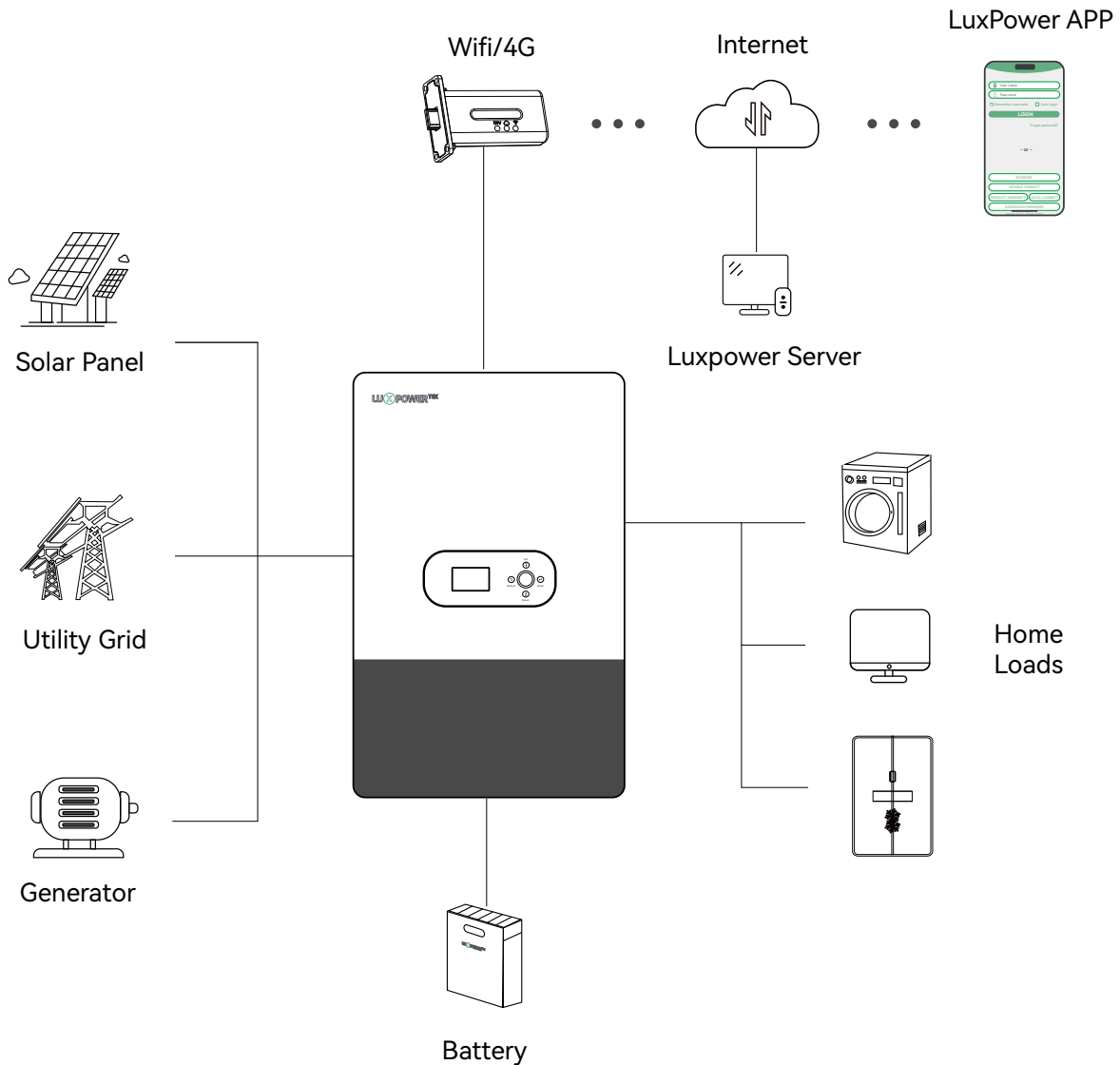

SNA series is a multifunctional, high frequency pure sine wave Offgrid inverter solar inverter, features:

- Applicable for pure off grid inverter/backup power/self-consumption/ongrid situation.
- Integrated with 2MPPT solar charge controllers, MPPT ranges 120V~385V.
- Each PV input MPPT supports up to 12kW, with a total input power of 24kW when both PV inputs are used, and a power factor of 1.
- Be able to run with or without battery in ongrid and offgrid mode.
- With separated generator input interface, able to control generator remotely.
- With integrated advanced parallel function, up to 6pcs max paralleling.
- Support CAN/RS485 for Li-ion battery BMS communication.
- WIFI/GPRS remote monitoring , setting and firmware update, support website, free IOS/Android APP.

1.2 Interface of the inverter

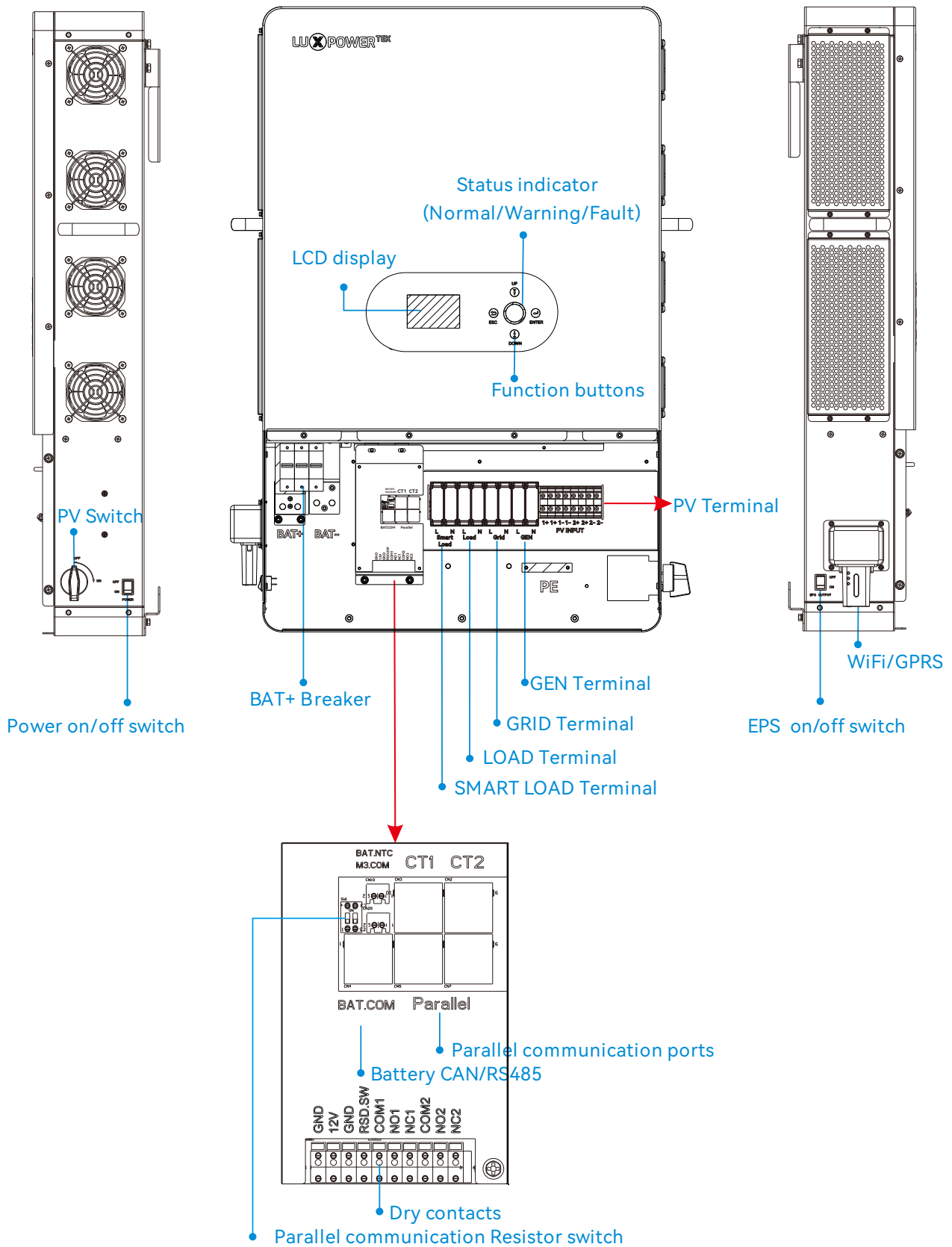

1.3 Packing List

Before installation, please inspect the unit. Be sure that nothing inside the package is damaged. You should have received the following items in the package:

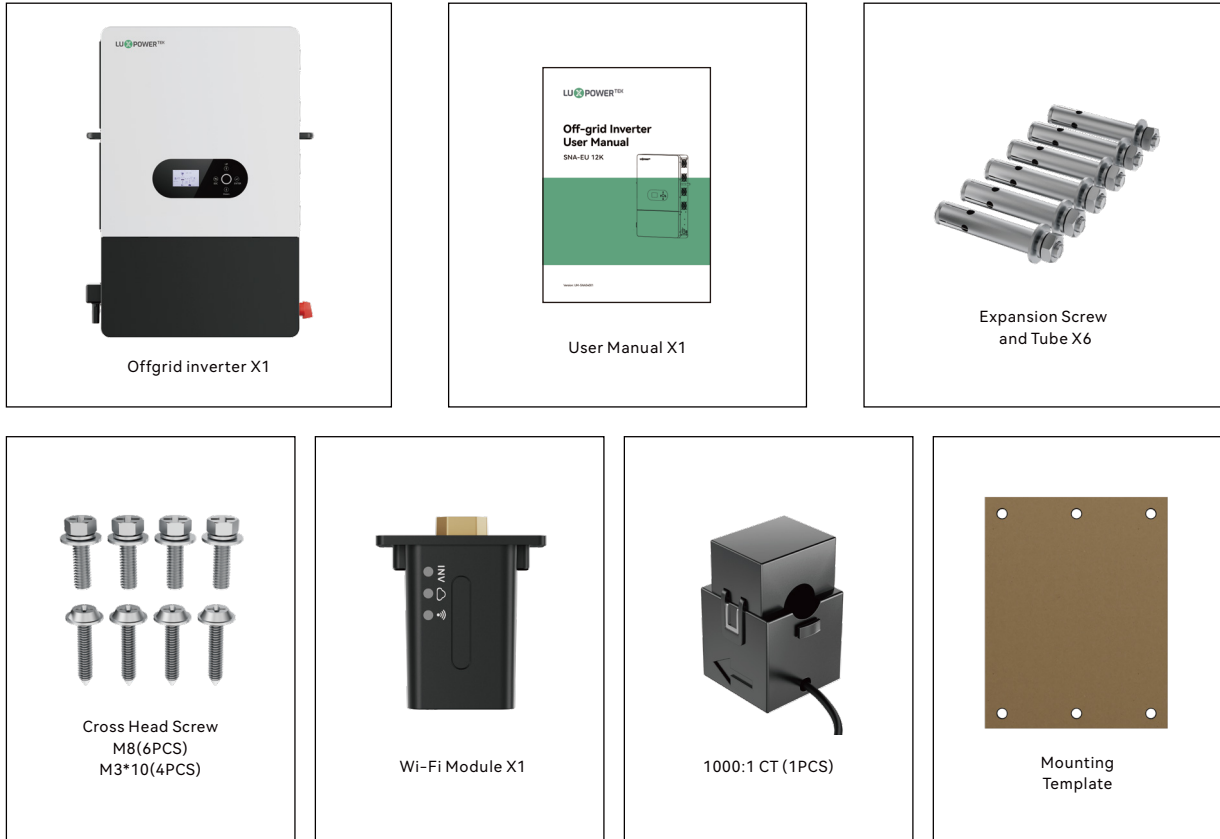

Storing the Inverter

The inverter must be stored appropriately if not installed immediately, refer to below figure.

CAUTION

- a) The inverter and its components must be stored in its original packaging.
- b) The storage temperature should be within -25~60 and humidity within 0~85%.
- c) The packing should be upright and maximum stacked layers is 6.
- d) Do not directly exposed the inverter and its packaging to sunshine, raindrops and keep away from corrosion.

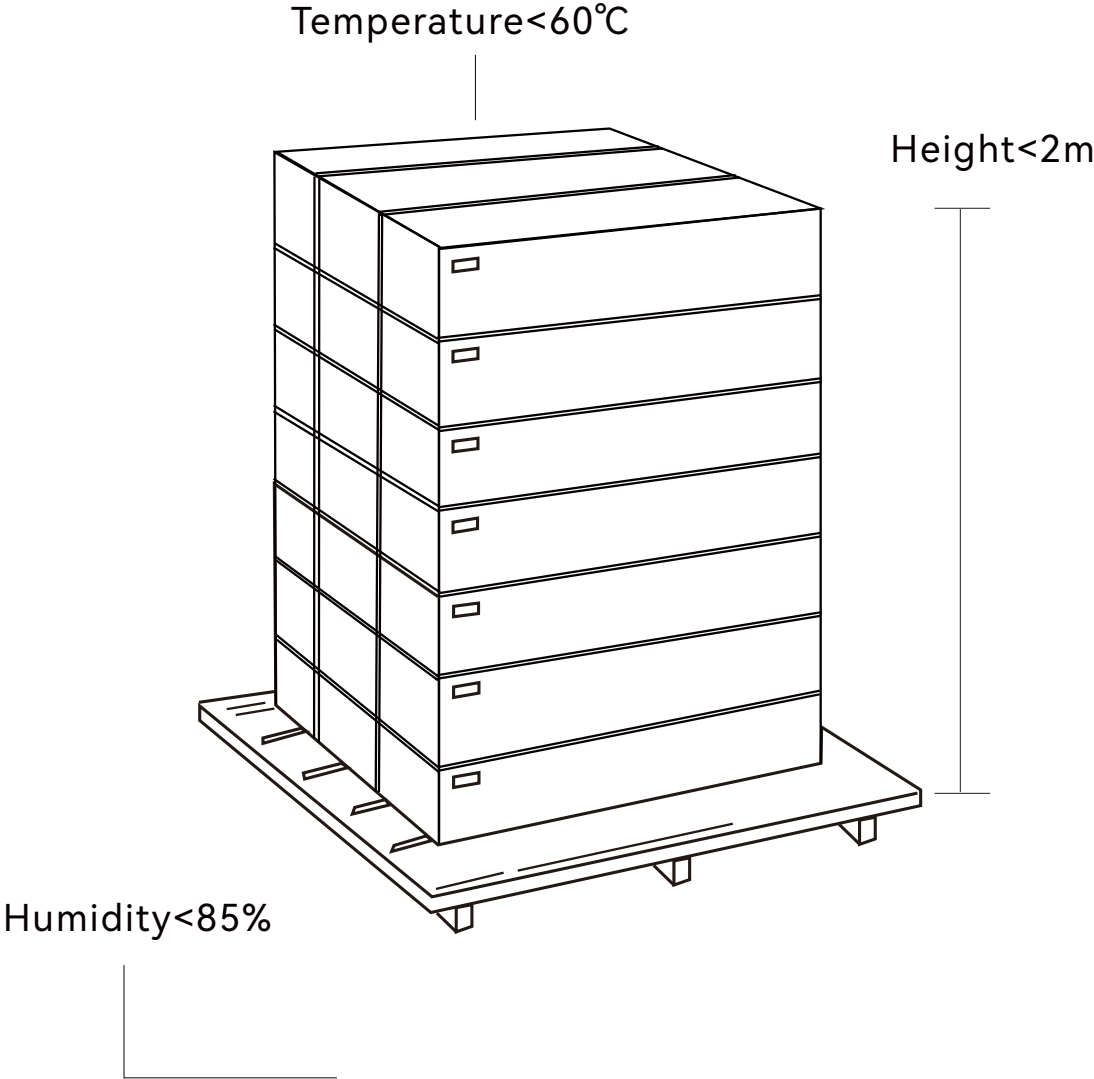

2. Installation

2.1 Preparation

The system connection is as below:

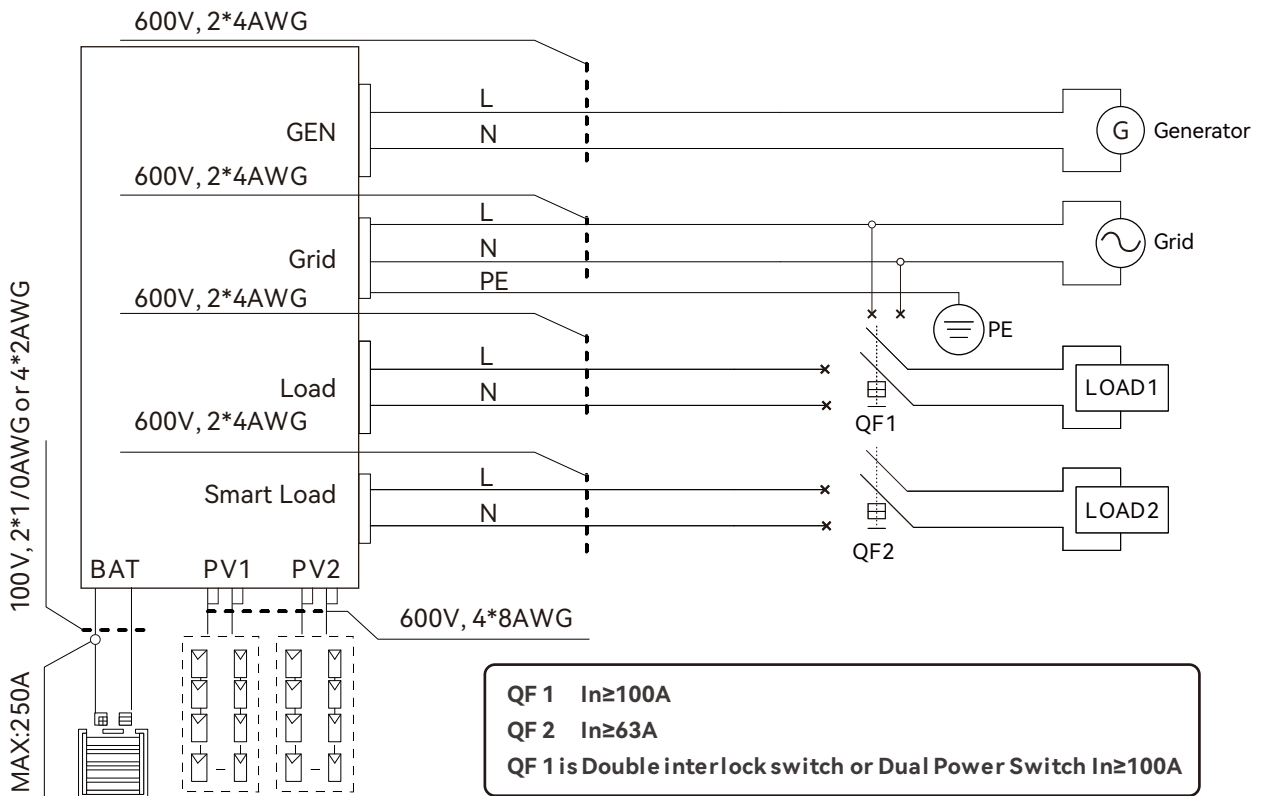

Please prepare the breakers and cables in advanced before installation.

1. Battery connection: For safety operation and regulation compliance, it's requested to install a separate DC over-current protector or disconnect device between battery and inverter. The recommend battery capacity is 400AH, the spec of DC breaker is 300A/80V. Recommended battery cable and terminal size:

Model	Maximum Amperage	Battery capacity	Wire Size	Ring Terminal		Torque value	
				Cable mm ²	Dimensions D (mm) L (mm)		
SNA-EU 12000	250A	400A	1/0AWG	53	8.4 38.8	11-12 Nm	

2. **AC connection:** Please install a separate AC breaker between inverter and AC input power source, inverter and AC output load. This will ensure the inverter can be securely disconnected during maintenance and fully protected from over current of AC input.

Recommended AC input/AC output/GEN cable size for each inverter.

Model	Gauge		Cable (mm ²)	Torque Value
SNA-EU 12000	AC INPUT (GRID side)	4AWG	21	11-12 Nm
	GEN INPUT (GEN side)	4AWG	13	11-12 Nm
	AC OUTPUT (LOAD side)	4AWG	21	11-12 Nm
	AC OUTPUT (SMART LOAD side)	4AWG	13	11-12 Nm

3. **PV Connection:** Please install separately a DC circuit breaker between inverter and PV modules. The spec of DC breaker is 600V/40A. It's very important for system safety and efficient operation to use appropriate cable for PV module connection. To reduce risk of injury, please use the proper recommended cable size as below:

Model	Gauge	Cable (mm ²)	Torque Value
SNA-EU 12000	8AWG	8	11-12 Nm

4. Before connecting all wiring, please take off bottom cover by removing 4 screws as shown below.

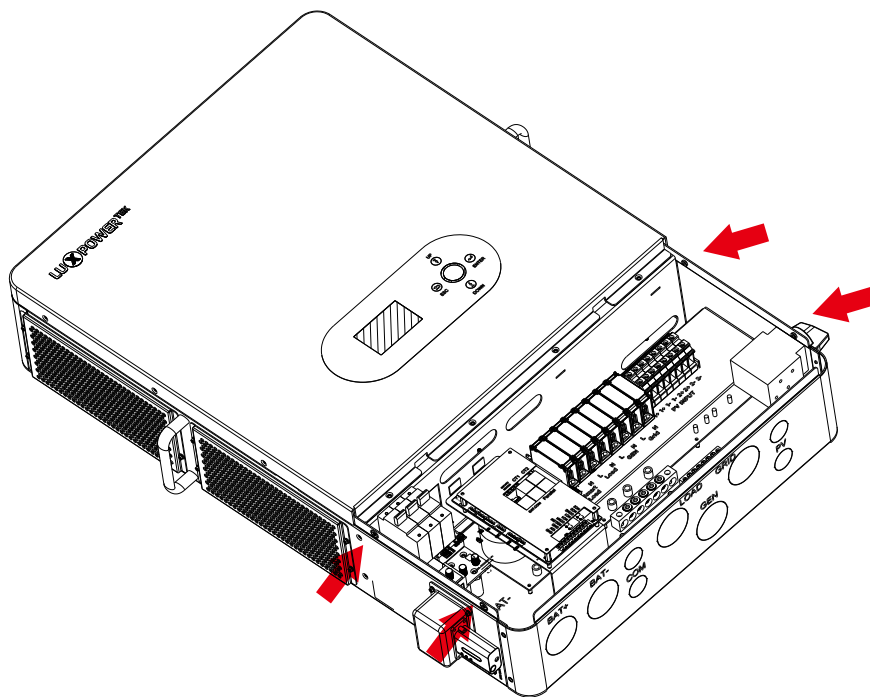

2.2 Mounting the Unit

NOTICE

Consider the following points before selecting where to install:

- Mount on a solid surface.
- Do not mount the inverter on flammable construction materials.
- For proper air circulation to dissipate heat, allow a clearance of approx. 20cm to the side and approx. 50cm above and below the unit.
- The ambient temperature should be between 0°C and 55°C to ensure optimal operation.
- The recommended installation position is to be adhered to the wall vertically.

Steps to mounting the unit

Step 1. Use the wall-mounting bracket as the template to mark the position of the 4 holes, then drill 8 mm holes and make sure the depth of the holes is deeper than 50mm.

Step 2. Install the expansion tubes into the holes and tighten them, then use the expansion screws (packaged together with the expansion tubes) to install and fix the wall-mounting bracket on the wall.

Step 3. Install the inverter on the wall-mounting bracket and lock the inverter using the security screws.

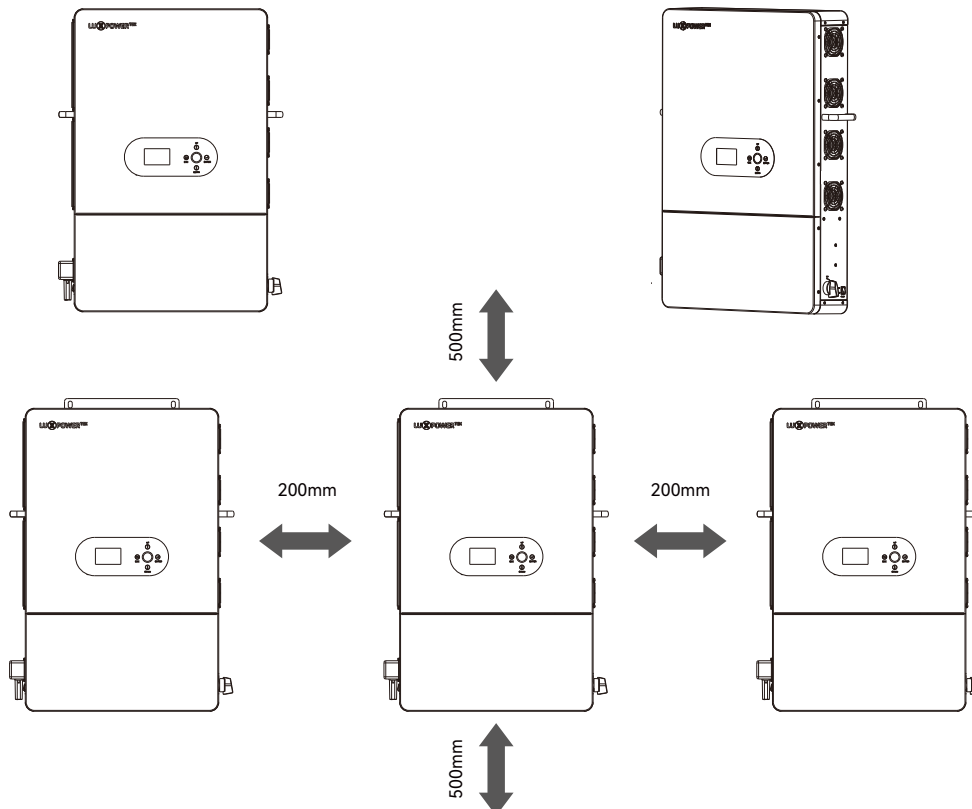

2.3 Battery Connection

2.3.1 Battery Power Cable Connection

Note: for lead acid battery, the recommended charge current is 0.1-0.25C (C to battery capacity).

1. Please follow below steps to implement battery connection:
2. Assemble battery ring terminal based on recommended battery cable and terminal size.
3. Connect all battery packs as units requires. It's suggested to connect at least 400Ah capacity battery for SNA-EU 12000.
4. Insert the ring terminal of battery cable flatly into battery connector of inverter and make sure the bolts are tightened with torque of 11-12Nm. Make sure polarity of the battery is correctly connected and ring terminals are tightly screwed to the battery terminals.

2.3.2 Lithium Battery Connection

If choosing lithium battery for SNA series, please make sure the battery BMS is compatible with Luxpower inverter. Please check the compatible list in the Luxpower website.

Please follow below steps to implement lithium battery connection:

1. Connect power cable between inverter and battery.
2. Connect the CAN or RS485 communication cable between inverter and battery. If you do not get the communication cable from inverter manufacturer or battery manufacturer, please make the cable according to the PIN definition.
3. Lithium battery configuration, in order to communicate with battery BMS, you should set the battery type to “Li-ion” in Program “03” by LCD and choose the right battery brand (for details, please check the LCD setting chapter), users can also choose the battery type and brand by monitor system.

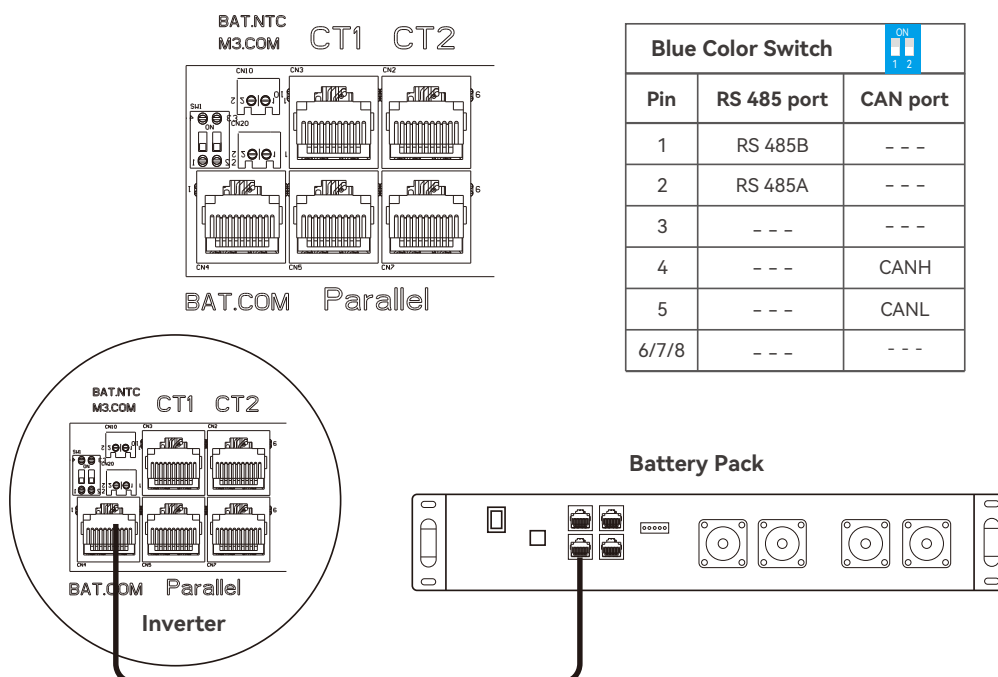

2.4 CT

To measure the power imported from and exported to the grid, the CT must be installed at the service entry point in or near the main service panel. "External Grid CT" function is off by default, and if you need inverter to export power to compensate the grid loads, you can set "External Grid CT" function to "Enable" state. Please refer to section 4.4 LCD Settings for detected setting info.

CT1 Port Pin definitio

The CT1 interface for CT1 connection is a RJ45 port.

Pin	Description
	CT1
1/3	B
2/4	A
5	CT1N
6	CT1P
7	B2
8	A2

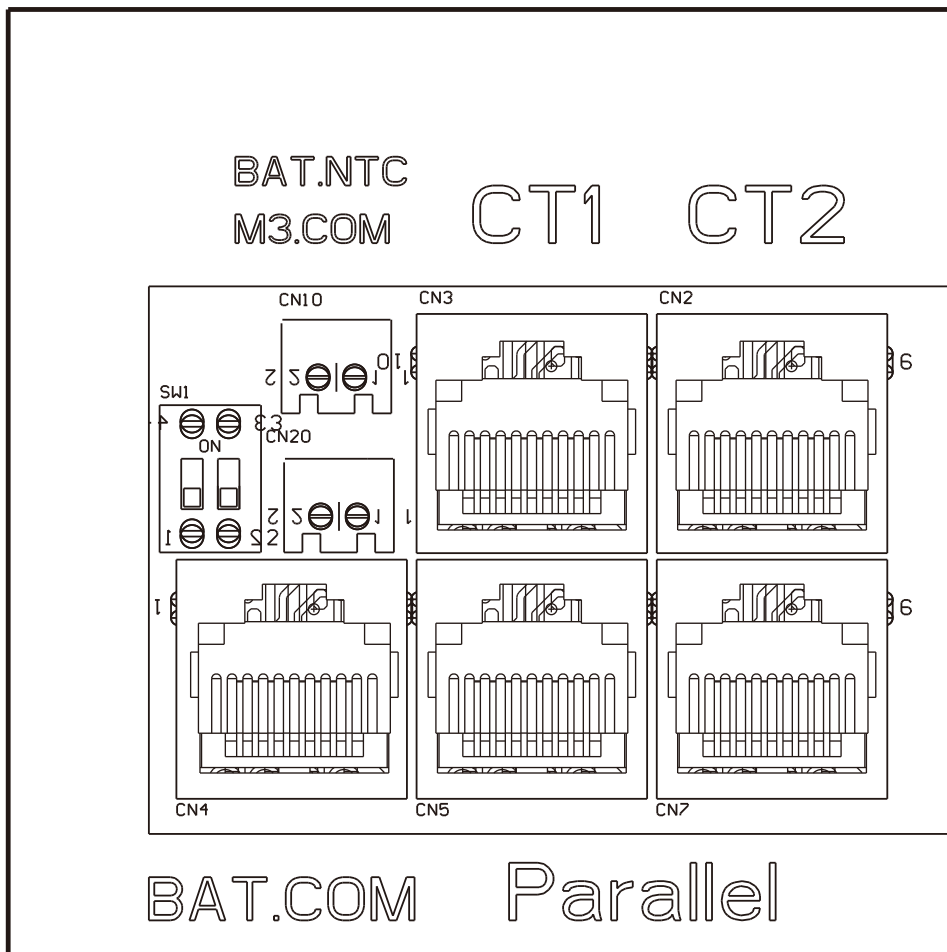
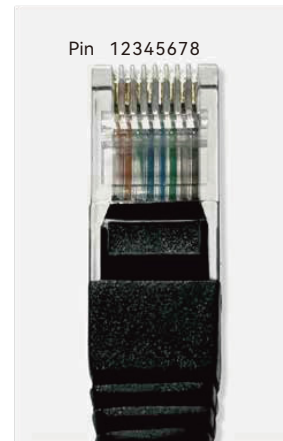

Please refer to the connection diagram for the correct positions of Grid CT and clamp the CT on the wires at the service entry point in the main service panel. The arrow on the CT is pointing to the inverter. (***) Incorrectly install CT will cause the display to show incorrect information and features of the inverter will not function correctly) If the CT is in a wrong direction, there is an option you can change the direction of the CT on your inverter call: CT Direction Reversed in Advanced Tab. You would not need to go change it physically.

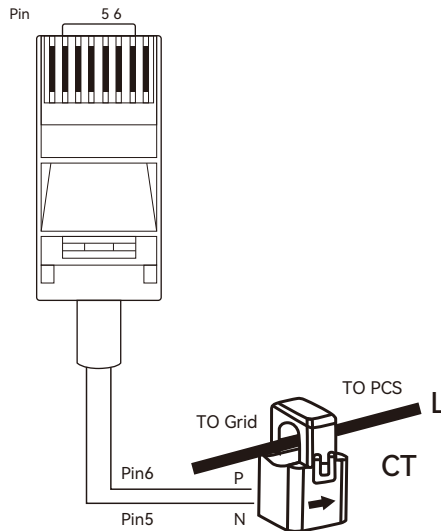

CT Clamp Ratio

The inverter support 3 ratios of CT clamp-**1000:1**, **2000:1** and **3000:1**. The CT ratio of the CT in the accessory bag is 1000:1. If you are using a 3rd party CT, please ensure the CT ratio is one of them, and select the correct CT ratio setting in the inverter monitor page or on the inverter LCD.

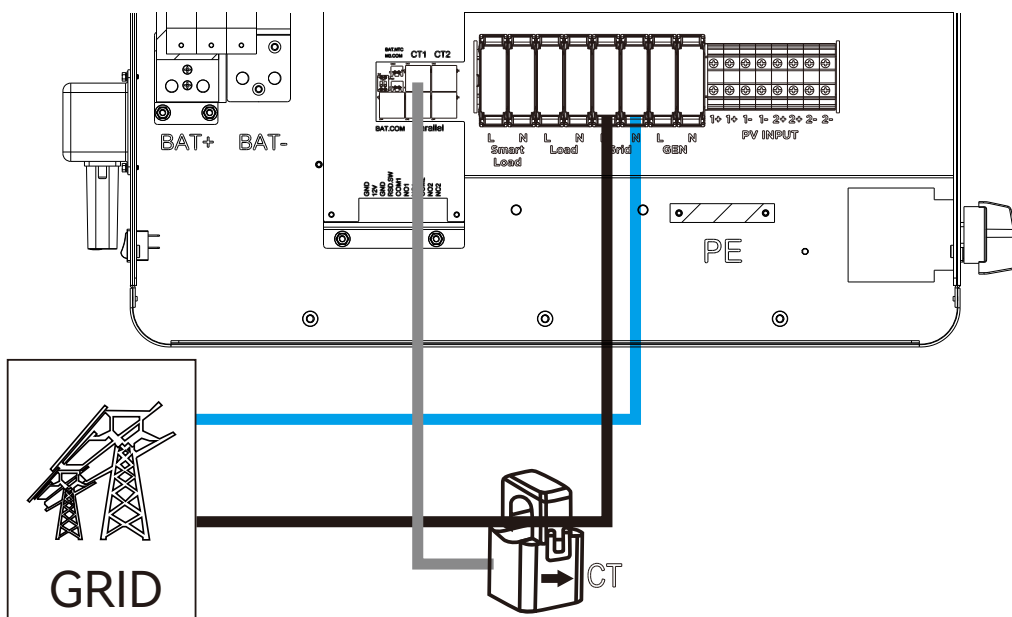

2.5 AC Input/Output Connection

! CAUTION

- There are two terminal blocks with “IN” and “OUT” markings. Please do NOT mis-connect input and output connectors.
- Be sure to connect AC wires with correct polarity. If L and N wires are connected reversely, it may cause utility short-circuited when these inverters are worked in parallel operation.

Please follow below steps to implement AC input/output connection:

1. Before making AC input/output connection, be sure to open DC protector or disconnected first.
2. Remove insulation sleeve 10mm for six conductors. And shorten phase L and neutral conductor N 3mm.
3. Insert AC input wires according to polarities indicated on terminal block and tighten the terminal screws. Be sure to connect PE protective conductor first.
4. Insert AC output wires according to polarities indicated on terminal block and tighten terminal screws. Be sure to connect PE protective conductor first.
5. Make sure the wires are securely connected.

⊕ → Ground (yellow-green)

L → LINE (brown or black)

N → Neutral (blue)

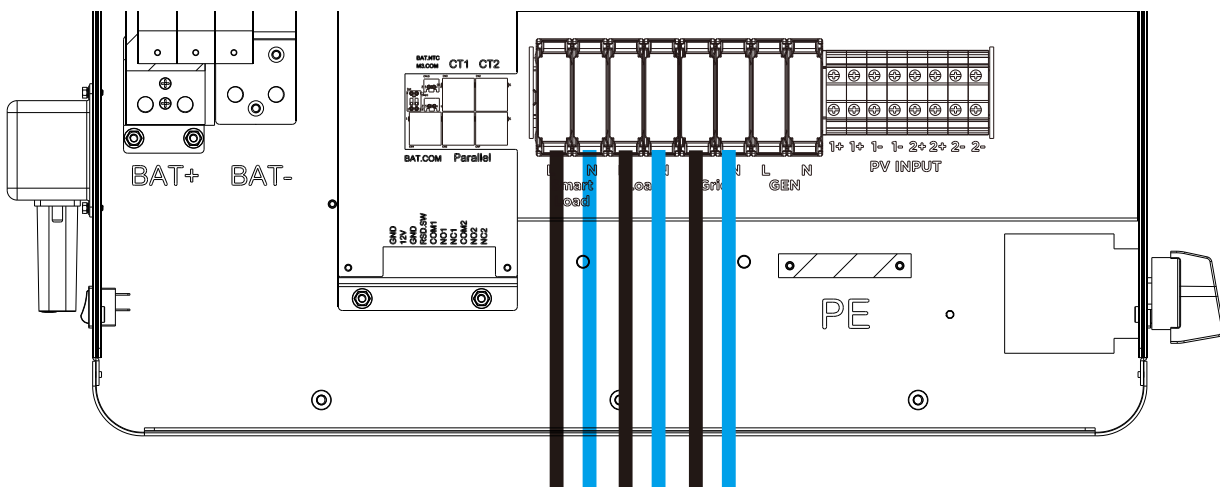
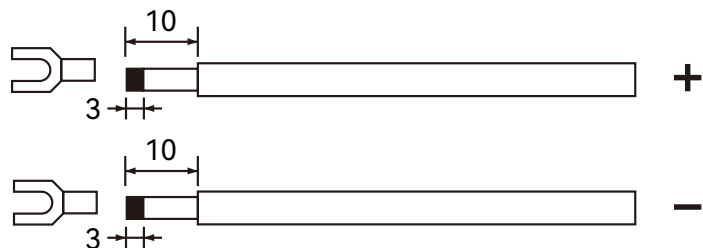

2.6 PV Connection

Please follow below steps to implement PV module connection:

1. Remove insulation sleeve 10 mm for positive and negative conductors.
2. Check correct polarity of connection cable from PV modules and PV input connectors.
3. Connect positive pole (+) of connection cable to positive pole (+) of PV input connector. Connect negative pole (-) of connection cable to negative pole (-) of PV input connector.
4. Make sure the wires are securely connected.

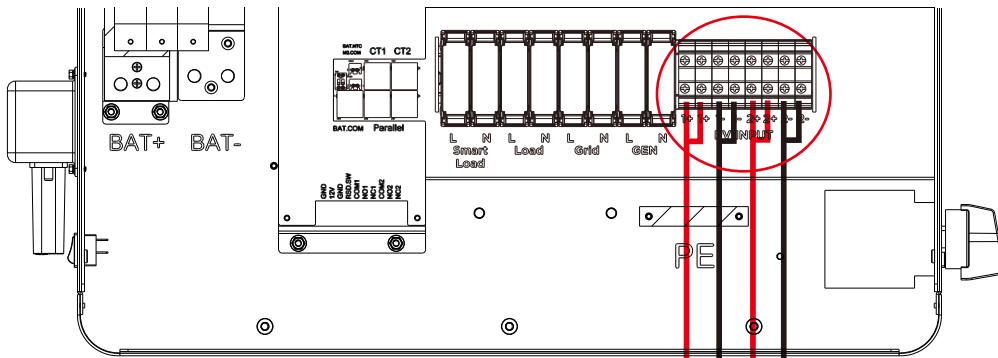

2.7 Generator Connection

L→LINE (brown or black) N→Neutral (blue)

1. Before making Generator connection, be sure to open DC protector or disconnected first.
2. Remove insulation sleeve 10mm for 2 conductors.
3. Insert L and N wires according to polarities indicated on terminal block and tighten the terminal screws.
4. Make sure the wires are securely connected.
5. Finally, after connecting all wiring, please put bottom cover back by screwing two screws as shown below.

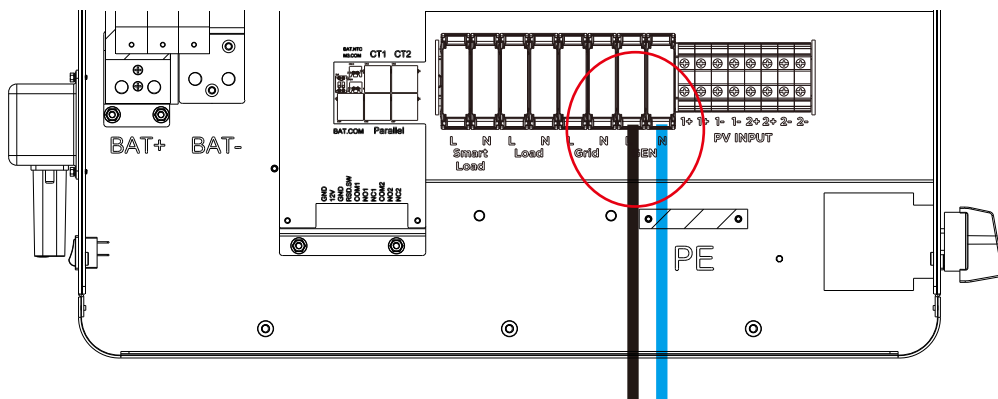

All lux units can work with generator:

- Users can connect the generator output to the SNA series inverters via the GEN input terminal.
- The generator automatically starts when the battery voltage falls below the cut-off value or when there is a charge request from the BMS. It stops once the voltage exceeds the AC charge setting value.
- When the generator is on, it charges the battery and is bypassed to the AC output to take all loads.

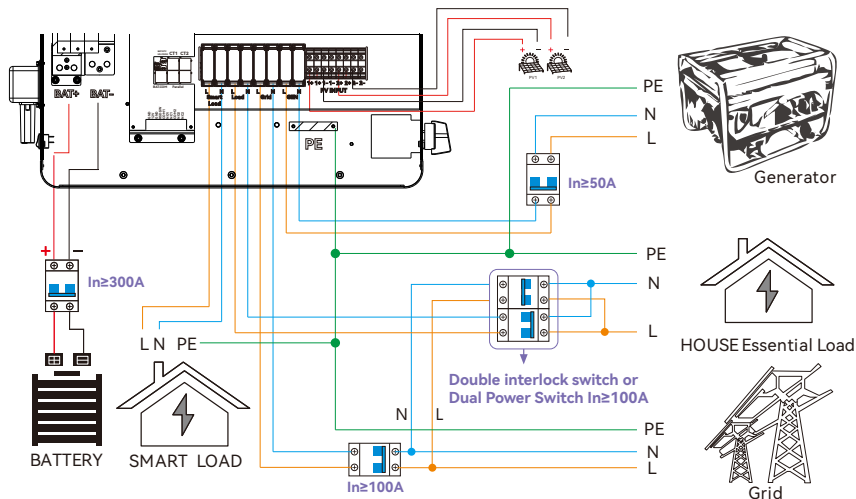

- The system will use AC first if there is both utility input and generator input.

The capacity of the generator is recommended.

Number of the single parallel inverter	Capacity
Single inverter	>15KW
2 parallel	>30KW

It is supported to parallel 2~3 PCS inverter with single phase in single phase parallel system and three phase parallel system to charge battery with Generator! And it is depends on the load performance of the generator too.

2.8 Dry Contact Signal control

The Dry port (NO2, COM2) could be used to deliver signal to external device when battery voltage reaches warning level. The GEN port (NO1, COM1) could be used to wake-up the Generator and then the generator can charge the battery.

Unit Status	Condition	Dry port NO2 COM2	GEN NO1 COM1	
		NO2 & COM2	NO1 & COM1	
Power Off	The inverter is off and no output is being powered.	Open	Open	
Power On	Without Grid	Battery voltage < Low DC warning voltage	Close	
		Battery voltage > Setting value or battery charging reaches floating stage	Open	
	With Grid	Battery voltage < Low DC warning voltage	Close	Open
		Battery voltage > Setting value or battery charging reaches floating stage	Open	Open

Notice: NO---Normal open

Dry Port Relay Maximum Specification: 250VAC 5A
Gen Port Relay Maximum Specification: 250VAC 5A

2.9 Parallel Function

SNA series inverter support up to 6 units to composed single phase parallel system or three phase parallel system, for parallel system setup.

Step 1. Cable connection: the system connection is as below:

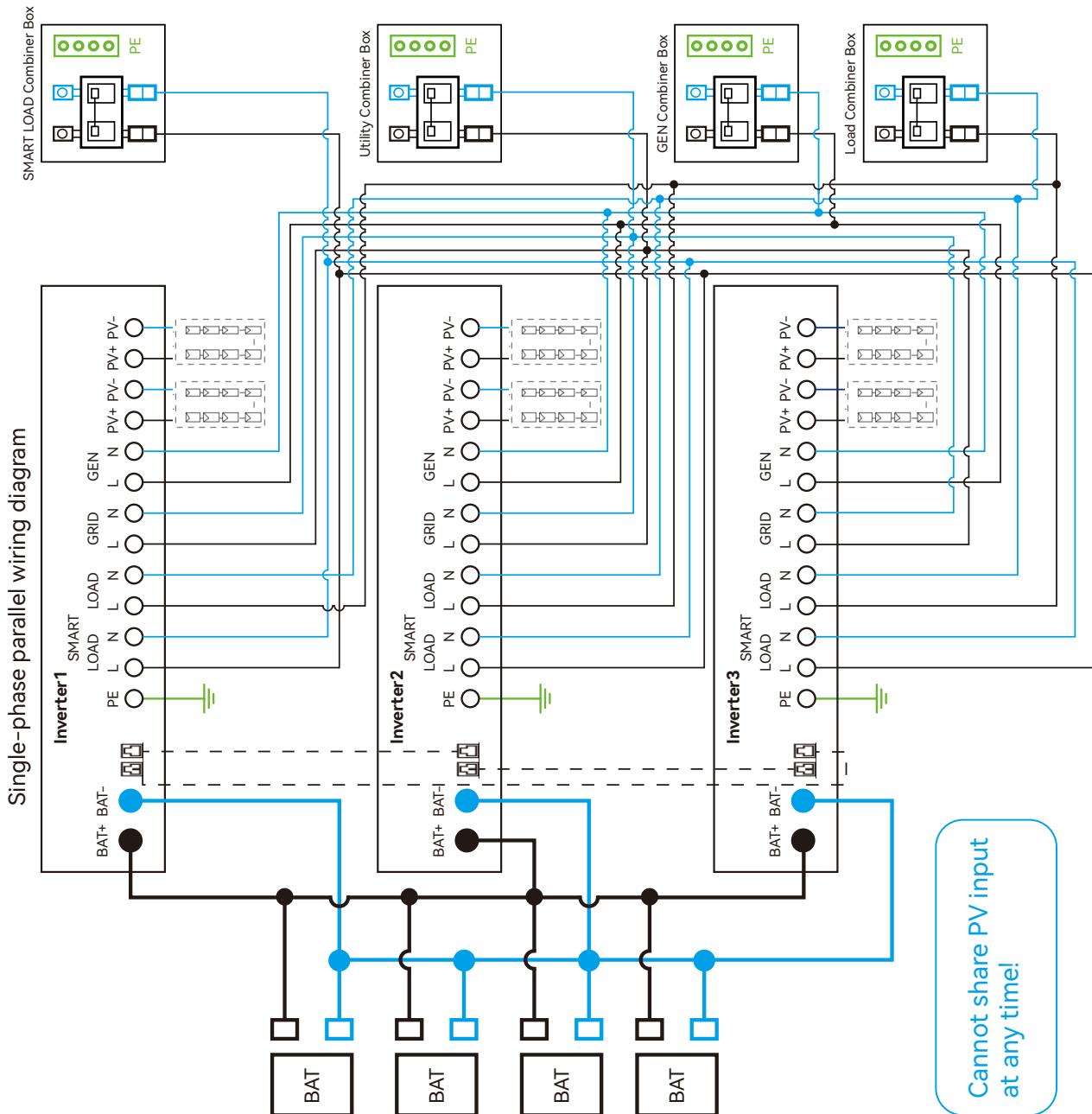

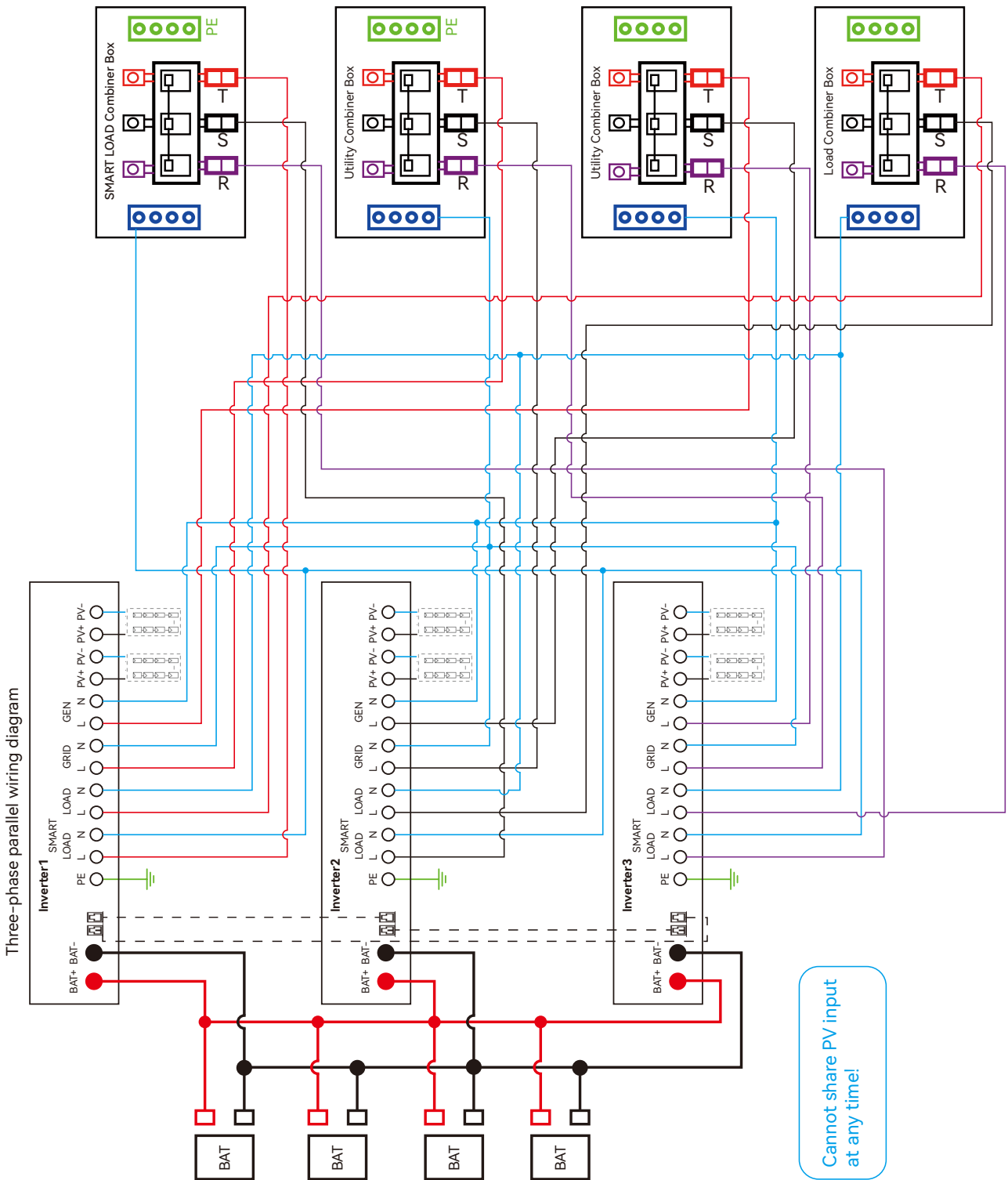

Step 2. Please put the CAN communication PIN to on status for the first and the end inverter.

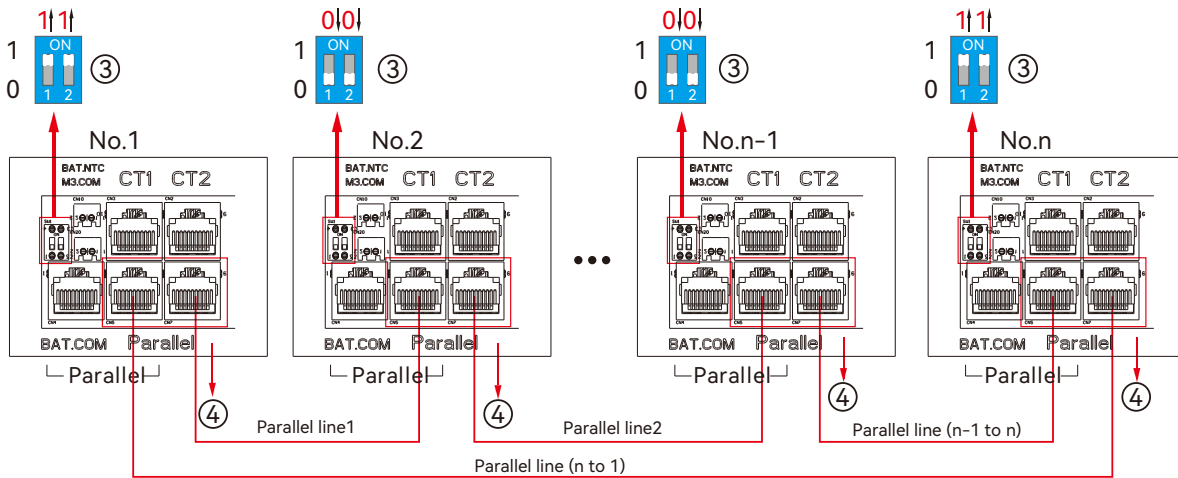

The max parallel quantity is 10, so $2 \leq n \leq 10$

Step 3. Setup the monitor for the system, add all datalogs in one station. Users can login to the visit interface of monitor system, Configuration->station->Plant Management->add datalog to add the datalogs.

LU X POWER TEK Monitor Data Configuration Overview Maintenance Asia English shawou distributor

Stations + Add Station Search by station name X

Plant name	Installer	End User	Country	Timezone	Daylight saving time	Create date	Action
1 Genesis		Aspergo Install	South Africa	GMT+2	No	2019-03-14	Station Management
2 Butler Home	Elangeni	johnbutler	South Africa	GMT+2	No	2019-03-25	Station Management
3 Office			South Africa	GMT+2	No	2019-06-03	Station Management
4 Cronje Home	Broomhead	cronje	South Africa	GMT+2	No	2019-07-16	Station Management

Step 4. Enable share battery for the system if the system share one battery bank, otherwise disable the shared battery function.

Step 5. Set the system as a parallel group in the monitor system.

LU X POWER TEK Monitor Data Configuration Overview Maintenance Asia English shawou distributor

Stations Overview Station Name Search by inverter SN X

Device Overview

Serial number	Status	Solar Power	Charge Power	Discharge Power	Load	Solar Yield	Battery Dischar	Feed Energy	ConsumptionEr	Station name	Parallel	Action
1 0272011008	Normal	228 W	42 W	0 W	182 W	215.3 kWh	39.6 kWh	0 kWh	551.2 kWh	Dragonview	A-1	Parallel
2 0272011011		35 W	32 W	0 W	0 W	158.7 kWh	21.1 kWh	0 kWh	160.5 kWh	Dragonview	A-2	Parallel
3 0272011012		1 kW	129 W	0 W	1 kW	170.3 kWh	49.9 kWh	0 kWh	434.5 kWh	Dragonview	A-3	Parallel
4 0272011017		79 W	48 W	0 W	106 W	99 kWh	85.6 kWh	0 kWh	257.1 kWh	Dragonview	A-4	Parallel

For more detailed guidance for paralleling system, please visit <https://www.luxpowertek.com/download/> And download the guidance.

2.10 Power and EPS ON/OFF

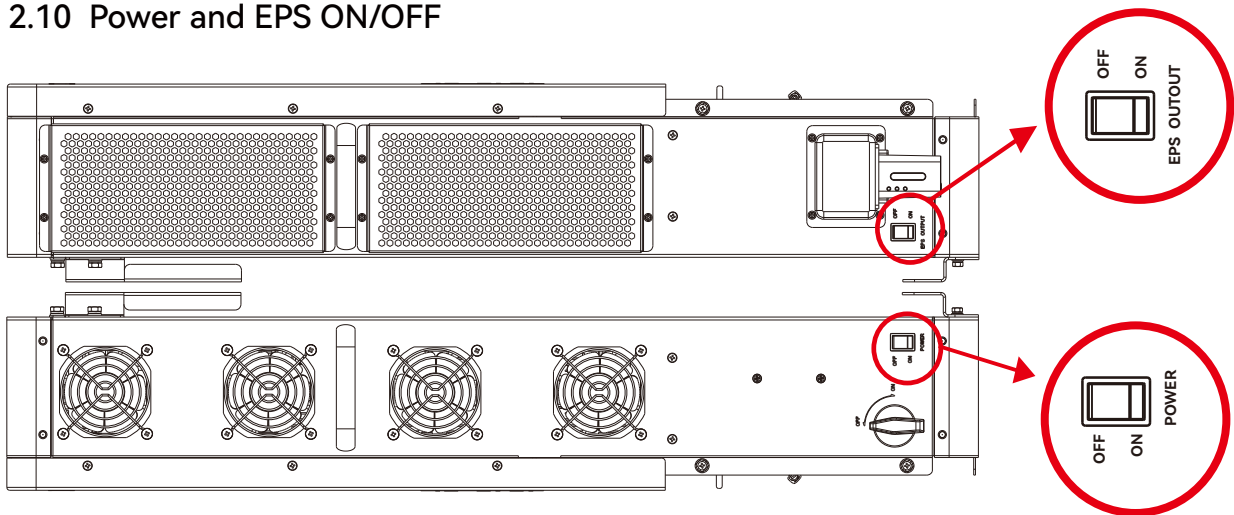

1. Power Switch: Control power supply for the unit
2. LOAD Output Switch: Use to control the AC output

After connection, please turn on both switch. Users can turn off the LOAD output switch to turn off power supply in some emergency case.

3. Working modes

3.1 SNA series inverter modes introduction:

<p>Bypass Mode</p>		<p>AC is used to take the load.</p>
<p>PV Charge Bypass</p>		<p>PV charge the battery while the AC power the load.</p>
<p>BAT Grid off</p>		<p>Battery is used to take the load.</p>

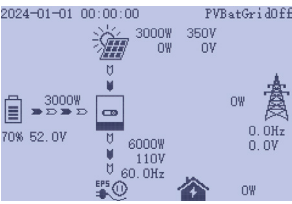
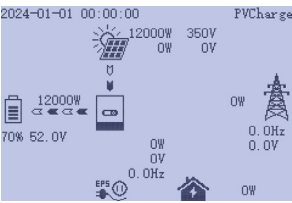
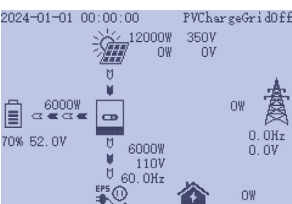
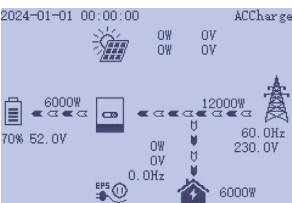
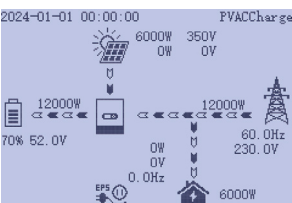
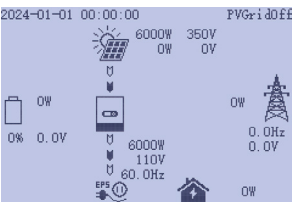
<p>PV+BAT Grid off</p>		<p>PV+Battery power the load together.</p>
<p>PV Charge</p>		<p>1. When the LOAD key off, the inverter charge the battery only. 2. When the battery is power off, the PV can wake up the battery automatically.</p>
<p>PV Charge+Grid off</p>		<p>PV charge the battery and power the load.</p>
<p>AC Charge</p>		<p>1. AC charge the battery from AC Input or GEN Input. 2. When the battery is power off, the AC can wake up the battery automatically.</p>
<p>PV+AC charge</p>		<p>PV+AC charge the battery. AC is from AC Input or GEN Input.</p>
<p>PV Grid off</p>		<p>NOTE: The output power depends on the PV energy input, if the PV energy is unstable, witch will influence the output power.</p> <p>When setting without battery, the PV can power the load.</p>

3.2 Working Modes related setting description

Situation	Setting 1	Setting 2	Setting 3	Working modes and Description	
AC abnormal	NA	NA	NA	off grid inverter mode if $P_{Solar} > P_{load}$, solar is used to take load and charge battery if $P_{Solar} < P_{load}$, solar and battery take the load together, system will discharge until battery lower than the Cut Off Voltage/SOC.	
AC normal	PV&AC Take Load Jointly Enable	In the AC first time	NA	Hybrid Mode 1 (charge first) Solar power will be used to charge battery first, 1. The solar power will be used to charge the battery first. AC will take load. 2. if solar power is higher than power need to charge the battery, the extra power will be used to take load together with grid. 3. If there is still more energy after charge battery and take the load, it will feed energy into grid if export to grid function is enabled.	
		Enable AC charge and in the AC charge time	AC charge according to Time	Hybrid Mode 1 (charge first)+AC charge battery if solar power is not enough to charge battery.	
	PV&AC Take Load Jointly Disable	1. Not in the AC first time and 2. Disable AC charge or not in the AC charge time	NA	NA	Hybrid Mode 1 (charge first)+AC charge battery if solar power is not enough to charge battery and the battery voltage/SOC is lower than AC start charge voltage/SOC, the AC will stop charging when the battery Voltage/SOC is higher than AC end charge battery voltage/SOC.
		In the AC first time	NA	NA	Hybrid Mode 2 (load first) Solar power will be used to take load first, 1. if solar power is lower than load, battery will discharge together to take load until battery lower than EOD voltage/SOC. 2. if solar power is higher than load, the extra power will be used to charge battery, if there is still more energy, it will feed into grid if enable export.
		In the AC first time	NA	Bypass Mode AC will take the load and Solar is used to charge battery.	
		Enable AC charge and in the AC charge time	AC charge according to Time	Bypass Mode+AC charge battery/Solar is used to charge battery. AC will take load and also charge battery during AC charge time if solar power is not enough.	
		1. Not in the AC first time and 2. Disable AC charge or not in the AC charge time	NA	Bypass Mode+AC charge battery Solar is used to charge battery. AC will take load and also charge battery when battery SOC/Voltage is lower than start SOC/Voltage, and the AC will stop charging when the battery Voltage/SOC is higher than AC end charge battery voltage/SOC.	
		In the AC first time	NA	off grid inverter mode if $P_{Solar} > P_{load}$, solar is used to take load and charge battery if $P_{Solar} < P_{load}$, solar and battery take the load together, system will discharge until battery lower than EOD Voltage/SOC.	

3.3 Working as a hybrid inverter. Related settings

3.3.1 The SNA series can function as a traditional off-grid inverter or a hybrid inverter. When PV&AC take load jointly is disabled, it operates as a traditional off-grid inverter. Otherwise, it works as a hybrid inverter. In this mode, the inverter either uses solar and battery to power the load or uses AC to take the load.

Hybrid Setting

PV&AC Take Load Jointly	<input type="button" value="Enable"/> <input type="button" value="Disable"/>
Export to Grid	<input type="button" value="Enable"/> <input type="button" value="Disable"/>
CT Power Offset(W)	<input type="text" value="[-199,199]"/> <input type="button" value="Set"/>
Export Power Percent(%)	<input type="text" value="[0,100]"/> <input type="button" value="Set"/>

3.3.2 AC First: During the setting time, system will use AC to take load, use solar power to charge the battery first. If there is extra solar power, extra solar power will take the load. When out of the setting time, system will use solar and battery to take load first until battery voltage/SOC is lower than On Grid EOD settings, then it will use AC to take the load.

	Start		End
T1	<input type="text" value="[0,23]"/> : <input type="text" value="[0,59]"/> <input type="button" value="Set"/>	—	<input type="text" value="[0,23]"/> : <input type="text" value="[0,59]"/> <input type="button" value="Set"/>
T2	<input type="text" value="[0,23]"/> : <input type="text" value="[0,59]"/> <input type="button" value="Set"/>	—	<input type="text" value="[0,23]"/> : <input type="text" value="[0,59]"/> <input type="button" value="Set"/>
T3	<input type="text" value="[0,23]"/> : <input type="text" value="[0,59]"/> <input type="button" value="Set"/>	—	<input type="text" value="[0,23]"/> : <input type="text" value="[0,59]"/> <input type="button" value="Set"/>

Discharging

Batt Discharge Control	<input type="button" value="Volt"/> <input type="button" value="SOC"/>
Discharge Current Limit(Adc)	<input type="text" value="[0,250/65534]"/> <input type="button" value="Set"/>
Battery Warning Voltage(V)	<input type="text" value="[40,50]"/> <input type="button" value="Set"/>
Battery Warning SOC(%)	<input type="text" value="[0,90]"/> <input type="button" value="Set"/>

Off-Grid Cut-Off SOC(%)	<input type="text" value="0"/> <input type="button" value="Set"/>
On-Grid Cut-Off SOC(%)	<input type="text" value="7"/> <input type="button" value="Set"/>
Off-Grid Cut-Off Volt(V)	<input type="text" value="40"/> <input type="button" value="Set"/>
On-Grid Cut-Off Volt(V)	<input type="text" value="41"/> <input type="button" value="Set"/>

3.3.3 AC Charge function Disable: The system will not use AC to charge the battery (except Li ion BMS set force charge flag).

AC Charge Battery Current(A)	<input type="text" value="[0,250]"/> <input type="button" value="Set"/>
AC Charge Based On	<input type="text" value="<Empty>"/> <input type="button" value="Set"/> <div style="border: 1px solid black; padding: 2px; margin-top: 5px;"> <Empty> Disable Time(According to) Battery Voltage(According to) Battery SOC(According to) Battery Voltage and Time(According to) Battery SOC and Time(According to) </div>

	Start		End
T1	<input type="text" value="[0,23]"/> : <input type="text" value="[0,59]"/> <input type="button" value="Set"/>	—	<input type="text" value="[0,23]"/> : <input type="text" value="[0,59]"/> <input type="button" value="Set"/>
T2	<input type="text" value="[0,23]"/> : <input type="text" value="[0,59]"/> <input type="button" value="Set"/>	—	<input type="text" value="[0,23]"/> : <input type="text" value="[0,59]"/> <input type="button" value="Set"/>
T3	<input type="text" value="[0,23]"/> : <input type="text" value="[0,59]"/> <input type="button" value="Set"/>	—	<input type="text" value="[0,23]"/> : <input type="text" value="[0,59]"/> <input type="button" value="Set"/>

- According to Time: During the setting time, system will use AC to charge the battery until battery full and battery will not discharge during the setting time.
- According to Battery Voltage: During the setting voltage, system will use AC to charge the battery if battery voltage is lower than AC Charge Start Battery Voltage and will stop when Voltage is higher than AC Charge End Battery Voltage.
- According to Battery SOC: During the setting SOC, system will use AC to charge the battery if battery SOC is lower than AC Charge Start Battery SOC and will stop when Voltage is higher than AC Charge End Battery SOC.
- According to Battery Voltage and Time: During the setting time, system will use AC to charge the battery if battery voltage is lower than AC Charge Start Battery Voltage and will stop when Voltage is higher than AC Charge End Battery Voltage. And battery will not discharge during the setting time.
- According to Battery SOC and Time: During the setting time, system will use AC to charge the battery if battery SOC is lower than AC Charge Start Battery SOC and will stop when Voltage is higher than AC Charge End Battery SOC. And battery will not discharge during the setting time.

4. LCD display and settings

4.1 RGB Display

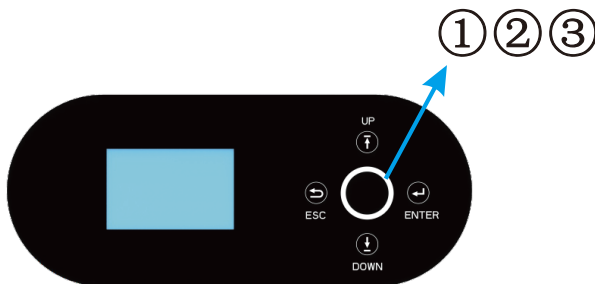

LED Indicator			Messages
1	Green	Rotate	Normal
2	Yellow	Rotate	Warning
3	Red	Rotate	Fault

4.2 LCD Display

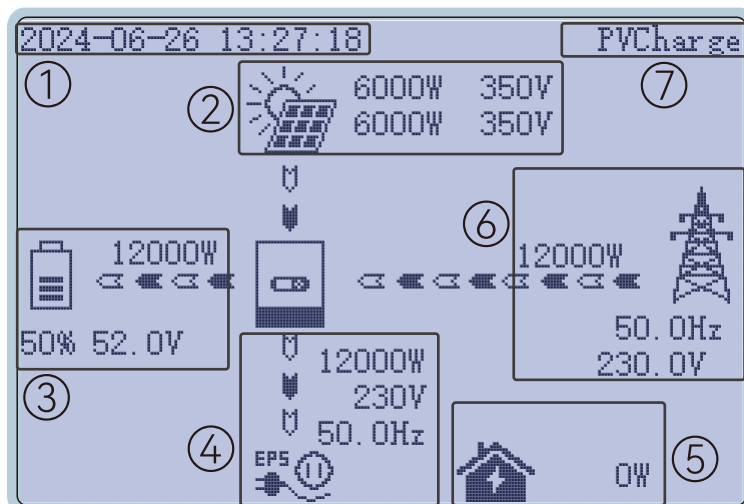

NO.	Description	Remarks
1	Generally Information Display Area	Display the currently time/date by default.
2	Solar inverter output power	This area shows the data of Two-channel PV voltage and power.
3	Battery information and data	This area shows the battery type, (lithium battery or lead Acid battery), display the voltage, SOC , input and output power.
4	LOAD output information and data	This area will display LOAD voltage, frequency, power.
5	Loads consumption	Display the power consumption by the loads in on grid model.
6	Grid information and Generator information	Display the grid (Power pylon) information of voltage, frequency, input or output power, the Generator (dynamo) information of voltage, frequency, input power.
7	Working status text display area	This area displays the status code of the SNA-EU 12000 inverter, including rated running status text, the code for the alarm and the code error.

4.3 Inverter Status Display

When the SNA-EU 12000 inverter is running normally, the text information corresponding to the current working status is displayed in the red box, such as PVGridOn or PVCharge.

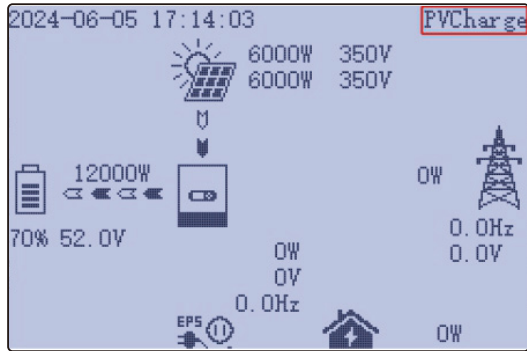

Warning Status, warning 04

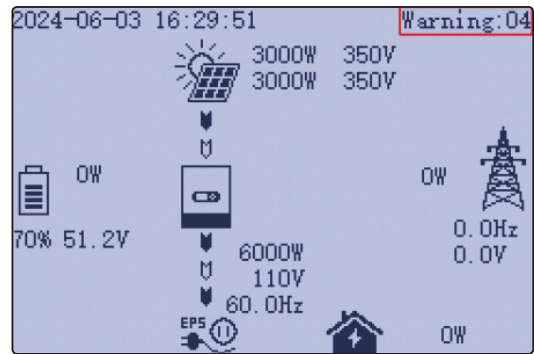

Fault status, fault 02

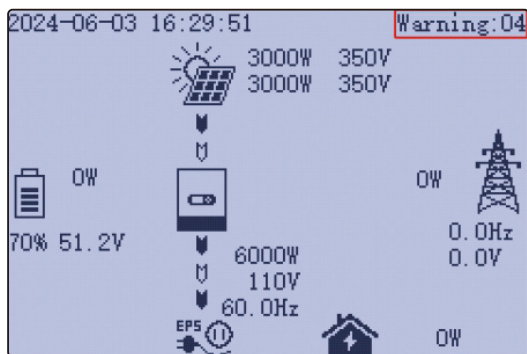

Flash status: download percent is 58%

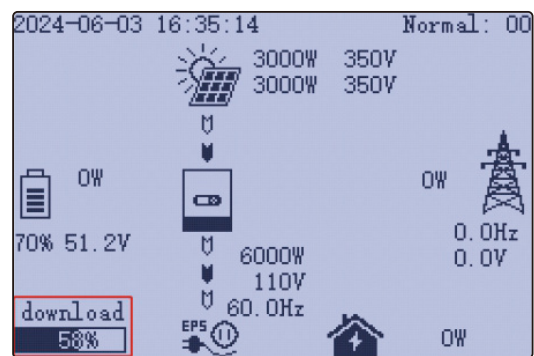

If the system displays the icon in the red box. Indicates that the AC input port is connected to the power grid.

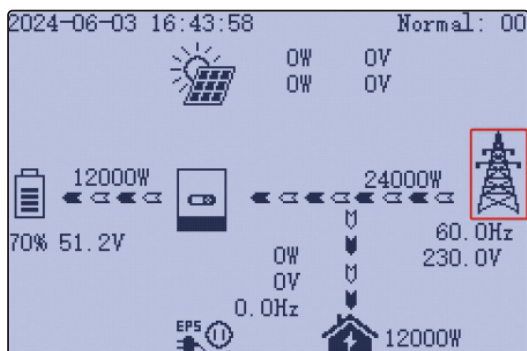

When the icon in the red box is displayed, it indicates that the AC input port is connected to a generator.

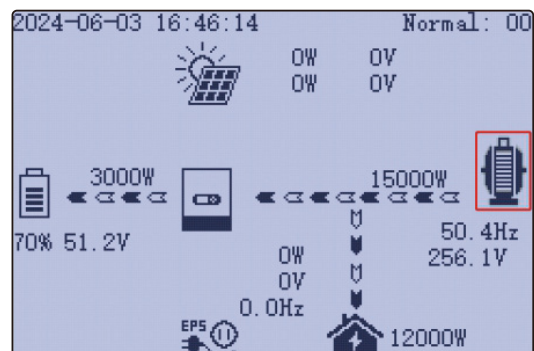

4.4 LCD Settings

Button Operations

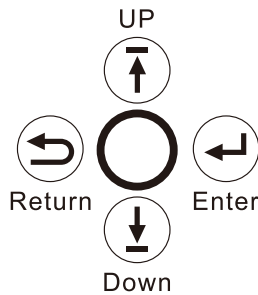

Button	Function
ESC	Exit
ENTER	Confirm, Enter menu
UP	Previous step or Slide right
DOWN	Next step or Slide left

Note: Long-pressing the UP and DOWN keys will continuously input the corresponding key signals.

General Operations

Through button control, press ENTER on the home screen to access the menu options

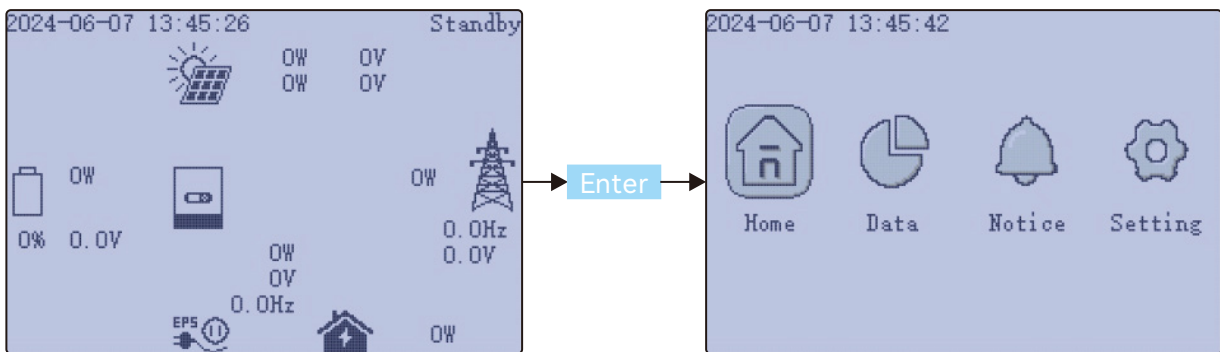

Using the UP and DOWN buttons, select the desired function, then press ENTER to enter. Press ESC to return to the previous level. The options include Home for the main page, Data for operational data, Notice for fault and warning information, and Setting for configuration settings.

Note: Click the Down button again, then jump to Notifications, Settings, Home, and complete a loop..

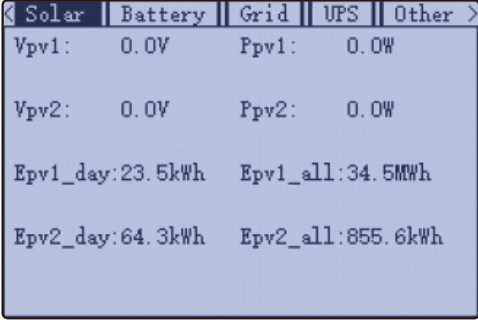
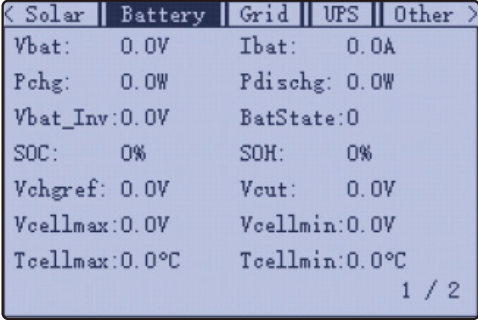
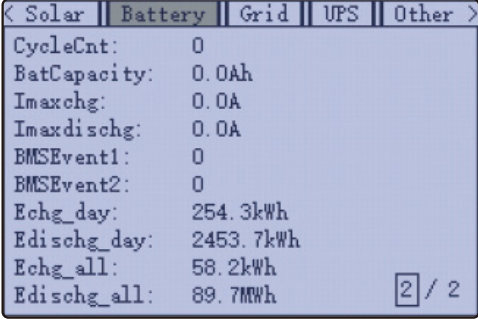
Index	Description	Data
1	Solar	 <p>The figure shows the voltage and power of Pv1, the voltage and power of PV2, the power generation of PV1 in one day and the total power generation of PV1, the power generation of PV2 in one day and the total power generation of Pv2.</p>
2	Battery (1)	 <p>The first page contains the following information: battery voltage, battery charge and discharge current, battery charge power, battery discharge power, inverter sampling battery voltage, battery status, battery remaining power, battery health, battery charge cut-off voltage, battery discharge cut-off voltage. The highest cell voltage. Lowest cell voltage. Highest cell temperature, lowest cell temperature.</p>
3	Battery (2)	 <p>The second page contains the following information: the number of charge and discharge times of the battery, the capacity of the battery, the maximum charge current, the maximum discharge current, BMS event 1, BMS event 2, the charge power in a day, the discharge power in a day, the total charge power, the total discharge power.</p>

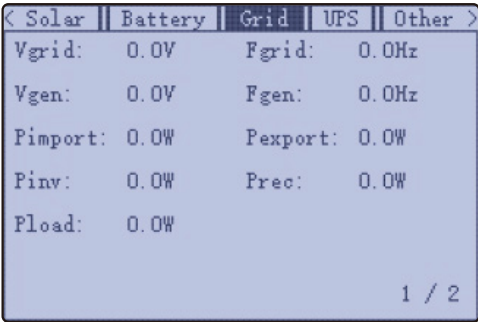
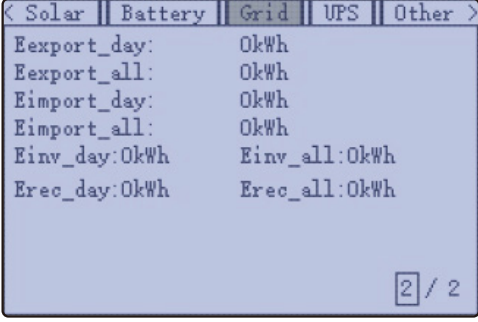
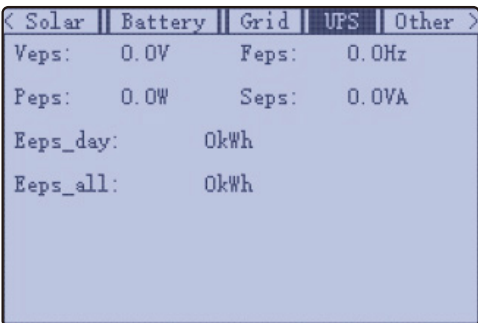
<p>4</p>	<p>Grid (1)</p>	 <pre> < Solar Battery Grid UPS Other > Vgrid: 0.0V Fgrid: 0.0Hz Vgen: 0.0V Fgen: 0.0Hz Pimport: 0.0W Pexport: 0.0W Pinv: 0.0W Prec: 0.0W Pload: 0.0W 1 / 2 </pre> <p>The first page contains the following information: grid voltage, grid frequency, generator voltage, generator frequency, power input from the grid to the inverter, power output from the inverter to the grid, inverter power, rectified power, load power.</p>
<p>5</p>	<p>Grid (2)</p>	 <pre> < Solar Battery Grid UPS Other > Eexport_day: 0kWh Eexport_all: 0kWh Eimport_day: 0kWh Eimport_all: 0kWh Einv_day:0kWh Einv_all:0kWh Erec_day:0kWh Erec_all:0kWh 2 / 2 </pre> <p>The second page contains the following information: The power of the inverter exported to the grid during the day. The total power of the inverter exported to the grid. The power that the grid imports into the inverter during the day. The total power imported from the grid to the inverter. The power output of the inverter during the day. The power of inverter rectification in a day.</p>
<p>6</p>	<p>UPS (1)</p>	 <pre> < Solar Battery Grid UPS Other > Veps: 0.0V Feps: 0.0Hz Peps: 0.0W Seps: 0.0VA Eeps_day: 0kWh Eeps_all: 0kWh </pre> <p>The first page contains the following information: load voltage, load frequency. Active power of LOAD, apparent power of LOAD. LOAD Power output in a day. LOAD Indicates the total power output.</p>

<p>7</p>	<p>Parallel</p>	<div data-bbox="730 286 1206 600" data-label="Code-Block"> <pre> < Battery Grid UPS Parallel Oth > Parallel Role: Master Parallel Type: Single phase Parallel Phase: R phase Parallel Num: 0 Parallel Addr: 0 </pre> </div> <p data-bbox="555 629 1366 757">This page contains information about the role of the machine in the parallel state (host or slave). Parallel type (single phase or three phase). Parallel phase[®] or S or T). Number of parallel machines. Parallel address.</p>
<p>8</p>	<p>Other</p>	<div data-bbox="730 853 1206 1167" data-label="Code-Block"> <pre> < Solar Battery Grid UPS Other > Status: PVCharge NextStatus: Standby FaultCode: 0000 0000 AlarmCode: 0000 0000 Vbus1: 0.0V Vbus2: 0.0V VbusP: 0.0V VbusN: 0.0V T1: 0.0°C T2: 0.0°C ExitReason1: 0000 0000 ExitReason2: 0000 0000 Run_Trace: 0 </pre> </div> <p data-bbox="555 1189 1366 1384">This page contains text information about the current status of the inverter. Inverter error code. Inverter alarm code. Voltage of BUS1. Voltage of BUS2. Positive BUS voltage. Negative voltage of the BUS. The temperature of T1 is the temperature of the I/O board (the highest value). T2 is the temperature of the motherboard (take the highest value).</p>

Index	Description	Notice
1	Fault Status	<div data-bbox="730 331 1209 654" data-label="Image"> <p>The screenshot shows a navigation bar with 'Fault Status', 'Alarm Status', and 'Record'. Below the bar is a large circular icon containing a checkmark, with the text 'NO Fault' centered underneath.</p> </div> <p>Information on this page: When the inverter fails, this page displays the corresponding fault code. If there is NO Fault, no fault is displayed.</p>
2	Alarm Status	<div data-bbox="730 880 1209 1202" data-label="Image"> <p>The screenshot shows a navigation bar with 'Fault Status', 'Alarm Status', and 'Record'. Below the bar is a large circular icon containing a checkmark, with the text 'NO Alarm' centered underneath.</p> </div> <p>Information contained in this page: When the inverter alarm appears, this page will display the corresponding alarm code. If there is NO Alarm, no alarm is displayed.</p>
3	Record	<div data-bbox="730 1480 1209 1803" data-label="Image"> <p>The screenshot shows a navigation bar with 'Fault Status', 'Alarm Status', and 'Record'. Below the bar, the text reads: 'Error Record: ⊗', followed by a list of five entries: '01. 2020-11-01 10:20:30 FaultCode8', '02. 2021-01-06 02:18:12 ParaCANFault', '03. 2000-00-00 00:00:00 ComLossCtrl', '04. 2000-00-00 00:00:00 ComLossCtrl', and '05. 2000-00-00 00:00:00 ComLossCtrl'. At the bottom right, it shows '1 / 8'.</p> </div> <p>This page contains information that lists the history of failures and alarms. Specific to the time and date of failure or alarm. The fault history is displayed on pages 1 to 4. Pages five through eight show the history of the call.</p>

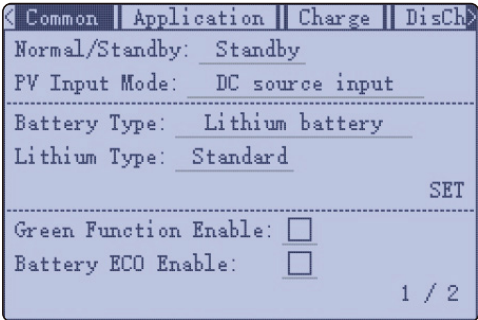
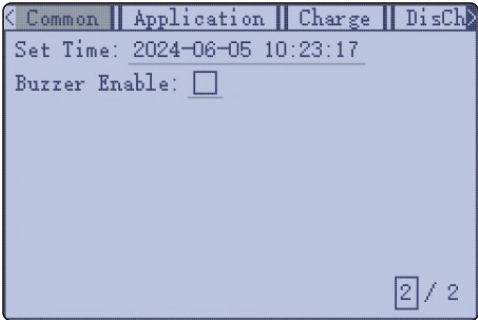
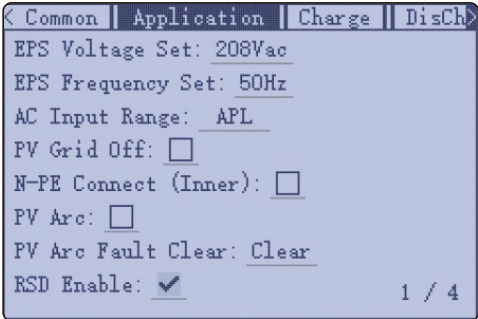
Index	Description	Setting																								
1	Common	<div style="display: flex; justify-content: space-between; align-items: flex-start;"> <table border="1" style="font-size: 8px; margin-bottom: 10px;"> <caption>Battery brand</caption> <tr><td>Standard</td><td>Lux</td></tr> <tr><td>HinaESS</td><td>Aobo</td></tr> <tr><td>Pylon</td><td>Dyness</td></tr> <tr><td>Enopte</td><td>Stealth</td></tr> <tr><td>MSUN</td><td>TeLongMei</td></tr> <tr><td>GSL1</td><td>Merit</td></tr> </table>  <table border="1" style="font-size: 8px; margin-bottom: 10px;"> <caption>Battery brand</caption> <tr><td>BYD</td><td>GW</td></tr> <tr><td>SHINWA</td><td>Beta</td></tr> <tr><td>WeCo</td><td>Revov</td></tr> <tr><td>Murata</td><td>Beebeej</td></tr> <tr><td>BITek</td><td>Naxin</td></tr> <tr><td>OKSolar</td><td>Soltaro</td></tr> </table> <p>The first page contains the following information: inverter status information (rated or standby). PV input mode (DC source or PV1 and PV2 independent or PV1 and PV2 parallel). Type of battery (lithium or lead-acid or no battery). Lithium battery brands (containing 24 battery brands). Green energy saving enabled. Battery energy saving is enabled.</p> </div> <div style="margin-top: 20px;">  <p>The second page contains the following information: The Settings of the year, month and date. Enabling the buzzer.</p> </div>	Standard	Lux	HinaESS	Aobo	Pylon	Dyness	Enopte	Stealth	MSUN	TeLongMei	GSL1	Merit	BYD	GW	SHINWA	Beta	WeCo	Revov	Murata	Beebeej	BITek	Naxin	OKSolar	Soltaro
Standard	Lux																									
HinaESS	Aobo																									
Pylon	Dyness																									
Enopte	Stealth																									
MSUN	TeLongMei																									
GSL1	Merit																									
BYD	GW																									
SHINWA	Beta																									
WeCo	Revov																									
Murata	Beebeej																									
BITek	Naxin																									
OKSolar	Soltaro																									
2	Application (1)	 <p>The first page contains information on LOAD output voltage Settings (240, 230, 220, 208, 200). LOAD output frequency setting (50HZ or 60HZ). AC input range (UPS: 170-280 or APL: 90-280). The PV off-network function was enabled. N-PE is enabled. AFCI enabled, AFCI clear, RSD enabled.</p>																								

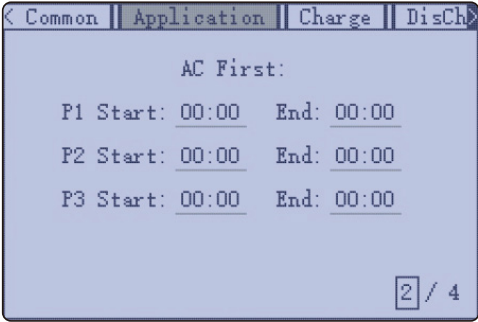
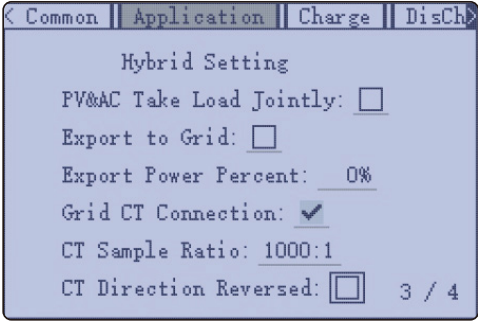
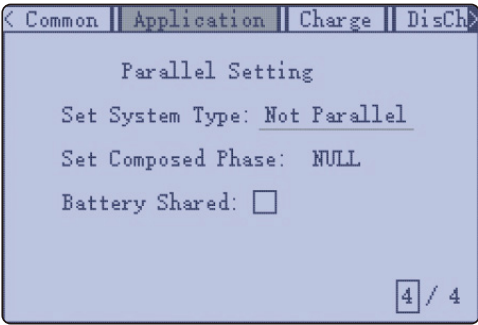
<p>3</p>	<p>Application (2)</p>	 <p>The second page contains information: AC priority charging time, you can set three time periods.</p>
<p>4</p>	<p>Application (3)</p>	 <p>The third page contains the following information: Mixed mode Settings. PV and AC are loaded together. empowerExport to the grid. Percentage of electricity output to the grid.Enable the CT function on the inverter power grid side. The default CT ratio is 1000:1. It can also be set to 2000:1 and 3000:1.</p>
<p>5</p>	<p>Application (4)</p>	 <p>The fourth page contains information: Type of parallel machine (no parallel machine or single phase parallel machine or three phase parallel machine). Parallel phase (R, S, T) can be set. The battery sharing function was enabled.</p>

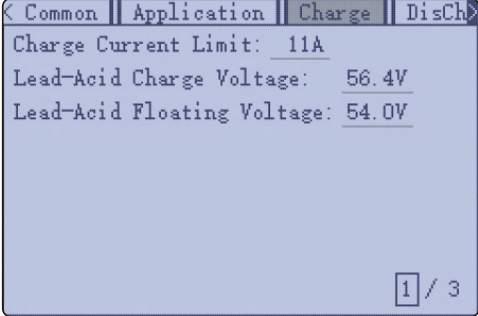
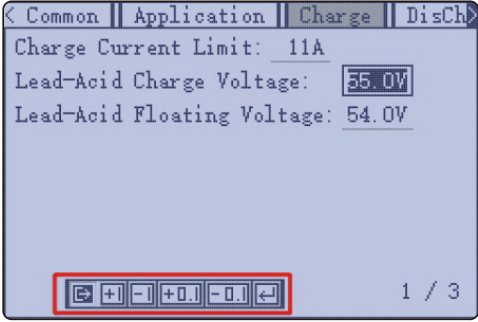
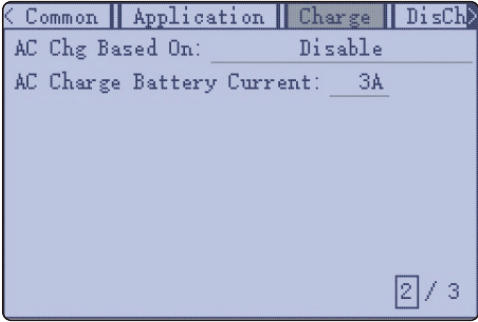
<p>6</p>	<p>Charge (1)</p>	 <p>The first page contains information: charging current Settings. CV voltage setting of lead-acid battery. Lead-acid battery floating charge voltage setting.</p>
<p>7</p>	<p>Charge (Numerical setting operation)</p>	 <p>This page contains: Setting values. After pressing Down, exit move to +1, +1 to -1, -1 to +0.1, +0.1 to -0.1, and -0.1 to Enter. Press UP to roll back. If you press Enter when the cursor moves to +1, 55 becomes 56. If you press Enter when the cursor moves to -1, 55 becomes 54. If you press Enter when the cursor moves to -0.1, 55 becomes 54.9. If you press Enter when the cursor moves to +0.1, 55 becomes 55.1.</p>
<p>8</p>	<p>Charge (2)</p>	 <p>The second page contains information: AC charging mode enable Settings. AC charging current setting.</p>

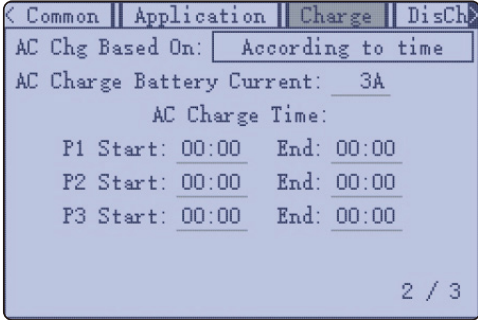
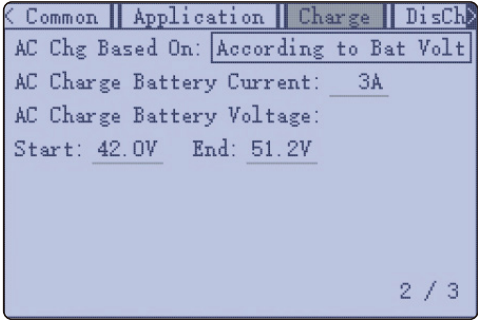
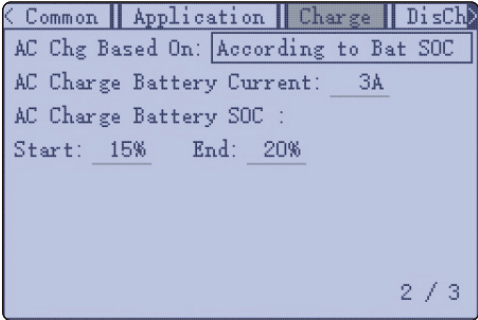
<p>9</p>	<p>Charge (according to the time)</p>	 <p>The second page contains information: The AC is charged according to the time, and three time periods are provided.</p>
<p>10</p>	<p>Charge (according to the battery voltage)</p>	 <p>The second page contains information: The AC is charged according to the battery voltage. The starting charge voltage and cut-off charge voltage can be set.</p>
<p>11</p>	<p>Charge (according to the battery SOC)</p>	 <p>The second page contains information: The AC is charged according to the battery SOC. Start charge SOC and stop charge SOC can be set.</p>

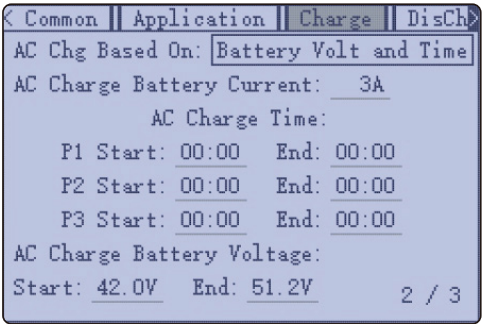
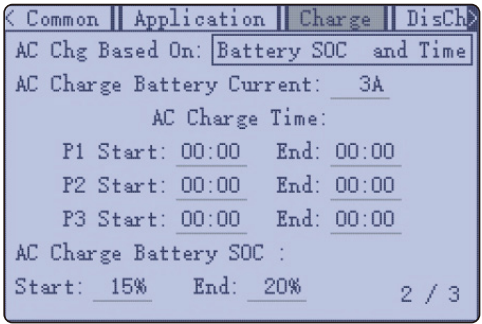
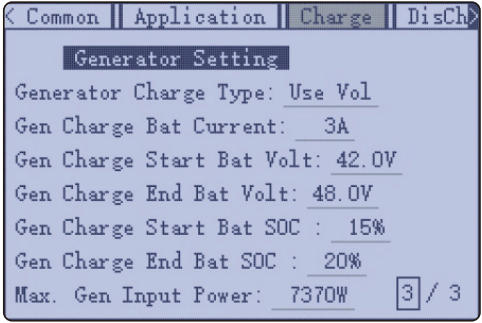
<p>12</p>	<p>Charge (according to the battery voltage and time)</p>	 <p>The second page contains information: The AC is charged according to the battery voltage and time. Meet one of the three time periods and the battery voltage between the starting charge voltage and the cut-off charge voltage. The AC will be charged.</p>
<p>13</p>	<p>Charge (according to time and SOC)</p>	 <p>The second page contains information: The AC is charged according to time and SOC. Meet one of the three time periods and the battery SOC between the start charge SOC and the cut-off charge SOC. The AC will be charged.</p>
<p>14</p>	<p>Charge (3)</p>	 <p>The third page contains information about the Settings for charging the generator. The generator is charged according to the battery voltage or battery SOC. Battery charging current can be set. The battery voltage can be set to start charging. You can set the battery voltage at the end of charging. Battery SOC can be set to start charging. Battery SOC can be set to end charging. The maximum input power of the generator can be set.</p>

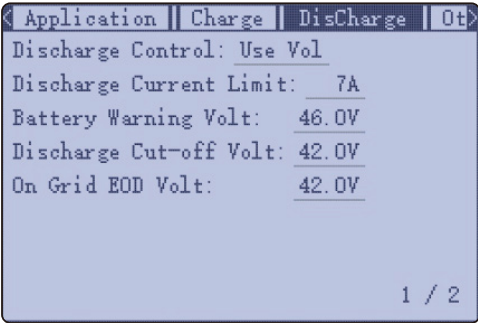
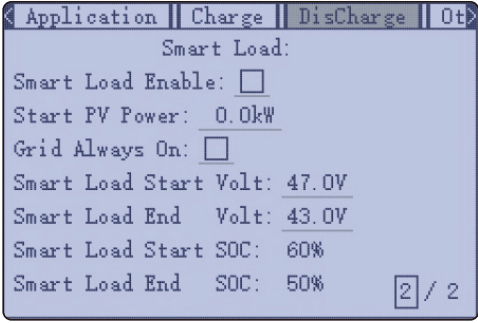
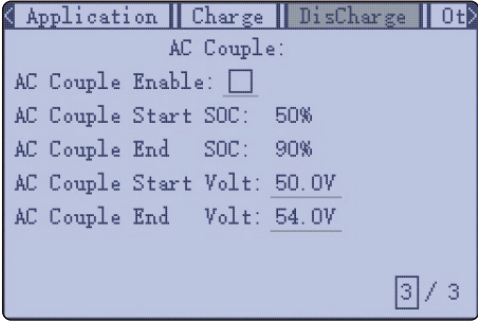
<p>15</p> <p>DisCharge (1)</p>		 <p>The first page contains information: battery discharge can be based on voltage or SOC. Discharge current can be set. Battery alarm voltage can be set. Off-grid discharge cutoff voltage can be set. Grid-connected discharge cutoff voltage can be set. The alarm voltage is larger than the off-grid cut-off voltage. The off-grid cut-off voltage range is complementary to the grid-connected cut-off voltage range.</p>
<p>16</p> <p>DisCharge (2)</p>		 <p>The second page contains the following information: Enable Smart Load. When the actual PV input power is greater than the value, the Smart Load function takes effect. Normally open when connected to the grid. Smart Load takes effect voltage point. Smart Load End voltage point. Smart Load takes effect on the SOC. Smart Load Ends the SOC.</p>
<p>17</p> <p>DisCharge (3)</p>		 <p>Page 3 contains the following information: Enable the AC Couple function. Enable the start SOC of the AC Couple. End The cutoff SOC of the AC Couple. Turn on the start voltage of the AC Couple. End The cut-off voltage of the AC Couple.</p>

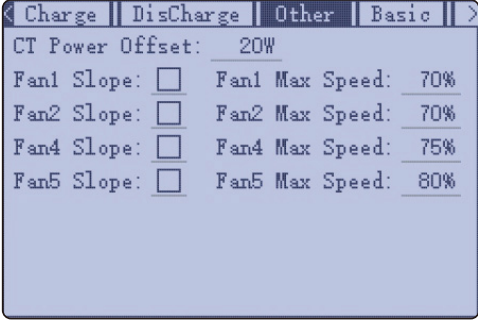
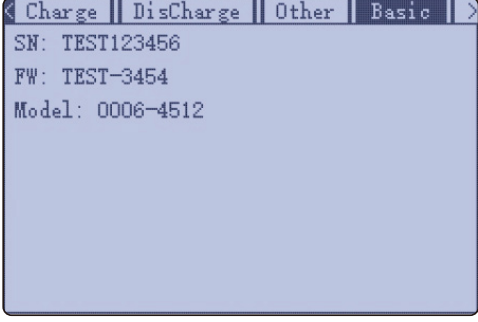
<p>18</p>	<p>Other</p>	 <p>Include information: CT power compensation setting. Set the maximum speed of five fans. Set five fan control slope curves.</p>
<p>19</p>	<p>Basic</p>	 <p>Contains information: SN Indicates the serial number of the inverter. FW Indicates the firmware version of the inverter (cEaa indicates the US version, cFaa indicates the European version).</p>

5. About LCD Settings check the operation

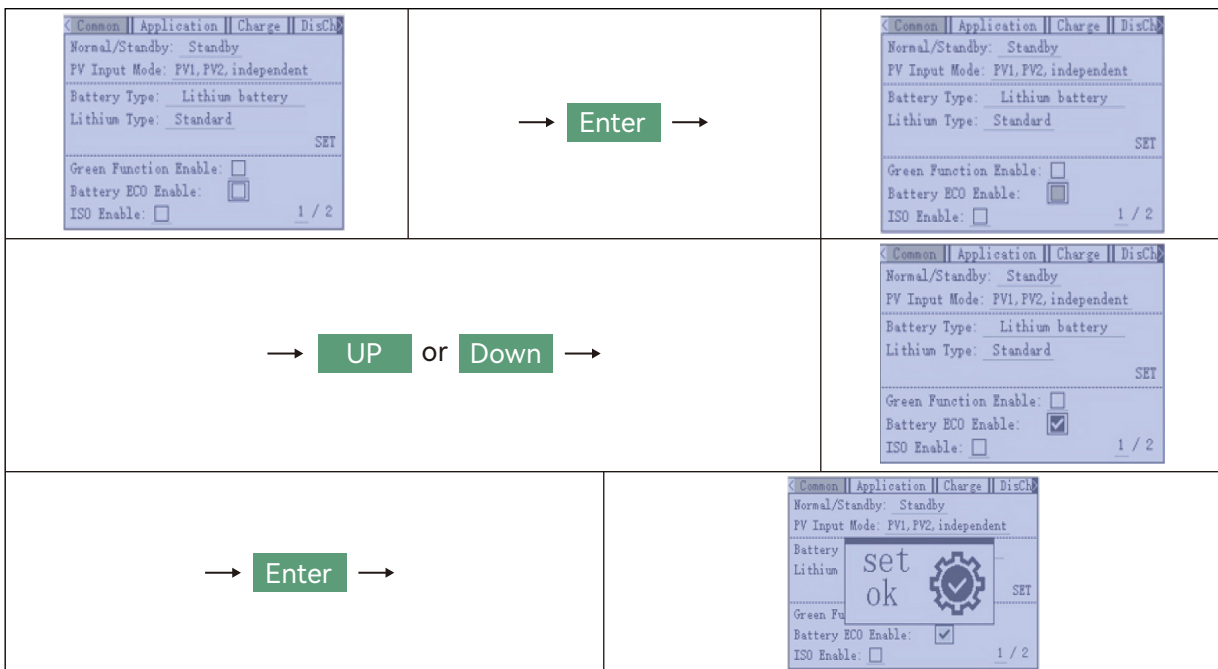

6. Monitor System for ECO Hybrid inverter

- Users can use wifi dongle/WLAN dongle/4G dongle (Avaiblable from 2021 March for some countries) to monitor the energy storage system, The monitor website is: server.luxpowertek.com.
- The APP is also available in the google play and apple APP store (Scan two code bar to download the APP).
- Please download the introduction of guidance by website: <https://www.luxpowertek.com/download/Document Reference>.

1. Wifi Quick Guidance

Quick guidance for setting password for wifi module, the paper is also available in the wifi box.

2. Monitor system setup for Distributors and **Monitor system setup for endusers**, Monitor system registration, wifi password setting, and wifi local monitor and setting.

3. Lux_Monitor_UI_Introduction

Introduction of monitor interface

4. Website Setting Guidance

Introduction of website settings for offgrid inverter

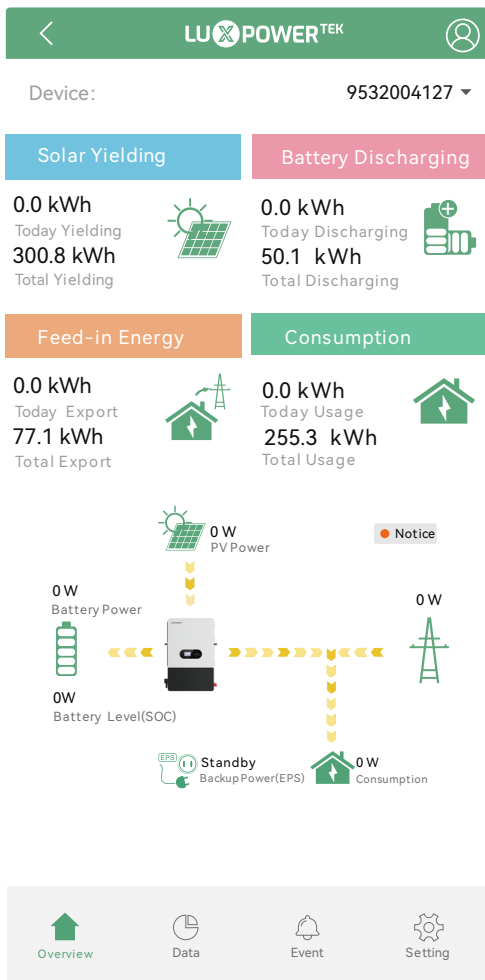

7. Specifications

Table 1 MPPT Mode Specifications	
INVERTER MODEL	SNA-EU 12000
Max. PV Array Power (W)	24000W (12000/12000)
Rated PV Input Voltage (V)	320
Number of Independent MPPT Inputs	2
Number of string per MPPT	2
PV Input Voltage Range (V)	100~480
MPPT Voltage Range (V)	120~385
Start-up Voltage (V)	100
Max. PV Input Current per MPPT (A)	35/35
Max. PV Short-circuit Current per MPPT (A)	44/44
Max. PV Charging Current for Battery	250A
Table 2 Battery Mode Specifications	
INVERTER MODEL	SNA-EU 12000
Output Voltage Waveform	Pure Sine Wave
Output Voltage Regulation	208Vac/220Vac/230Vac/240Vac±5%
Output Frequency	50/60Hz
Rated Output Power (W)	12000
Rated Output Current (A)	52
Max. Charging/Discharging Current (A)	250
Max. Charging/Discharging Power (W)	12000
Peak Efficiency	93%
Overload Protection	5s@≥150% load; 10s@110%~150% load
Surge Capacity	2* rated power within 5 seconds
Recommend Capacity of Battery per Inverter	>400AH
Battery Voltage Range	46.4V-60V (Li) 38.4V-60V (Lead_Acid)
High DC Cut-off Voltage	59VDC (Li) 60VDC (Lead_Acid)
High DC Recovery Voltage	57.4VDC (Li) 58VDC (Lead_Acid)

Low DC Warning Voltage (Lead Acid)	load < 20%	44.0Vdc (Settable)
	20% ≤ load < 50%	Warning Voltage@load < 20% - 1.2V
	load ≥ 50%	Warning Voltage@load < 20% - 3.6V
Low DC Warning Return Voltage(Lead Acid)		Low DC Warning Voltage@Different load+2V
Low DC Cut-off Voltage (Lead Acid)	load < 20%	42.0Vdc (Settable)
	20% ≤ load < 50%	Cut-off Voltage@load < 20% - 1.2V
	load ≥ 50%	Cut-off Voltage@load < 20% - 3.6V
Low DC Cut-off Return Voltage (Lead Acid)	Cut-off Voltage@load<20%≥45V	Low DC Cut-off Voltage@load<20%+3V
	Cut-off Voltage@load<20%<45V	48V
Low DC Warning SOC		20% SOC (Settable)
Low DC Warning Return SOC		Low DC Warning SOC +10%
Low DC Cut-off SOC		15% SOC (Grid on) (settable)
		15% SOC (Grid off) (settable)
Low DC Cut-off Return SOC		Low DC Cut-off SOC +10%
Charge Cut-off Voltage		58.4Vdc
No Load Power Consumption		<60W
Lead_Acid Battery Charging Algorithm		3-Step
Bulk Charging Voltage		Flooded Battery 58.4Vdc
		AGM/Gel Battery 56.4Vdc
Floating Charging Voltage		54Vdc

Charging Curve

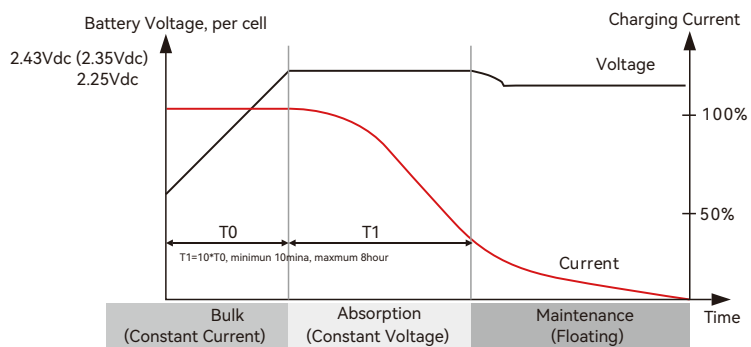

Table 3 Line Mode Specifications	
INVERTER MODEL	SNA-EU 12000
Input Voltage Wavefor	Sinusoidal (utility or generator)
Nominal Input Voltage (V)	230Vac
Low Loss Voltage	170Vac±7V (UPS); 90Vac±7V (Appliances)
Low Loss Return Voltage	180Vac±7V (UPS); 100Vac±7V (Appliances)
High Loss Voltage	280Vac±7V
High Loss Return Voltage	270Vac±7V
Max. AC Input Voltage	280Vac
Nominal Input Frequency	50Hz/60Hz (Auto detection)
Max. AC Input Current (A)	100
Max. AC Input Power (W)	24000
Max. AC Charging Current (A)	250
Rated AC Output Current (A)	52
Rated AC Output Power (W)	12000
Rated AC Current of Bypass Relays (A)	200
Output Short Circuit Protection	Software Protect when GridOff Discharge Circuit Breaker Protect when GridOn Bypass
Transfer Time	<10ms@Single ; <20ms@Parallel
Output power derating: When AC input voltage drops to 200V, the output power will be derated.	Max inv current: 60A Max inv power: 12kW
Smart Load Outputs the load and current	

Table 4 Generator Mode Specifications	
INVERTER MODEL	SNA-EU 12000
Rated GEN Voltage (V)	230
Rated GEN Frequency (Hz)	50/60
Rated GEN Input Current (A)	65
Rated GEN Input Power (W)	15000
Rated GEN Current of Bypass Relays (A)	90
Table 5 Protection/General Specifications	
INVERTER MODEL	SNA-EU 12000
Over Current/Voltage Protection	YES
Grid Monitoring	YES
AC Surge Protection Type III	YES
Safety Certification	NRS 097, CE
Ingress Protection Rating	IP 20
Display&Communication Interface	RGB+LED, RS485/WIFI/CAN
Warranty	2 Years
Cooling Method	FAN
Topology	Transformer-less
Noise Emission (typical)	<50dB
Operating Temperature Range	0°C to 45°C (full load)
Storage temperature	-15°C ~ 60°C
Humidity	5% to 95% Relative Humidity (Non-condensing)
Altitude	<2000m
Dimension (D*W*H)mm	830*530*150mm (25.59*17.72*5.9inch)
Net Weight	40kg

8. Trouble Shooting & Error List

The failures mainly divided into 5 categories, for each category, the behavior is different:

Code	Description	Trouble shooting
E000	Internal communication fault1	Restart inverter, if the error still exist, contact us (DSP&M3)
E001	Model fault	Restart inverter, if the error still exist, contact us
E003	CT Fail	Restart inverter, if the error still exist, contact us
E008	CAN communication error in Parallel System	Check CAN cable connection is connected to the right COM port
E009	No master in parallel system	Check parallel setting for master/Slave part, there should be one master in the system
E012	Off-gird, short-circuit of the Load or Smart Load.	Check if the load is short circuit, try to turn off the load and restart inverter
E013	UPS reserve current	Restart inverter, if the error still exist, contact us
E015	Phase Error in three phase parallel system	Check if the AC connection is right for three phase system, there should one at least one inverter in each phase
E018	Internal communication fault3	Restart inverter, if the error still exist, contact us (DSP&M3)
E019	Bus voltage high	Check if PV input voltage is higher than 495V
E020	AC connection fault	Check if LOAD and AC connection is in wrong terminal
E021	PV voltage high	Check PV input connection and if PV input voltage is higher than 480V
E022	Hardware Over current	Restart inverter, if the error still exist, contact us
E024	PV overcurrent	Check PV connection
E025	Temperature over range	The internal temperature of inverter is too high, turn off the inverter for 10minutes, restart the inverter, if the error still exist, contact us
E028	Sync signal lost in parallel system	Check CAN cable connection is connected to the right COM port
E029	Sync trigger signal lost in parallel system	Check CAN cable connection is connected to the right COM port

Code	Description	Trouble shooting
W000	Communication failure with battery	Check if you have choose the right battery brand and communication cable is right, if the warning still exist, contact us
W001	AFCI Com failure	Restart inverter, if the error persists, contact your supplier.
W002	AFCI High	Check each PV string for correct open circuit voltage and short circuit current. If the PV strings are in good condition, please clear the fault on inverter LCD.
W003	Communication failure with meter	Check communication cable, if the warning still exist, contact us
W004	Battery failure	Inverter get battery fault info from battery BMS, restart battery, if the warning still exist, contact us or battery manufacture
W006	RSD Active	Check if the RSD switch is pressed.
W008	Software mismatch	Please contact Luxpower for firmware update
W009	Fan Stuck	Check if the fan is OK
W013	Over temperature	The temperature is a little bit high inside inverter
W015	Bat Reverse	Check the battery connection with inverter is right, if the warning still exist, contact us
W017	AC Voltage out of range	Check AC voltage is in range
W018	AC Frequency out of range	Check AC frequency is in range
W019	AC inconsistent in parallel system	Reconnect the AC input or Restart inverter, if the error still exist, contact us
W020	PV Isolation low	Restart inverter, if the error still exist, contact us
W022	DC injection high	Restart inverter, if the error still exist, contact us
W025	Battery voltage high	Check if battery voltage is in normal range
W026	Battery voltage low	Check if battery voltage is in normal range, need to charge the battery if battery voltage is low
W027	Battery open	Check if there is output from the battery and battery connection with inverter is OK
W028	Over load	Check if load is too high
W029	The load output voltage is high	Restart inverter, if the error still exist, contact us
W031	Load DCV high	Restart inverter, if the error still exist, contact us

■ YOUR RELIABLE ENERGY SOLUTIONS PARTNER



Lux Power Technology Co., Ltd
Headquarter: +86 755 8520 9056
www.luxpowertek.com
Contact us: info@luxpowertek.com



092.20044AA