



User Manual

SP24 INFINISOALR V II WP **2/3/5KW** **SOLAR INVERTER / CHARGER**



Table Of Contents

ABOUT THIS MANUAL	1
Purpose.....	1
Scope.....	1
SAFETY INSTRUCTIONS.....	1
INTRODUCTION	2
Product Overview.....	3
INSTALLATION	4
Unpacking and Inspection	4
Preparation	4
Mounting the Unit.....	4
Battery Connection	5
AC Input/Output Connection.....	7
PV Connection	8
Communication Connection.....	10
BMS Communication	10
Dry Contact Signal.....	11
OPERATION	12
Power ON/OFF	12
Operation and Display Panel	12
LCD Display Icons	13
LCD Setting.....	14
Display Setting	22
Operating Mode Description	25
SPECIFICATIONS	29
TROUBLE SHOOTING.....	30
Appendix I: Parallel function.....	31
Appendix II: BMS Communication Installation	45
Appendix III: Approximate Back-up Time Table.....	47

ABOUT THIS MANUAL

Purpose

This manual describes the assembly, installation, operation and troubleshooting of this unit. Please read this manual carefully before installations and operations. Keep this manual for future reference.

Scope

This manual provides safety and installation guidelines as well as information on tools and wiring.

SAFETY INSTRUCTIONS



WARNING: This chapter contains important safety and operating instructions. Read and keep this manual for future reference.

1. Before using the unit, read all instructions and cautionary markings on the unit, the batteries and all appropriate sections of this manual.
2. **CAUTION** --To reduce risk of injury, charge only deep-cycle lead acid type rechargeable batteries. Other types of batteries may burst, causing personal injury and damage.
3. Do not disassemble the unit. Take it to a qualified service center when service or repair is required. Incorrect re-assembly may result in a risk of electric shock or fire.
4. To reduce risk of electric shock, disconnect all wirings before attempting any maintenance or cleaning. Turning off the unit will not reduce this risk.
5. **CAUTION** – Only qualified personnel can install this device with battery.
6. **NEVER** charge a frozen battery.
7. For optimum operation of this inverter/charger, please follow required spec to select appropriate cable size. It's very important to correctly operate this inverter/charger.
8. Be very cautious when working with metal tools on or around batteries. A potential risk exists to drop a tool to spark or short circuit batteries or other electrical parts and could cause an explosion.
9. Please strictly follow installation procedure when you want to disconnect AC or DC terminals. Please refer to INSTALLATION section of this manual for the details.
10. Fuses are provided as over-current protection for the battery supply.
11. GROUNDING INSTRUCTIONS -This inverter/charger should be connected to a permanent grounded wiring system. Be sure to comply with local requirements and regulation to install this inverter.
12. NEVER cause AC output and DC input short circuited. Do NOT connect to the mains when DC input short circuits.
13. **Warning!!** Only qualified service persons are able to service this device. If errors still persist after following troubleshooting table, please send this inverter/charger back to local dealer or service center for maintenance.
14. **WARNING!! ATTENTION IN CASE OF MALFUNCTION OF THE PRODUCT PLEASE CONTACT US BY EMAIL AT assistenza@solarpower24.it WITH THE SERIAL NUMBER OF PRODUCT, EXACT MODEL, DEFECT FOUND AND YOU WILL BE CONTACTED. PLEASE NOTE THAT THE PRODUCT MUST NOT BE OPENED IN ANY WAY AND THAT OPENING WITH THE CONSEQUENT BREAKING OF THE WARRANTY SEAL VOIDS WARRANTY ON THE PRODUCT.**

INTRODUCTION

This hybrid PV inverter can provide power to connected loads by utilizing PV power, utility power and battery power.

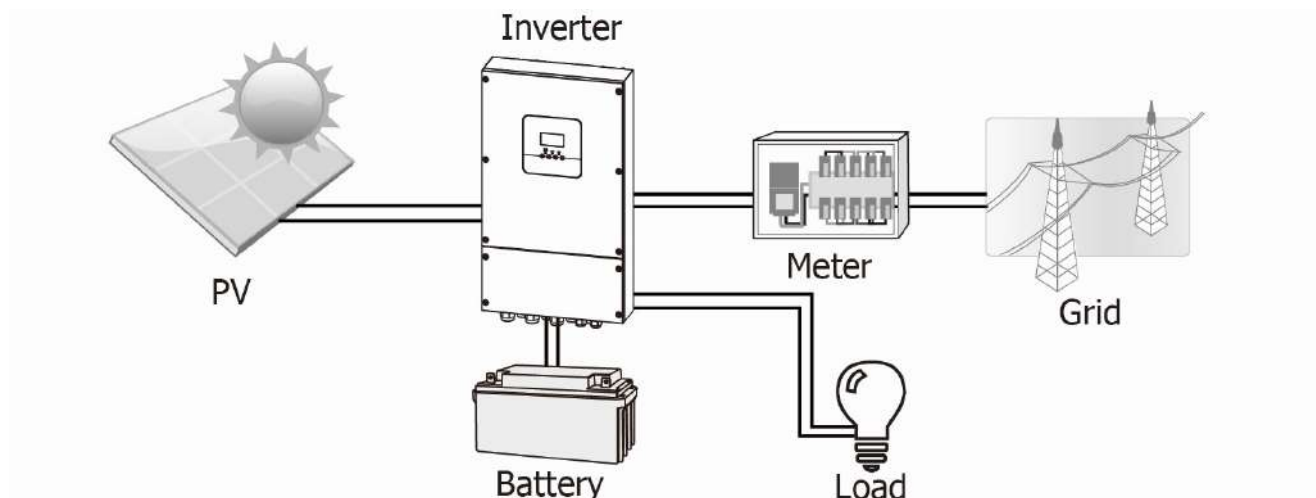
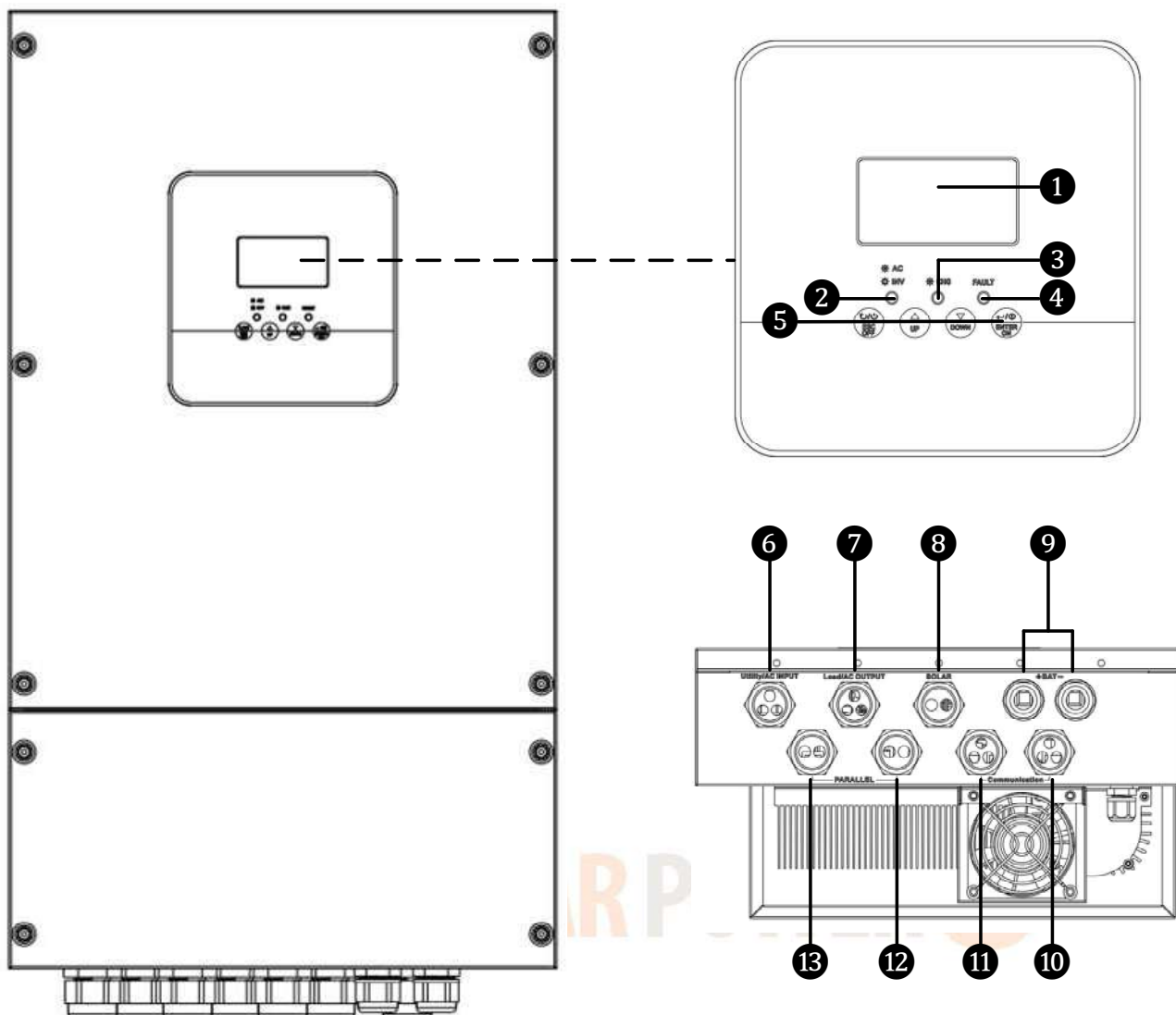

Figure 1 Basic hybrid PV System Overview

Depending on different power situations, this hybrid inverter is designed to generate continuous power from PV solar modules (solar panels), battery, and the utility. When MPP input voltage of PV modules is within acceptable range (see specification for the details), this inverter is able to generate power to feed the grid (utility) and charge battery. **Never connect the positive and negative terminals of the solar panel to the ground.** See Figure 1 for a simple diagram of a typical solar system with this hybrid inverter.

Product Overview



NOTE: For parallel model installation and operation, please check separate parallel installation guide for the details.

1. LCD display
2. Status indicator
3. Charging indicator
4. Fault indicator
5. Function buttons
6. Grid connectors
7. AC output connectors (Load connection)
8. PV connectors
9. Battery connectors
10. BMS & RS-485 communication ports
11. Dry contact & USB & RS-232 communication ports
12. Current sharing ports
13. Parallel communication ports

INSTALLATION

Unpacking and Inspection

Before installation, please inspect the unit. Be sure that nothing inside the package is damaged. You should have received the following items inside of package:

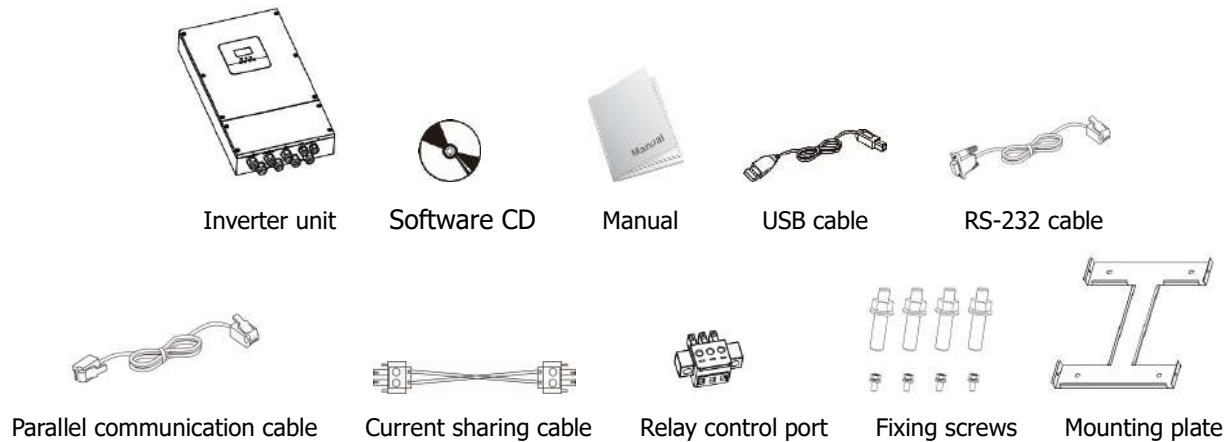

Preparation

Before connecting all wirings, please take off bottom cover by removing four screws as shown below.

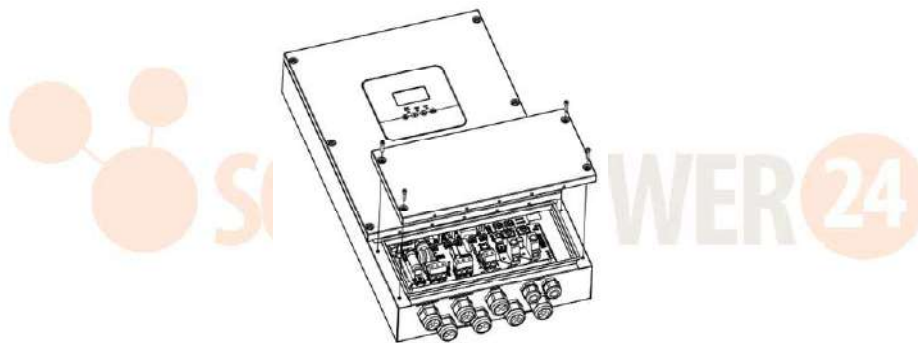

Mounting the Unit

Consider the following points before selecting where to install:

- Do not mount the inverter on flammable construction materials.
- Mount on a solid surface
- Install this inverter at eye level in order to allow the LCD display to be read at all times.
- The ambient temperature should be between 0°C and 55°C to ensure optimal operation.
- The recommended installation position is to be adhered to the wall vertically.
- Be sure to keep other objects and surfaces as shown in the right diagram to guarantee sufficient heat dissipation and to have enough space for removing wires.



SUITABLE FOR MOUNTING ON CONCRETE OR OTHER NON-COMBUSTIBLE SURFACE ONLY.

WARNING!! Remember that this inverter is heavy! Please be careful when lifting out from the package.

WARNING!! FIRE HAZARD.

SUITABLE FOR MOUNTING ON CONCRETE OR OTHER NON-COMBUSTIBLE SURFACE ONLY.

Be sure to keep other objects away and leave the space to a minimum as shown in the right diagram to guarantee sufficient heat dissipation and enough space for replacing wires.

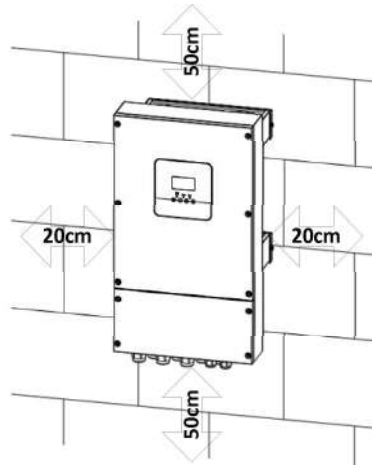

Installation to the wall should be implemented with the proper screws. After that, the device should be bolted on securely.

The inverter only can be used in a CLOSED ELECTRICAL OPERATING AREA. Only serviceperson can enter this area.

1. Drill four holes in the marked locations with the supplied four screws. The reference tightening torque is 35 N.m.

2. Raise the inverter and place it over the mounting plate.

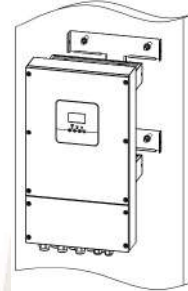
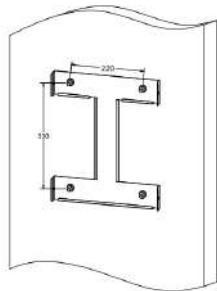

3. Fix the inverter in position by screwing the supplied four screws (M5*4) located on the top two sides of the inverter.

4. Check if the inverter is firmly secured.

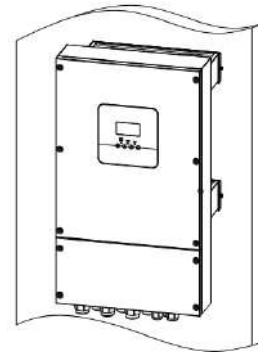
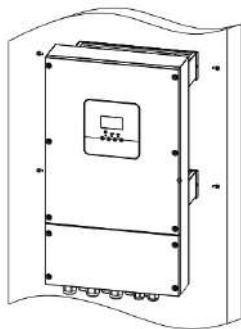

Battery Connection

CAUTION: For safety operation and regulation compliance, it's requested to install a separate DC over-current protector or disconnect device between battery and inverter. It may not be requested to have a disconnect device in some applications, however, it's still requested to have over-current protection installed. Please refer to typical amperage in below table as required fuse or breaker size.

WARNING! All wiring must be performed by a qualified personnel.

WARNING! It's very important for system safety and efficient operation to use appropriate cable for battery connection. To reduce risk of injury, please use the

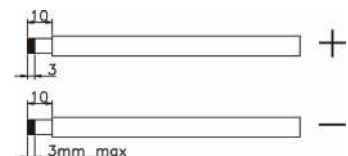

proper recommended cable and terminal size as below.

Recommended battery cable and terminal size:

Model	Typical Amperage	Battery Capacity	Wire Size	Torque Value
2KW	55A	100AH	1*4AWG	2~3 Nm
3KW	82A	200AH	1*4AWG	2~3 Nm
5KW	137A	200AH	1*2AWG	2~3 Nm

Please follow the below steps to implement battery connection:

1. Remove insulation sleeve 7mm for two conductors.
2. Insert battery wires according to polarities indicated on the terminal block and tighten the terminal screws. Make sure polarity at both the battery and the inverter/charge is correctly connected.

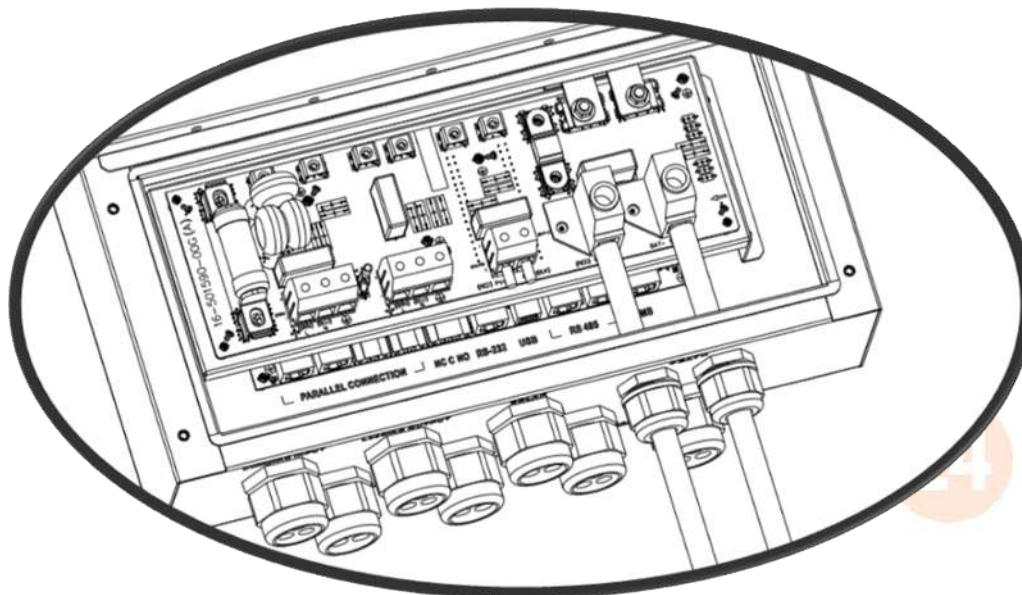

 **WARNING: Shock Hazard**
Installation must be performed with care due to high battery voltage in series.

 **CAUTION!!** Do not place anything between the flat part of the inverter terminal and the ring terminal. Otherwise, overheating may occur.
CAUTION!! Do not apply anti-oxidant substance on the terminals before terminals are connected tightly.
CAUTION!! Before making the final DC connection or closing DC breaker/disconnector, be sure positive (+) must be connected to positive (+) and negative (-) must be connected to negative (-).

AC Input/Output Connection

CAUTION!! Before connecting to AC input power source, please install a **separate** AC breaker between inverter and AC input power source. This will ensure the inverter can be securely disconnected during maintenance and fully protected from over current of AC input.

CAUTION!! There are two terminal blocks with "IN" and "OUT" markings. Please do NOT mis-connect input and output connectors.

WARNING! All wiring must be performed by a qualified personnel.

WARNING! It's very important for system safety and efficient operation to use appropriate cable for AC input connection. To reduce risk of injury, please use the proper recommended cable size as below.

Suggested cable requirement for AC wires

Model	Gauge	Torque Value
2KW	10 AWG	0.8~ 1.0 Nm
3KW	10 AWG	1.2~ 1.6 Nm
5KW	10 AWG	1.2~ 1.6 Nm

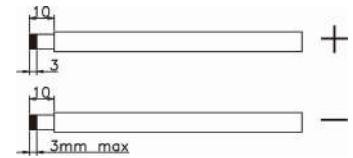

Please follow below steps to implement AC input/output connection:

1. Before making AC input/output connection, be sure to open DC protector or disconnecter first.
2. Remove insulation sleeve 7mm for six conductors.
3. Insert AC input wires according to polarities indicated on terminal block and tighten the terminal screws. Be sure to connect PE protective conductor (⊕) first.

⊕ → **Ground (yellow-green)**

L → **LINE (brown or black)**

N → **Neutral (blue)**

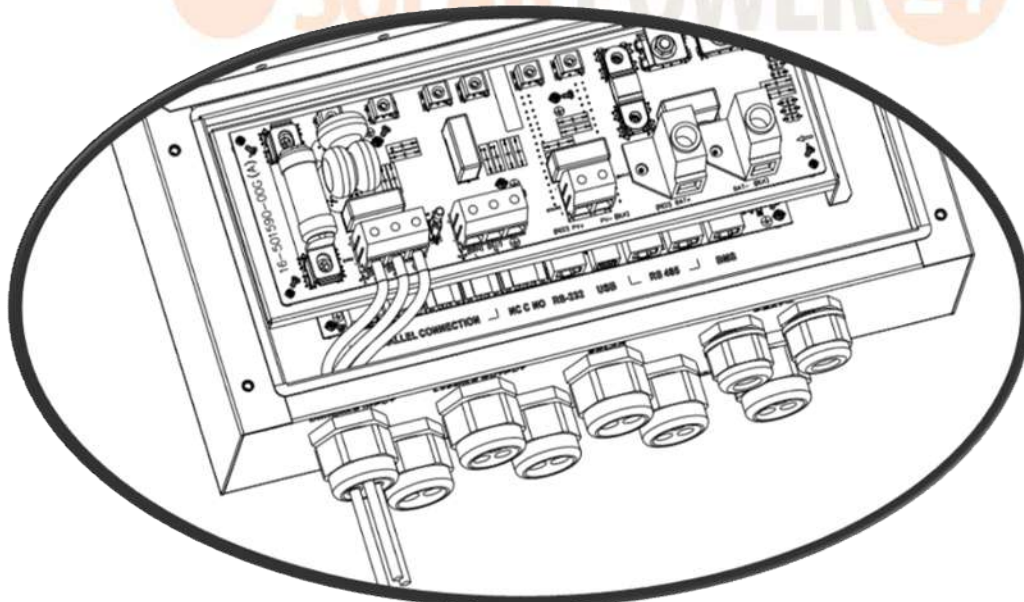

WARNING:

Be sure that AC power source is disconnected before attempting to hardwire it to the unit.

4. Then, insert AC output wires according to polarities indicated on terminal block and tighten terminal screws.
 Be sure to connect PE protective conductor (⊕) first.
 ⊕ → **Ground (yellow-green)**
L → **LINE (brown or black)**
N → **Neutral (blue)**

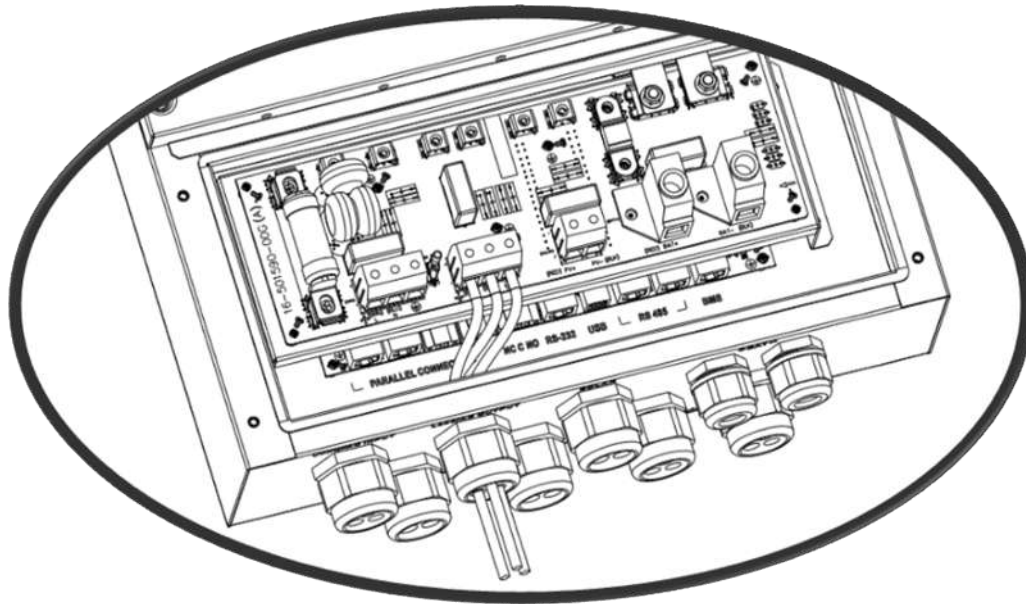

5. Make sure the wires are securely connected.

CAUTION: Important

Be sure to connect AC wires with correct polarity. If L and N wires are connected reversely, it may cause utility short-circuited when these inverters are worked in parallel operation.

CAUTION: Appliances such as air conditioner are required at least 2~3 minutes to restart because it's required to have enough time to balance refrigerant gas inside of circuits. If a power shortage occurs and recovers in a short time, it will cause damage to your connected appliances. To prevent this kind of damage, please check manufacturer of air conditioner if it's equipped with time-delay function before installation. Otherwise, this inverter/charger will trig overload fault and cut off output to protect your appliance but sometimes it still causes internal damage to the air conditioner.

PV Connection

CAUTION: Before connecting to PV modules, please install **separately** a DC circuit breaker between inverter and PV modules.

WARNING! All wiring must be performed by a qualified personnel.

WARNING: Please switch off the inverter before you connect PV modules. Otherwise, it will damage the inverter.

WARNING! It's very important for system safety and efficient operation to use appropriate cable for PV module connection. To reduce risk of injury, please use the proper recommended cable size as below.

Model	Typical Amperage	Cable Size	Torque
2KW	13A	12AWG	2.0~2.4Nm
3KW	18A	10AWG	2.0~2.4Nm
5KW	27A	8AWG	2.0~2.4Nm

PV Module Selection:

When selecting proper PV modules, please be sure to consider below parameters:

1. Open circuit Voltage (Voc) of PV modules not exceeds max. PV array open circuit voltage of inverter.
2. Open circuit Voltage (Voc) of PV modules should be higher than min. battery voltage.

Solar Charging Mode			
INVERTER MODEL	2KW	3KW	5KW
Max. PV Array Open Circuit Voltage	400 Vdc	500 Vdc	500 Vdc
PV Array MPPT Voltage Range	120~400Vdc	120~400Vdc	120~450Vdc
MPP Number	1		

Please follow below steps to implement PV module connection:

1. Remove insulation sleeve 7 mm for positive and negative conductors.
2. Check correct polarity of connection cable from PV modules and PV input connectors. Then, connect positive pole (+) of connection cable to positive pole (+) of PV input connector. Connect negative pole (-) of connection cable to negative pole (-) of PV input connector.

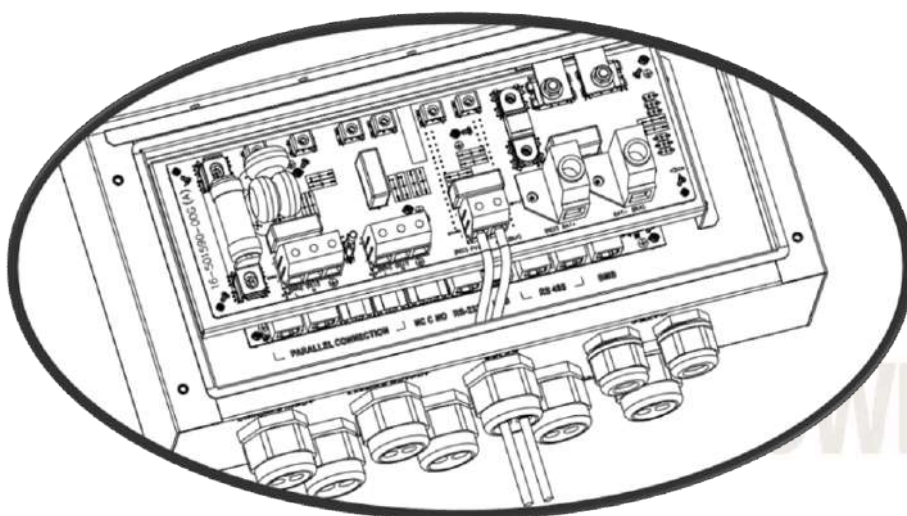
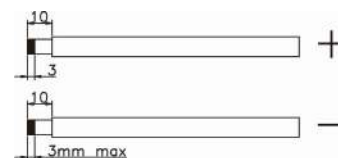

Recommended PV module Configuration

PV Module Spec. (reference)	Total solar input power	Solar input	Q'ty of modules
- 250Wp - Vmp: 30.7Vdc - Imp: 8.15A - Voc: 37.4Vdc - Isc: 8.63A - Cells: 60	1500W	6 pieces in series	6 pcs
	2000W	8 pieces in series	8 pcs
	2750W	11 pieces in series	11 pcs
	3000W	6 pieces in series 2 strings in parallel	12 pcs
	4000W	8 pieces in series 2 strings in parallel	16 pcs
	5000W	10 pieces in series 2 strings in parallel	20 pcs
	6000W	12 pieces in series 2 strings in parallel	24 pcs

Communication Connection

Please use the supplied communication cable to connect to the inverter and PC. Follow the below procedure to connect communication wiring. Insert bundled CD into a computer and follow the on-screen instructions to install the monitoring software. For the detailed software operation, please check the user manual of the software inside of a CD.

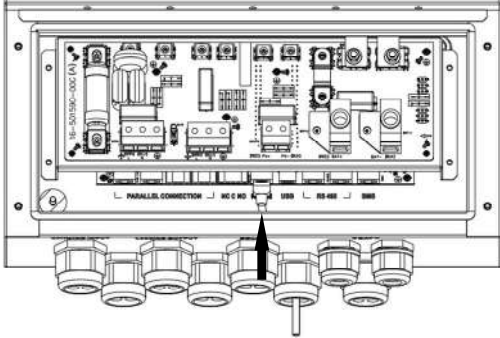
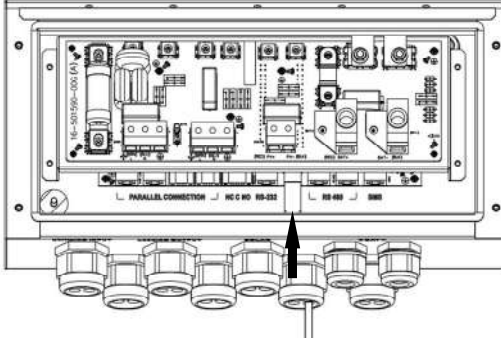
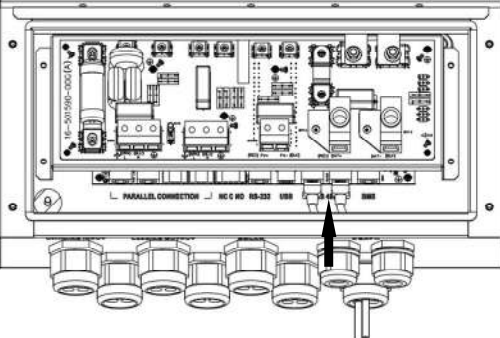
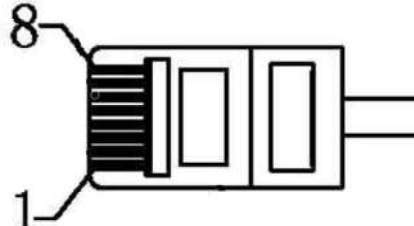
<p>For RS232 port, you should use a RJ45 cable as follows:</p>	<p>For USB port, you should use a USB cable as follows:</p>
<p>PIN1: TXD, PIN2:RXD, PIN4:12V, PIN8:GND</p>	
	
<p>For RS485 port, you should use a RJ45 cable as follows:</p>	<p>The RJ45 line sequence is as follows:</p>
<p>PIN4: RS485-A, PIN5: RS485-B, PIN8:GND</p>	
	

BMS Communication

For BMS port, you should use a RJ45 cable as follows:

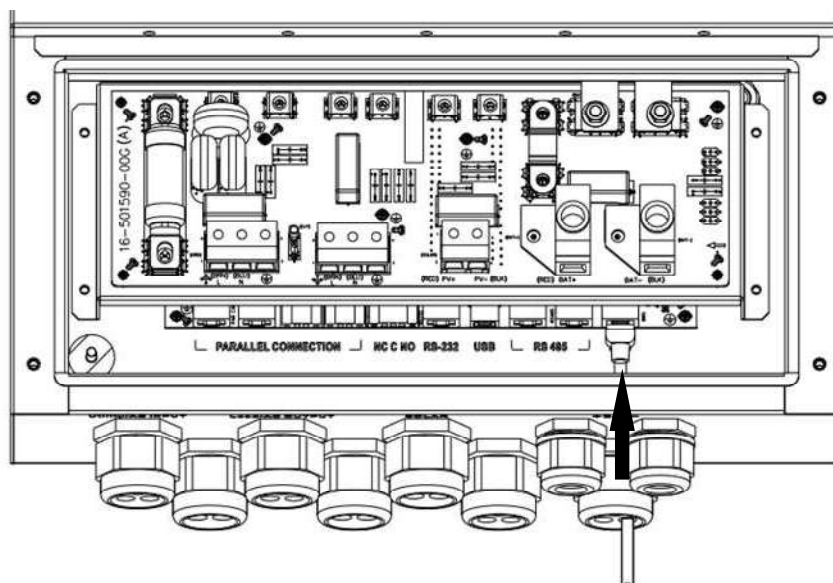

It is recommended to purchase a special communication cable if you are connecting to Lithium-ion battery banks. Please use a RJ45 cable to connect BMS communication port as shown in below:

PIN Assignment	
PIN 4	RS485-A
PIN 5	RS485-B
PIN 8	GND

For more information, please refer to Appendix II: BMS Communication Installation.

Dry Contact Signal

There is one dry contact (3A/250VAC) available on the rear panel. It could be used to deliver a signal to an external device when the battery voltage reaches the warning level.

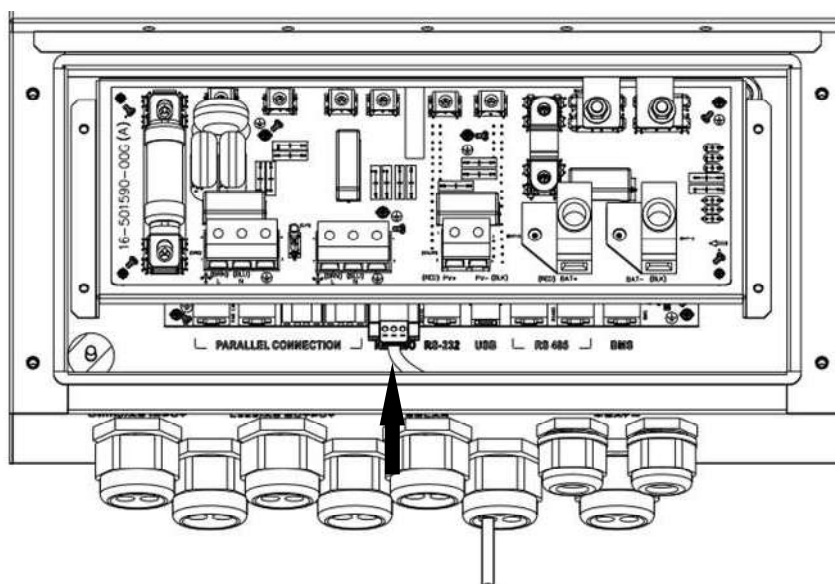

Unit Status	Condition		Dry contact port:		
			NC & C	NO & C	
Power Off	Unit is off and no output is powered.		Close	Open	
Power On	Output is powered from Utility.		Close	Open	
	Output is powered from Battery or Solar.	Program 01 set as SUB	Battery voltage < Low DC warning voltage	Open	Close
			Battery voltage > Setting value in Program 21 or battery charging reaches floating stage	Close	Open
	Output is powered from Battery or Solar.	Program 01 is set as SBU	Battery voltage < Setting value in Program 20	Open	Close
Battery voltage > Setting value in Program 21 or battery charging reaches floating stage			Close	Open	

OPERATION

Power ON/OFF

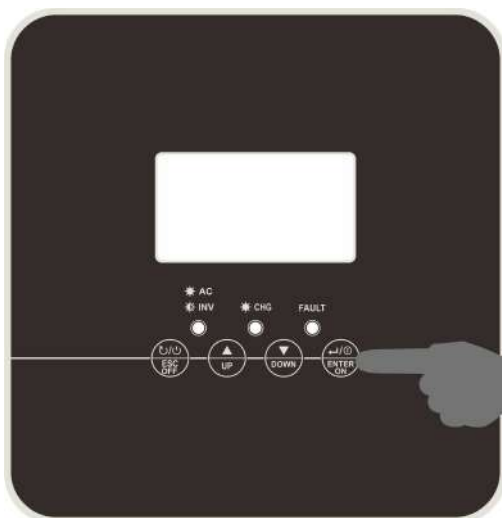

Power ON

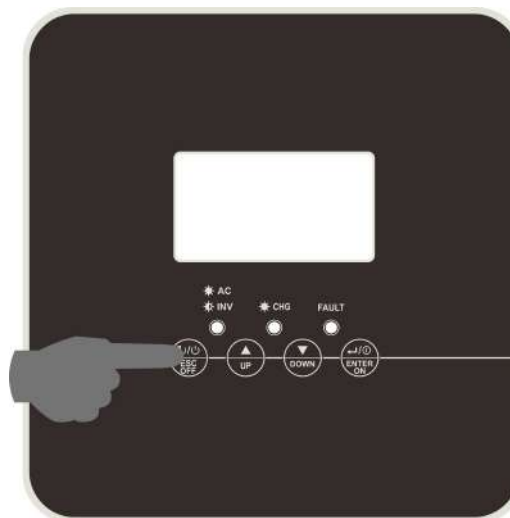

Power OFF

Once the unit has been properly installed and the batteries are connected well, simply press On key to turn on the unit (Press and hold the key more than 3s).

Operation and Display Panel

The operation and display panel, shown in below chart, is on the front panel of the inverter. It includes three indicators, four function keys and a LCD display, indicating the operating status and input/output power information.

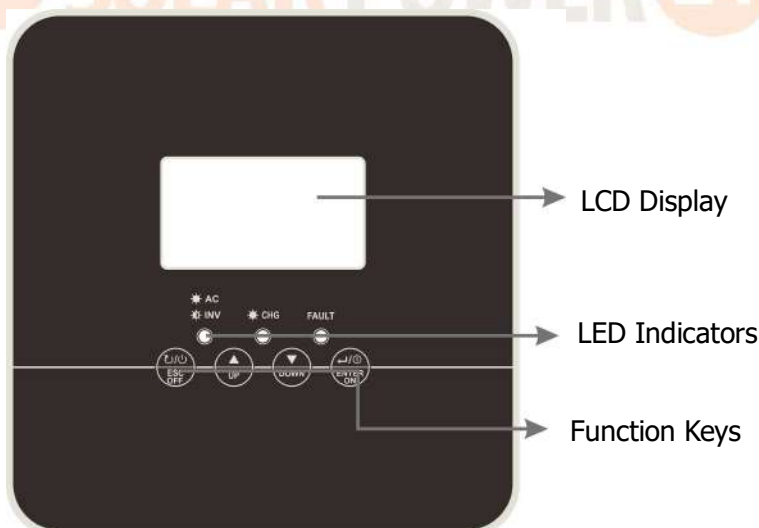

LED Indicator

LED Indicator		Messages	
☀️ AC / 🌙 INV	Green	Solid On	Output is powered by utility in Line mode.
		Flashing	Output is powered by battery or PV in battery mode.
☀️ CHG	Green	Solid On	Battery is fully charged.
		Flashing	Battery is charging.
⚠️ FAULT	Red	Solid On	Fault occurs in the inverter.
		Flashing	Warning condition occurs in the inverter.

Function Keys

Function Key	Description
ESC/OFF	1. To exit setting mode 2. Turn off the unit (Press and hold the key more than 3s)
UP	To go to previous selection
DOWN	To go to next selection
ENTER/ON	1. enter setting mode 2. Turn on the unit (Press and hold the key more than 3s)
DOWN+UP	To confirm the selection in setting mode(Press and hold the key more than 1s)

LCD Display Icons

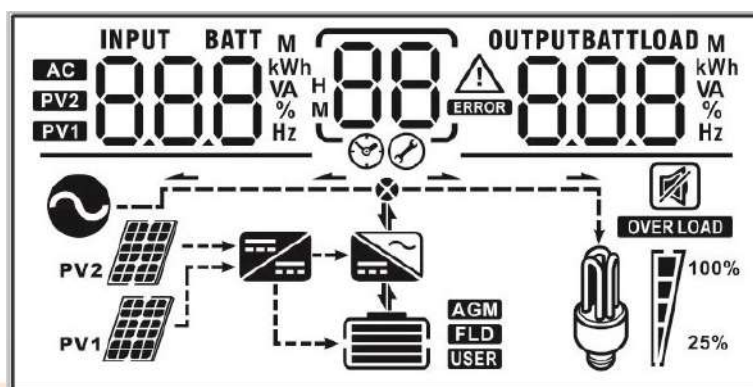

Icon	Function
Input source information	
AC	Indicates the AC input
PV1	Indicates the 1 st PV panel input
PV2	Indicates the 2 nd PV panel input
Left digital display information	
	Indicate input voltage, input frequency, battery voltage, PV1 voltage, PV2 voltage, charger current
Middle digital display information	
	Indicates the setting programs.
	Indicates the warning and fault codes. Warning: Flashing with warning code Fault: display with fault code
Right digital display information	
	Indicate the output voltage, output frequency, load percent, load VA, load W, PV1 charger power, PV2 charger power, DC discharging current.
Battery information	

	Indicates battery level by 0-24%, 25-49%, 50-74% and 75-100% and charging status.			
AGM FLD USER	Indicates the battery type: AGM, Flooded or User-defined battery.			
Load information				
OVER LOAD	Indicates overload.			
 100% 25%	Indicates the load level by 0-24%, 25-50%, 50-74%, and 75-100%.			
	0%~24%	25%~49%	50%~74%	75%~100%
Mode operation information				
	Indicates unit connects to the mains.			
PV1 	Indicates unit connects to the 1 st PV panel			
	Indicates the solar charger is working			
	Indicates the DC/AC inverter circuit is working.			
Mute operation				
	Indicates unit alarm is disabled.			

LCD Setting

After pressing and holding DOWN+UP button for 1 second, the unit will enter setting mode. Press "UP" or "DOWN" button to select setting programs. And then, press "ENTER" button to confirm the selection or ESC button to exit.

Program	Description	Selectable option	
00	Exit setting mode	Escape 	
01	Output source priority selection	SUB (default) 	Solar energy provides power to the loads as first priority. If solar energy is not sufficient to power all connected loads, Utility energy will supply power to the loads at the same time.
		SBU 	Solar energy provides power to the loads as first priority. If solar energy is not sufficient to power all connected loads, battery energy will supply power to the loads at the same time.









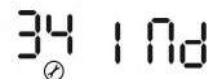

			Utility provides power to the loads only when battery voltage drops to either low-level warning voltage or the setting point in program 20 or solar and battery is not sufficient.
02	AC input voltage range	Appliances (default) 02 APL	If selected, acceptable AC input voltage range will be within 90-280VAC.
		UPS 02 UPS	If selected, acceptable AC input voltage range will be within 170-280VAC.
03	Output voltage	220Vac 03 220 ^v	230V (Default) 03 230 ^v
		240Vac 03 240 ^v	
04	Output frequency	50Hz (default) 04 50 ^{Hz}	60Hz 04 60 ^{Hz}
05	Solar supply priority	Charge first (default) 05 bLU	Solar energy provides power to charge battery as first priority.
		Load first 05 lBU	Solar energy provides power to the loads as first priority.
06	Overload bypass: When enabled, the unit will transfer to line mode if overload occurs in battery mode.	Bypass disable (default) 06 byd	Bypass enable 06 bYE
07	Auto restart when overload occurs	Restart disable (default) 07 lTd	Restart enable 07 lTE
08	Auto restart when over temperature occurs	Restart disable (default) 08 tTd	Restart enable 08 tTE
09	Solar energy feed to grid configuration	Feed to grid disable (default) 09 Gtd	Solar energy feed to grid disable.

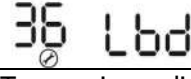

		Feed to grid enable 09 CFE	Solar energy feed to grid enable.
10	Charger source priority: To configure charger source priority	If this inverter/charger is working in Line, Standby or Fault mode, charger source can be programmed as below:	
		Solar first 10 C50	Solar energy will charge battery as first priority. Utility will charge battery only when solar energy is not available.
		Solar and Utility (default) 10 SNU	Solar energy and utility will charge battery at the same time.
		Only Solar 10 050	Solar energy will be the only charger source no matter utility is available or not.
		If this inverter/charger is working in Battery mode or Power saving mode, only solar energy can charge battery. Solar energy will charge battery if it's available and sufficient.	
11	Maximum charging current: To configure total charging current for solar and utility chargers. (Max. charging current = utility charging current + solar charging current)	60A (default) 11 60 ^A	For 2KW/3KW models, setting range is from 10A to 60A. For 5KW model, setting range is from 10A to 100A. Increment of each click is 10A.
13	Maximum utility charging current	2A 13 2 ^A	10A 13 10 ^A
		20A 13 20 ^A	30A (default) 13 30 ^A
		40A 13 40 ^A	50A 13 50 ^A
		60A 13 60 ^A	70A (only for 5KW model) 13 70 ^A

		80A (only for 5KW model) 13 80 ^A	90A (only for 5KW model) 13 90 ^A
		100A (only for 5KW model) 13 100 ^A	
14	Battery type	AGM (default) 14 AGM	Flooded 14 FLD
		User-Defined 14 USE	If "User-Defined" is selected, battery charge voltage and low DC cut-off voltage can be set up in program 17, 18 and 19.
17	Bulk charging voltage (C.V voltage)	default setting: 56.4V 17 56.4 ^v	
		If self-defined is selected in program 14, this program can be set up. Setting range is from 48.0V to 64.0V. Increment of each click is 0.1V.	
18	Floating charging voltage	default setting: 54.0V 18 54.0 ^v	
		If self-defined is selected in program 14, this program can be set up. Setting range is from 48.0V to 64.0V . Increment of each click is 0.1V.	
19	Low DC cut off battery voltage setting	default setting: 40.8V 19 40.8 ^v	
		If self-defined is selected in program 14, this program can be set up. Setting range is from 40.8V to 48.0V. Increment of each click is 0.1V. Low DC cut-off voltage will be fixed to setting value no matter what percentage of load is connected.	
20	Battery stop discharging voltage when grid is available	44.0V 20 44 ^v	45.0V 20 45 ^v
		46.0V (default) 20 46 ^v	47.0V 20 47 ^v

		48.0V 20 ^{BATT} 48v	49.0V 20 ^{BATT} 49v
		50.0V 20 ^{BATT} 50v	51.0V 20 ^{BATT} 51v
21	Battery stop charging voltage when grid is available	Battery fully charged 21 ^{BATT} FUL	48.0V 21 ^{BATT} 48.0v
		49.0V 21 ^{BATT} 49.0v	50.0V 21 ^{BATT} 50.0v
		51.0V 21 ^{BATT} 51.0v	52.0V 21 ^{BATT} 52.0v
		53.0V 21 ^{BATT} 53.0v	54.0V(default) 21 ^{BATT} 54.0v
		55.0V 21 ^{BATT} 55.0v	56.0V 21 ^{BATT} 56.0v
		57.0V 21 ^{BATT} 57.0v	58.0V 21 ^{BATT} 58.0v
22	Auto return to default display screen	Return to default display screen (default) 22 ^{ESP}	If selected, no matter how users switch display screen, it will automatically return to default display screen (Input voltage /output voltage) after no button is pressed for 1 minute.
		Stay at latest screen 22 ^{LEP}	If selected, the display screen will stay at latest screen user finally switches.
23	Backlight control	Backlight on (default) 23 ^{LON}	Backlight off 23 ^{LOF}

24	Alarm control	Alarm on (default) 24 <u>60N</u>	Alarm off 24 <u>60F</u>
25	Beeps while primary source is interrupted	Alarm on (default) 25 <u>A0N</u>	Alarm off 25 <u>A0F</u>
27	Record Fault code	Record enable(default) 27 <u>FEN</u>	Record disable 27 <u>FdS</u>
28	AC output mode *This setting is only available when the inverter is in standby mode (Switch off).	Single: This inverter is used in single phase application. 28 ^{OUTPUT} <u>SI C</u>	Parallel: This inverter is operated in parallel system. 28 ^{OUTPUT} <u>PAR</u>
		L1 phase 28 ^{OUTPUT} <u>3P1</u>	The inverter is operated in L1 phase in 3-phase application.
		L2 phase 28 ^{OUTPUT} <u>3P2</u>	The inverter is operated in L2 phase in 3-phase application.
		L3 phase 28 ^{OUTPUT} <u>3P3</u>	The inverter is operated in L3 phase in 3-phase application.
29	Reset PV energy storage	Not reset(Default) 29 <u>nr t</u>	Reset 29 <u>rSt</u>
30	Start charging time for AC charger	00:00 (Default) ^{BATT} 29 <u>StA</u> <u>30</u> <u>000</u>	The setting range of start charging time for AC charger is from 00:00 to 23:00, increment of each click is 1 hour.
31	Stop charging time for AC charger	00:00 (Default) ^{BATT} 29 <u>StO</u> <u>31</u> <u>000</u>	The setting range of stop charging time for AC charger is from 00:00 to 23:00, increment of each click is 1 hour.
32	Scheduled time for AC output on	00:00 (Default) ^{OUTPUT} 29 <u>On</u> <u>32</u> <u>000</u>	The setting range of scheduled Time for AC output on is from

		00:00 to 23:00, increment of each click is 1 hour.	
33	Scheduled time for AC output off	00:00(Default) 	The setting range of scheduled Time for AC output off is from 00:00 to 23:00, increment of each click is 1 hour.
34	Set country customized regulations	India(Default) 	If selected, acceptable feed-in grid voltage range will be 195.5~253VAC. Acceptable feed-in grid frequency range will be 49~51Hz.
		Germany 	If selected, acceptable feed-in grid voltage range will be 184~264.5VAC. Acceptable feed-in grid frequency range will be 47.5~51.5Hz.
		South America 	If selected, acceptable feed-in grid voltage range will be 184~264.5VAC. Acceptable feed-in grid frequency range will be 57~62Hz.
35	Modbus monitor ID	001(Default) 	Modbus ID setting: It's to set up inbuilt Modbus ID to facilitate inverter remote monitoring. In the same solar system, this ID no. should be unique. Setting range is from 001 to 247
36	Lithium battery turn-on when the device is powered on	Auto turn-on disable (default) 	Auto turn-on enable 
		Lithium battery turn-on immediately NOTE: This setting is effective only when setting 36 is set as "enable". 	Turn-on immediately enable 
95	Time setting – Minute		
		For minute setting, the range is from 00 to 59.	
96	Time setting – Hour		
		For hour setting, the range is from 00 to 23.	
97	Time setting– Day		
		For day setting, the range is from 01 to 31.	

98	Time setting– Month	 <p>For month setting, the range is from 01 to 12.</p>
99	Time setting – Year	 <p>For year setting, the range is from 18 to 99.</p>





Display Setting

The LCD display information will be switched in turns by pressing "UP" or "DOWN" key. The selectable information is switched as below order: input voltage, input frequency, PV voltage, charging current, battery voltage, output voltage, output frequency, load percentage, load in Watt, load in VA, load in Watt, DC discharging current, main board firmware version and SCC firmware version.

Select item	LCD display
Input voltage and output voltage (Default Display Screen)	<p>Input Voltage=230V, output voltage=230V</p>
Input frequency and output frequency	<p>Input frequency=50.0Hz, output frequency=50.0Hz</p>
Battery voltage and output voltage	<p>Battery Voltage=48.0V, output voltage=230V</p>
Battery voltage and load percentage	<p>Battery Voltage=48.0V, load percentage = 68%</p>

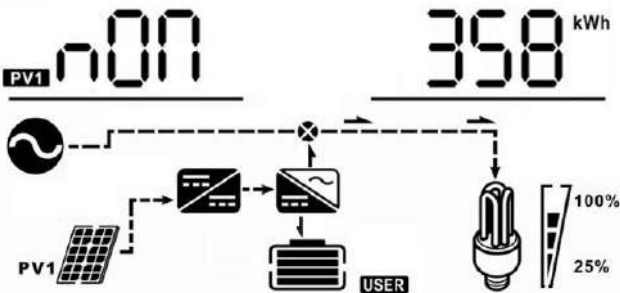
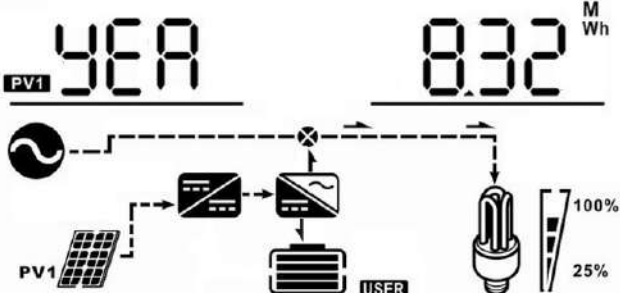
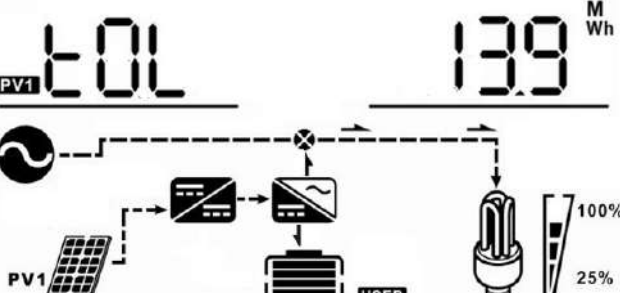
<p>Battery voltage and load in VA</p>	<p>Battery Voltage=48.0V, load in VA=1.08kVA</p>
<p>Battery voltage and load in Watt</p>	<p>Battery Voltage=48.0V, load in Watt=1.88kW</p>
<p>PV1 voltage and PV1 charger power</p>	<p>PV1 Voltage=360V, charging power=1.58kW</p>
<p>Charger current and DC discharging current</p>	<p>Charging current=30A, discharging current=0A</p>
<p>PV energy generated today</p>	<p>Today energy = 6.3kWh</p>

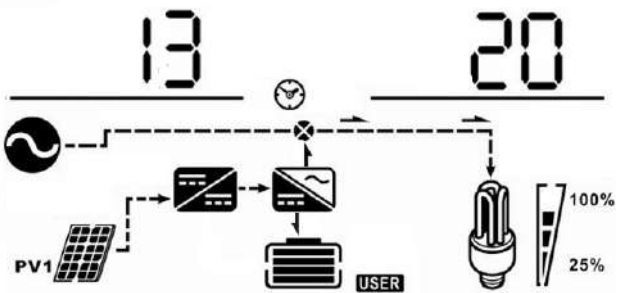
<p>PV energy generated this month</p>	<p>This month energy = 358kWh.</p> 
<p>PV energy generated this year</p>	<p>This year energy = 8.32MWh</p> 
<p>PV energy generated totally</p>	<p>Total energy = 13.9MWh</p> 
<p>Real date</p>	<p>Real date Nov 28, 2016.</p> 
<p>Real time</p>	<p>Real time 13:20.</p> 

Main board firmware version	Version 00001.00
-----------------------------	------------------











Operating Mode Description

Operating mode	Behaviors	LCD display
Standby mode Note: *Standby mode: The inverter is not turned on yet but at this time, the inverter can charge battery without AC output. *Power saving mode: If enabled, the output of inverter will be off when connected load is pretty low or not detected.	No output power, solar or utility charger available	Battery is charged by utility.
		Battery is charged by PV energy.
		Battery is charged by utility and PV energy.
		Battery is charged by PV energy and feed PV energy to grid.
		No charging.
Line mode	Output power from utility. Charger available	Utility charges battery and provides power to load.
		Utility and battery power provide power to load.















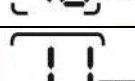

Line mode	Output power from utility. Charger available	<p>PV energy, battery power and utility provide power to load.</p>
	Output power from utility. Charger available	<p>PV energy and utility charge battery, and utility provides power to load.</p>
		<p>PV energy charges battery, utility and PV energy provide power to the load.</p>
		<p>PV energy charges battery, PV energy provides power to the load and feeds remaining energy to the grid.</p>
Battery mode	Output power from battery or PV	<p>PV energy and battery energy supply power to the load.</p>
		<p>PV energy charges battery and provides power to the load.</p>
		<p>Battery provides power to the load.</p>
Only PV mode	Output power from PV	<p>PV provides power to the load.</p>

<p>Fault mode</p> <p>Note: *Fault mode: Errors are caused by inside circuit error or external reasons such as over temperature, output short circuited and so on.</p>	<p>No output, no charging.</p>	<p>No charging.</p> 
----------------------------------------------------------------------------------------------------------------------------------------------------------------------------------	--------------------------------	---------------------------------------------------------------------------------------------------------

Warning Indicator

Warning Code	Warning Event	Icon flashing
01	Fan locked	
02	Over temperature	
03	Battery over charged	
04	Low battery	
07	Overload	  
10	Inverter power derating	
15	PV is weak	
BP	Battery is not connected	

Faults Reference Code

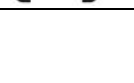
Fault Code	Fault Event	Icon on
01	Fan locked	
02	Over temperature	
03	Battery voltage is too high	
04	Battery voltage is too low	
05	Output short circuited	
06	Output voltage abnormal	
07	Over load time out	
08	Bus voltage is too high	
09	Bus soft start failed	
10	PV current over	
11	PV voltage over	
12	Charge current over	
51	Over current or surge	
52	Bus voltage is too low	
53	Inverter soft start failed	
55	Over DC offset in AC output	
56	Battery disconnected	
57	Current sensor failed	
58	Output voltage is too low	

SPECIFICATIONS

MODEL	2KW	3KW	5KW
RATED OUTPUT POWER	2000W	3000W	5000W
PV INPUT (DC)			
Max. PV Power	3000W	4500W	6000W
Max. PV Array Open Circuit Voltage	400 VDC	500 VDC	500 VDC
MPPT Range @ Operating Voltage	120 VDC~400 VDC	120 VDC~400 VDC	120 VDC~450 VDC
Max. PV Array Short Circuit Current	13A	18A	27A
Number of MPP Tracker	1		
GRID-TIE OPERATION			
GRID OUTPUT (AC)			
Nominal Output Voltage	220/230/240 VAC		
Feed-in Grid Voltage Range	195.5~253 VAC @India regulation 184 ~ 264.5 VAC @Germany regulation 184 ~ 264.5 VAC @South America regulation		
Feed-in Grid Frequency Range	49~51Hz @India regulation 47.5~51.5Hz @Germany regulation 57~62Hz @South America		
Nominal Output Current	8.7A	13A	21.7A
Power Factor Range	>0.99		
Maximum Conversion Efficiency (DC/AC)	95%		
OFF-GRID, HYBRID OPERATION			
GRID INPUT			
Acceptable Input Voltage Range	90 - 280 VAC or 170 - 280 VAC		
Frequency Range	50 Hz/60 Hz (Auto sensing)		
Transfer Time	< 10ms (for UPS) < 20ms (for home appliances) < 50ms (for parallel system operation)		
Rating of AC Transfer Relay	20A	30A	40A
BATTERY MODE OUTPUT (AC)			
Nominal Output Voltage	220/230/240 VAC		
Output Waveform	Pure Sine Wave		
Efficiency (DC to AC)	92%	93%	93%
BATTERY & CHARGER			
Nominal DC Voltage	48 VDC		
Maximum Charging Current (from Grid)	40A	60A	100A
Maximum Charging Current (from PV)	40A	60A	100A
Maximum Charging Current	40A	60A	100A
GENERAL			
Dimension, D X W X H (mm)	200 x 360 x 665		
Net Weight (kgs)	22.5	22.5	22.5
INTERFACE			
Parallel-able	Yes		
External Safety Box (Optional)	Yes		
Communication	USB or RS232 / RS 485		
ENVIRONMENT			
Humidity	0 ~ 95% RH (No condensing)		
Operating Temperature	-25°C to 50°C		

TROUBLE SHOOTING

Problem	LCD/LED/Buzzer	Explanation / Possible cause	What to do
Unit shuts down automatically during startup process.	LCD/LEDs and buzzer will be active for 3 seconds and then complete off.	The battery voltage is too low (<1.91V/Cell)	1. Re-charge battery. 2. Replace battery.
No response after power on.	No indication.	1. The battery voltage is far too low. (<1.4V/Cell) 2. Battery polarity is connected reversed.	1. Check if batteries and the wiring are connected well. 2. Re-charge battery. 3. Replace battery.
Mains exist but the unit works in battery mode.	Input voltage is displayed as 0 on the LCD and green LED is flashing.	Input protector is tripped	Check if AC breaker is tripped and AC wiring is connected well.
	Green LED is flashing.	Insufficient quality of AC power. (Shore or Generator)	1. Check if AC wires are too thin and/or too long. 2. Check if generator (if applied) is working well or if input voltage range setting is correct. (UPS→Appliance)
	Green LED is flashing.	Set "Solar First" as the priority of output source.	Change output source priority to Utility first.
When the unit is turned on, internal relay is switched on and off repeatedly.	LCD display and LEDs are flashing	Battery is disconnected.	Check if battery wires are connected well.
Buzzer beeps continuously and red LED is on.	Fault code 07	Overload error. The inverter is overload 110% and time is up.	Reduce the connected load by switching off some equipment.
	Fault code 05	Output short circuited.	Check if wiring is connected well and remove abnormal load.
	Fault code 02	Internal temperature of inverter component is over 100°C.	Check whether the air flow of the unit is blocked or whether the ambient temperature is too high.
	Fault code 03	Battery is over-charged.	Return to repair center.
		The battery voltage is too high.	Check if spec and quantity of batteries are meet requirements.
	Fault code 01	Fan fault	Replace the fan.
	Fault code 06/58	Output abnormal (Inverter voltage below than 190Vac or is higher than 260Vac)	1. Reduce the connected load. 2. Return to repair center
	Fault code 08/09/53/57	Internal components failed.	Return to repair center.
	Fault code 10	Surge	Restart the unit, if the error happens again, please return to repair center.
	Fault code 12	DC/DC over current or surge.	
	Fault code 51	Over current or surge.	
	Fault code 52	Bus voltage is too low.	
	Fault code 55	Output voltage is unbalanced.	
Fault code 56	Battery is not connected well or fuse is burnt.	If the battery is connected well, please return to repair center.	
Fault code 11	Solar input voltage is more than 450V.	Solar input voltage is more than 450V.	

Appendix I: Parallel function

1. Introduction

This inverter can be used in parallel with two different operation modes.

1. Parallel operation in single phase with up to 9 units. The supported maximum output power for 2KW is 18KW/18KVA, for 3KW is 27KW/27KVA and for 5KW is 45KW/45KVA.
2. Maximum nine units work together to support three-phase equipment. Seven units support one phase maximum. For 2KW, the supported maximum output power is 18KW/18KVA and one phase can be up to 14KW/14KVA. For 3KW, the supported maximum output power is 27KW/27KVA and one phase can be up to 21KW/21KVA. For 5KW, the supported maximum output power is 45KW/45KVA and one phase can be up to 35KW/35KVA.

2. Mounting the Unit

When installing multiple units, please follow below chart.

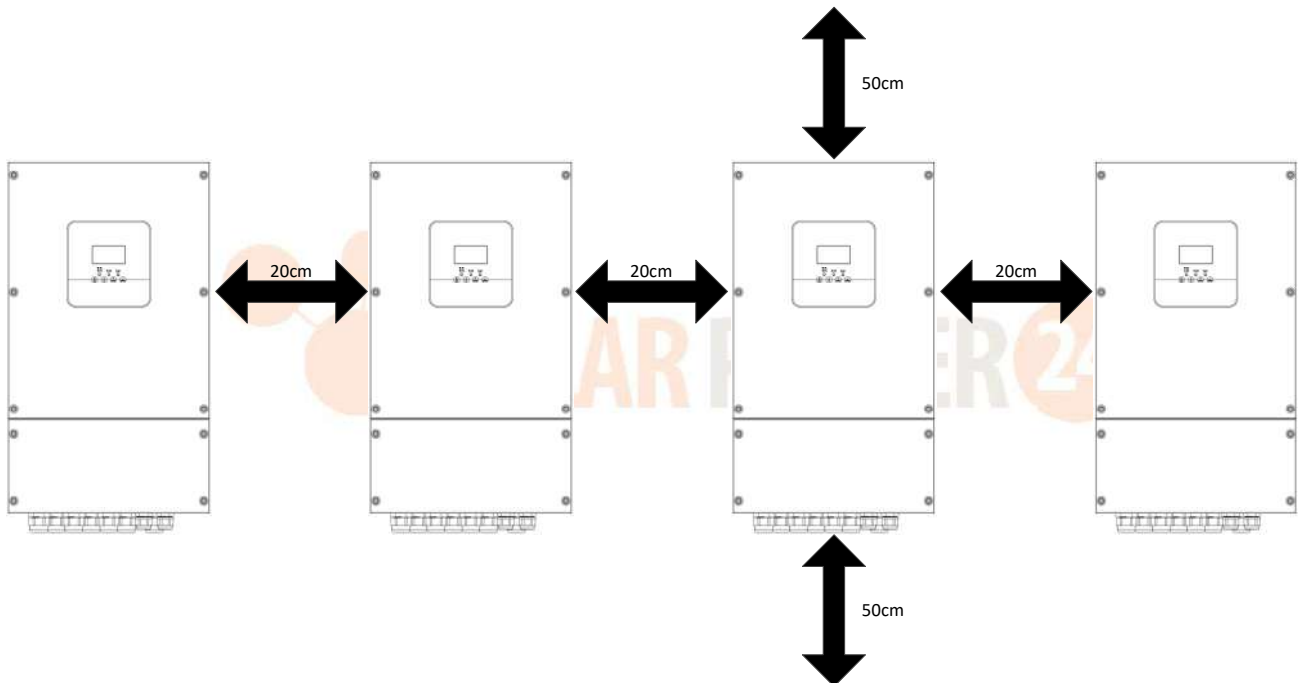

NOTE: For proper air circulation to dissipate heat, allow a clearance of approx. 20 cm to the side and approx. 50 cm above and below the unit. Be sure to install each unit at the same level.

3. Wiring Connection

NOTICE: It's requested to connect to battery for parallel operation.

The cable size of each inverter is shown as below:

Recommended battery cable and terminal size for each inverter:

Model	AWG no.	Torque
2KW	1*4AWG	2~ 3 Nm
3KW	1*4AWG	2~ 3 Nm
5KW	1*2AWG	2~ 3 Nm

WARNING: Be sure the length of all battery cables is the same. Otherwise, there will be voltage difference between inverter and battery to cause parallel inverters not working.

Recommended AC input and output cable size for each inverter:

Model	AWG no.	Torque
2KW	10 AWG	1.2~1.6Nm
3KW	10 AWG	1.2~1.6Nm
5KW	10 AWG	1.2~1.6Nm

You need to connect the cables of each inverter together. Take the battery cables for example: You need to use a connector or bus-bar as a joint to connect the battery cables together, and then connect to the battery terminal. The cable size used from joint to battery should be X times cable size in the tables above. "X" indicates the number of inverters connected in parallel.

Regarding AC input and output, please also follow the same principle.

WARNING!! Make sure all output N wires of each inverter must be connected all the time. Otherwise, it will cause inverter fault in error code #72.

CAUTION!! Please install the breaker at the battery and AC input side. This will ensure the inverter can be securely disconnected during maintenance and fully protected from over current of battery or AC input. The recommended mounted location of the breakers is shown in the figures in 5-1 and 5-2.

Recommended breaker specification of battery for each inverter:

Model	1 unit*
2KW	80A/70VDC
3KW	100A/70VDC
5KW	140A/70VDC

*If you want to use only one breaker at the battery side for the whole system, the rating of the breaker should be X times current of 1 unit. "X" indicates the number of inverters connected in parallel.

Recommended breaker specification of AC input with single phase:

Model	2 units	3 units	4 units	5 units	6 units	7 units	8 units	9 units
2KW	80A/ 230VAC	120A/ 230VAC	160A/ 230VAC	200A/ 230VAC	240A/ 230VAC	280A/ 230VAC	320A/ 230VAC	360A/ 230VAC
3KW	80A/ 230VAC	120A/ 230VAC	160A/ 230VAC	200A/ 230VAC	240A/ 230VAC	280A/ 230VAC	320A/ 230VAC	360A/ 230VAC
5KW	80A/ 230VAC	120A/ 230VAC	160A/ 230VAC	200A/ 230VAC	240A/ 230VAC	280A/ 230VAC	320A/ 230VAC	360A/ 230VAC

Note1: Also, you can use 40A breaker for 2KW and 50A for 3KW/5KW for only 1 unit and install one breaker at its AC input in each inverter.

Note2: Regarding three-phase system, you can use 4-pole breaker directly and the rating of the breaker should be compatible with the phase current limitation from the phase with maximum units

Recommended battery capacity

Inverter parallel numbers	2	3	4	5	6	7	8	9
Battery Capacity for 2KW	200AH	400AH	400AH	600AH	600AH	800AH	800AH	1000AH
Battery Capacity for 3KW	400AH	600AH	800AH	1000AH	1200AH	1400AH	1600AH	1800AH
Battery Capacity for 5KW	400AH	600AH	800AH	1000AH	1200AH	1400AH	1600AH	1800AH

WARNING! Be sure that all inverters will share the same battery bank. Otherwise, the inverters will transfer to fault mode.

4-1. Parallel Operation in Single phase

Two inverters in parallel:

Power Connection

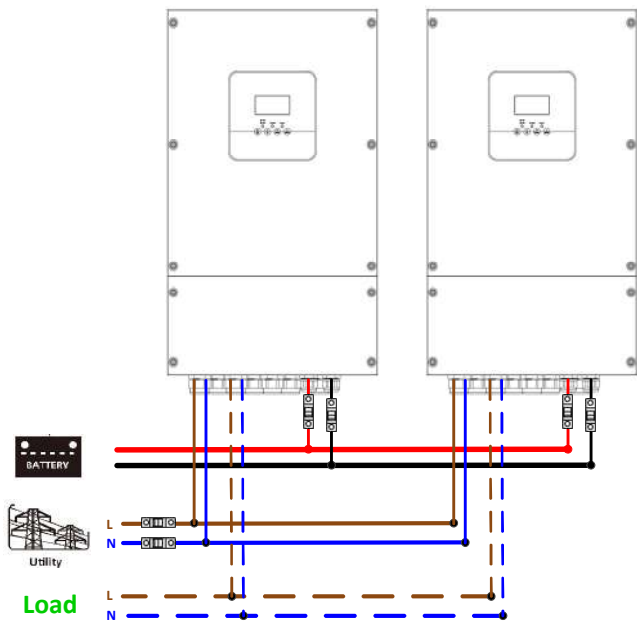

Communication Connection

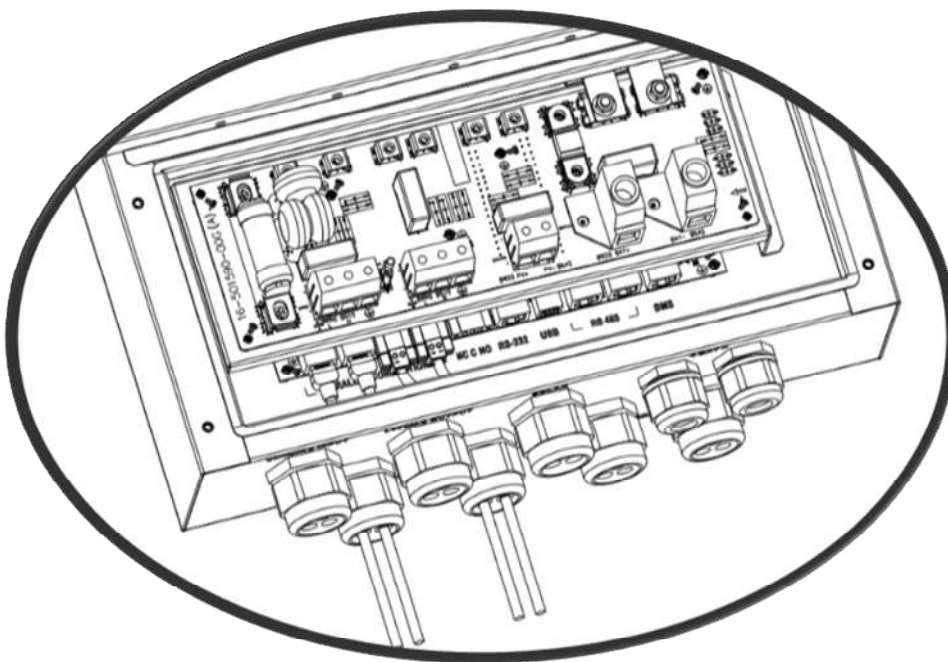
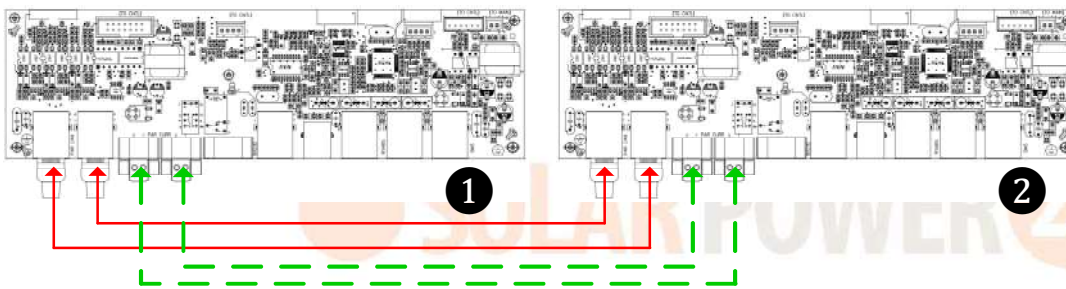

Three inverters in parallel:

Power Connection

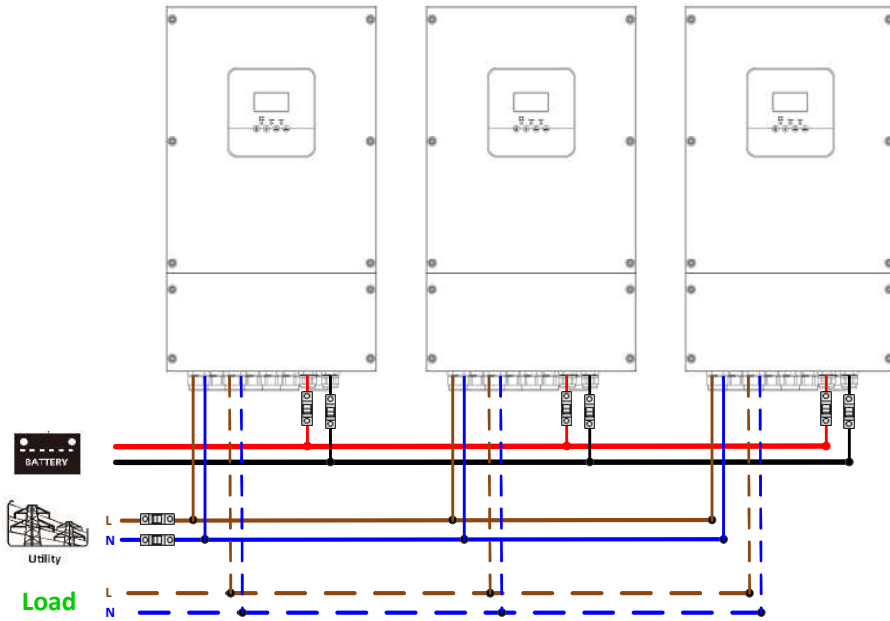

Communication Connection

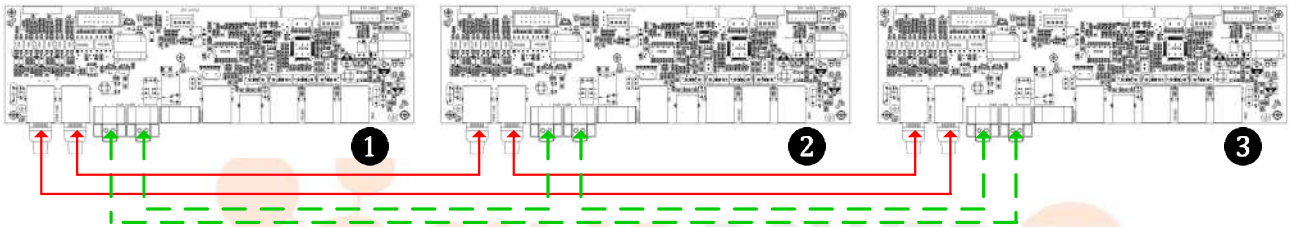

Four inverters in parallel:

Power Connection

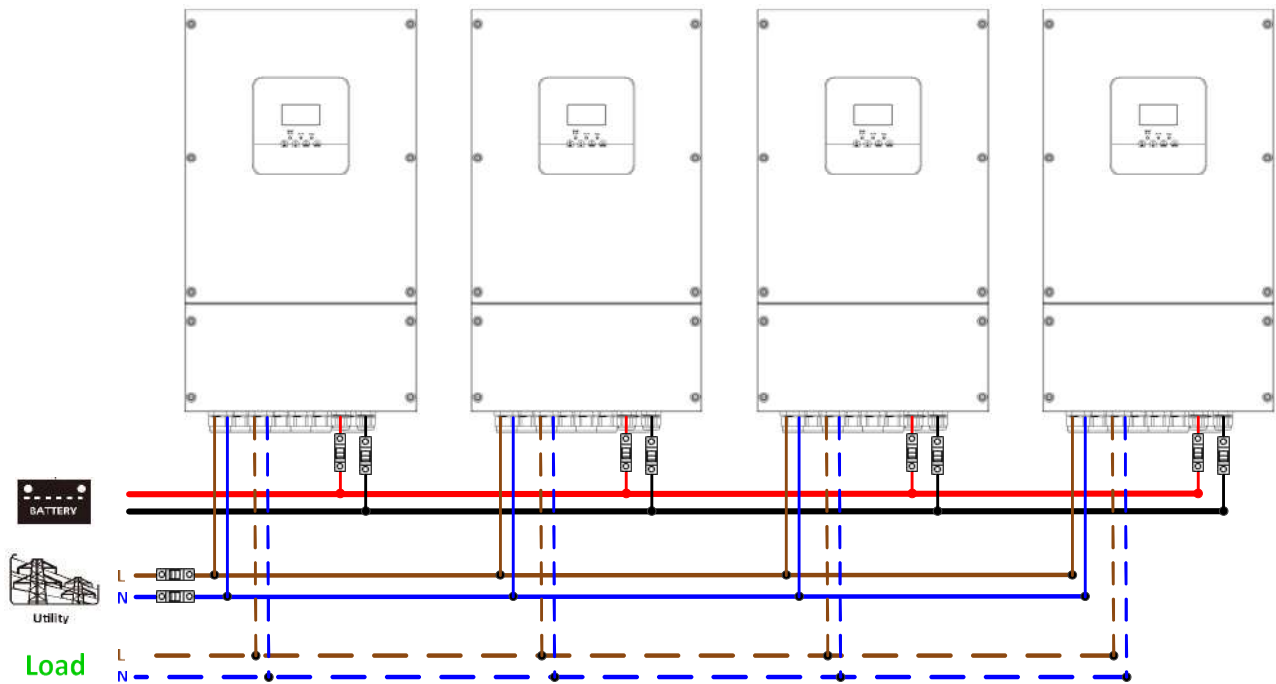

Communication Connection

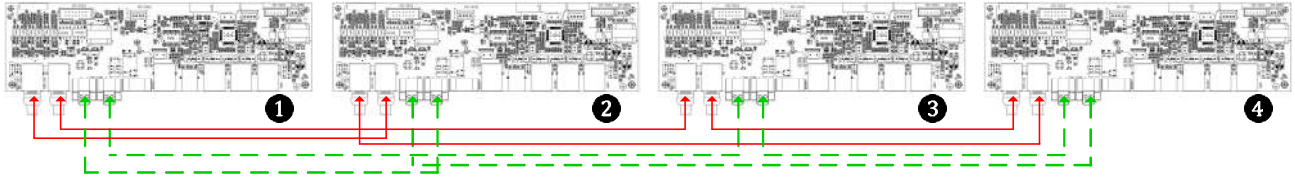

Five inverters in parallel:

Power Connection

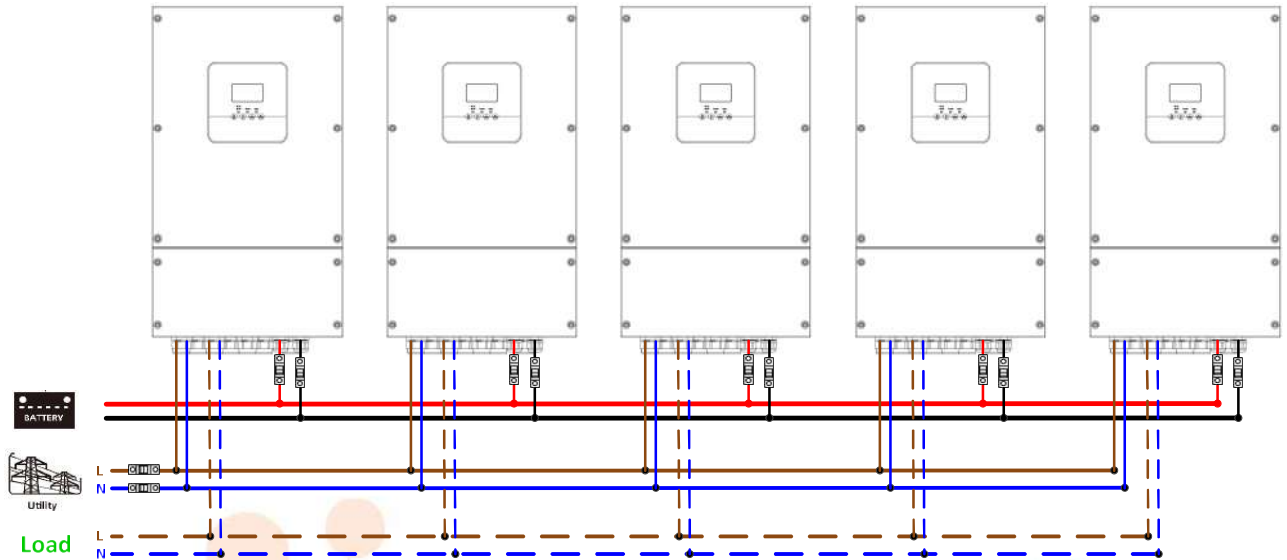

Communication Connection

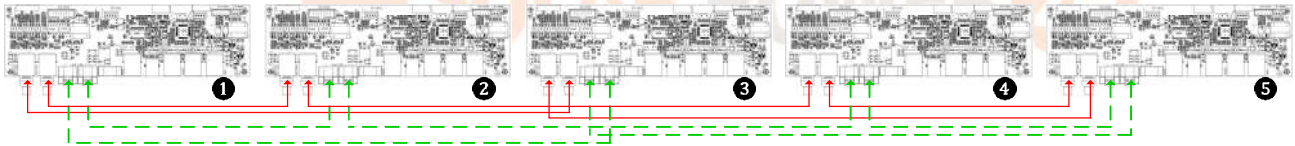

Six inverters in parallel:

Power Connection

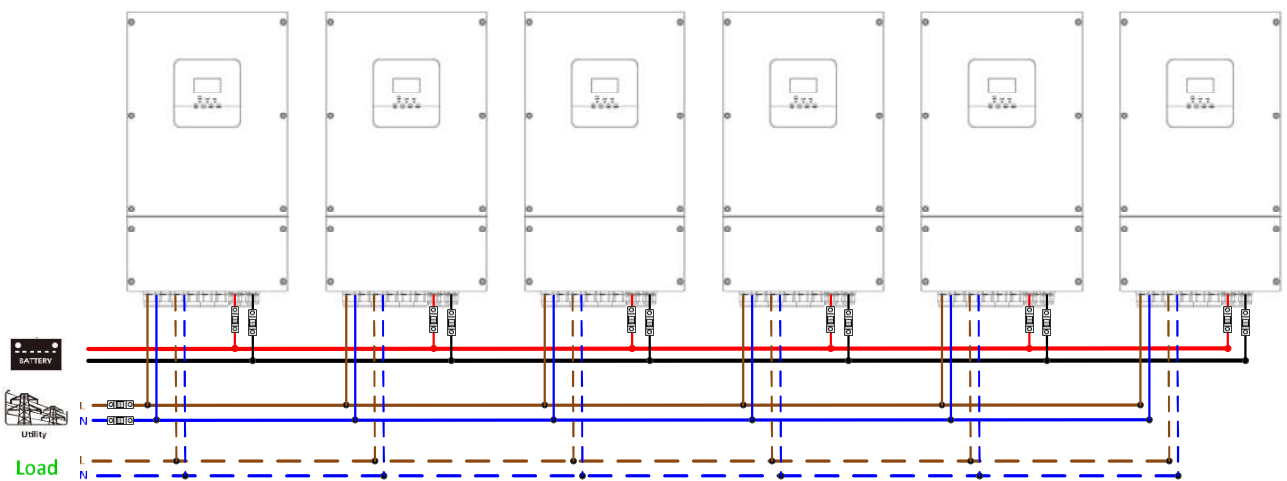

Communication Connection

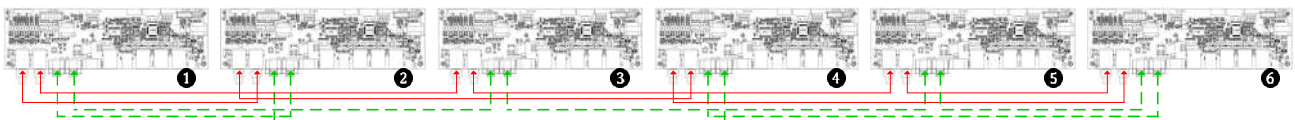

Seven to nine inverters in parallel:

Power Connection

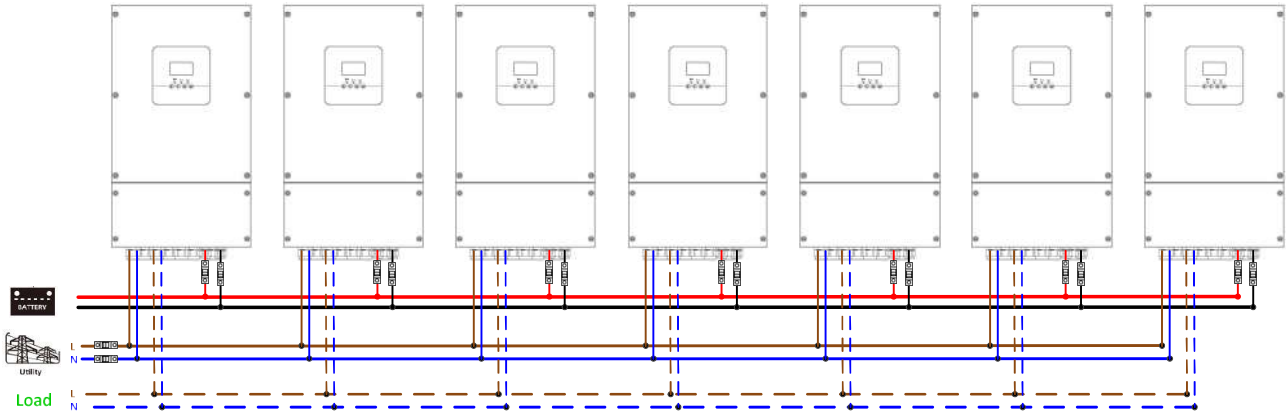

Communication Connection

➤ Seven inverters in parallel

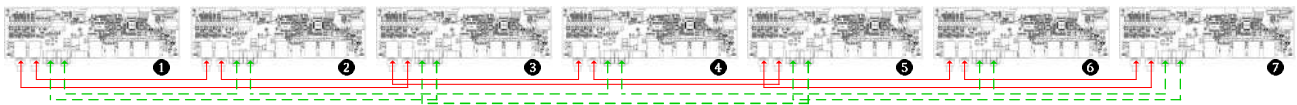

➤ Eight inverters in parallel

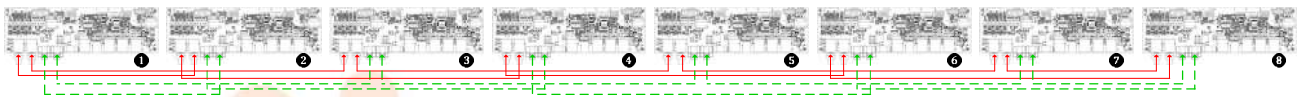

➤ Nine inverters in parallel



4-2. Support 3-phase equipment

Three inverters in each phase:

Power Connection

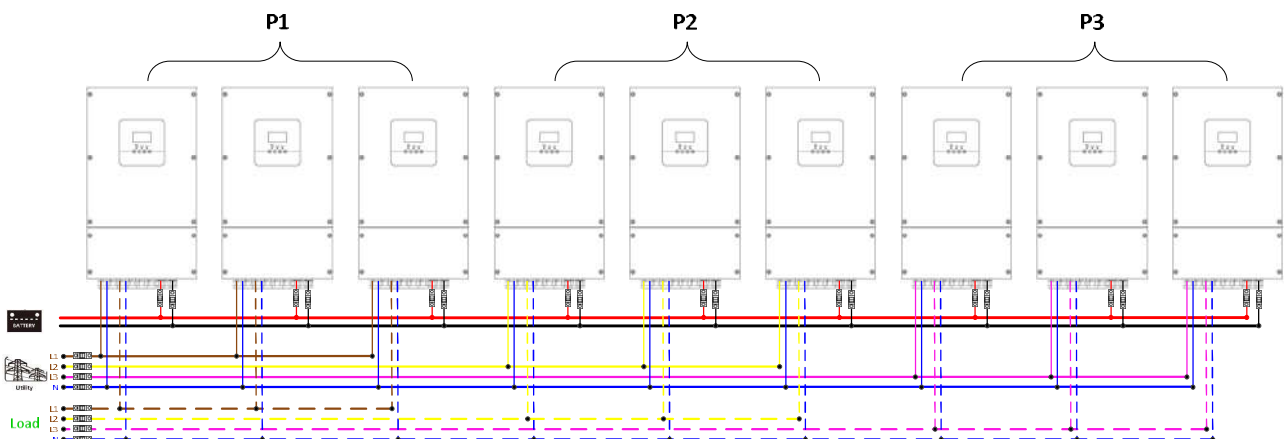

Communication Connection

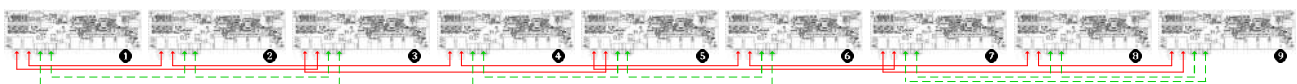

Three inverters in one phase, three inverters in second phase and two inverter for the third phase:

Power Connection

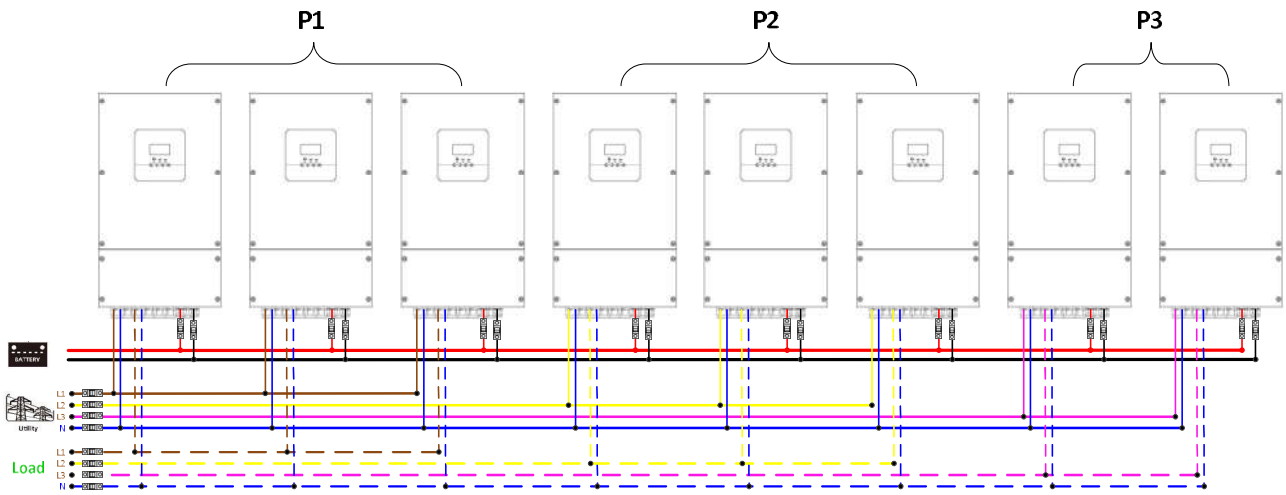

Communication Connection

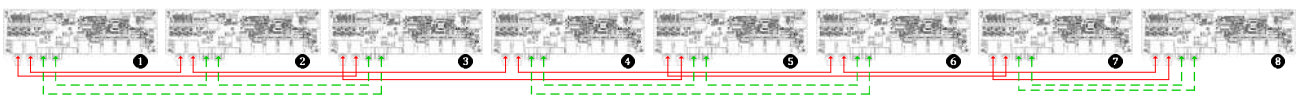

Three inverters in one phase, two inverters in second phase and two inverters for the third phase:

Power Connection

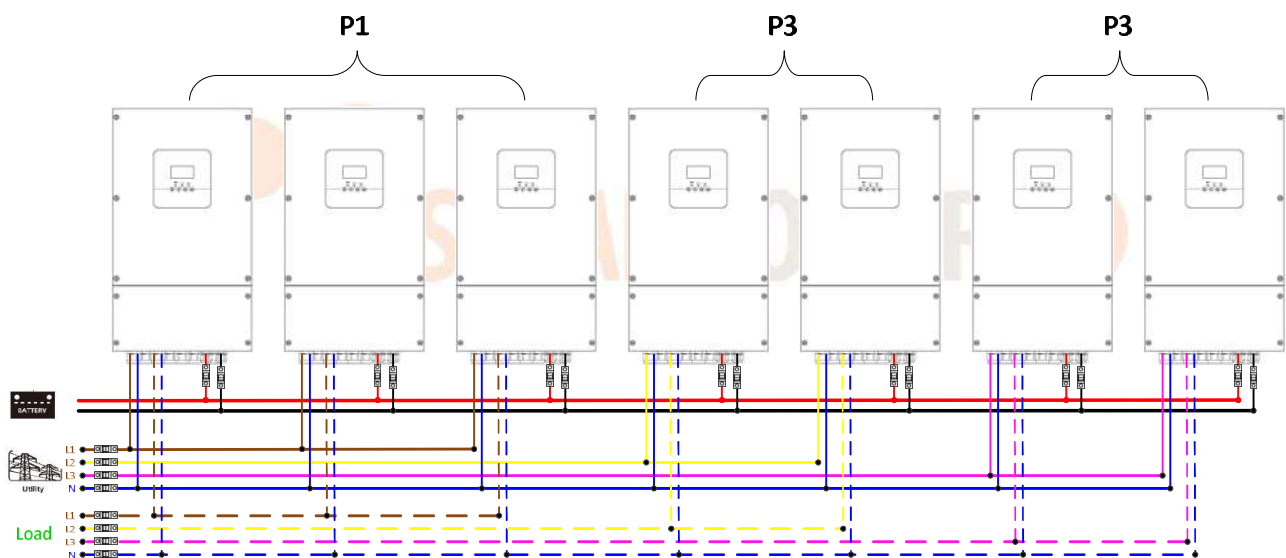

Communication Connection



Two inverters in each phase:

Power Connection

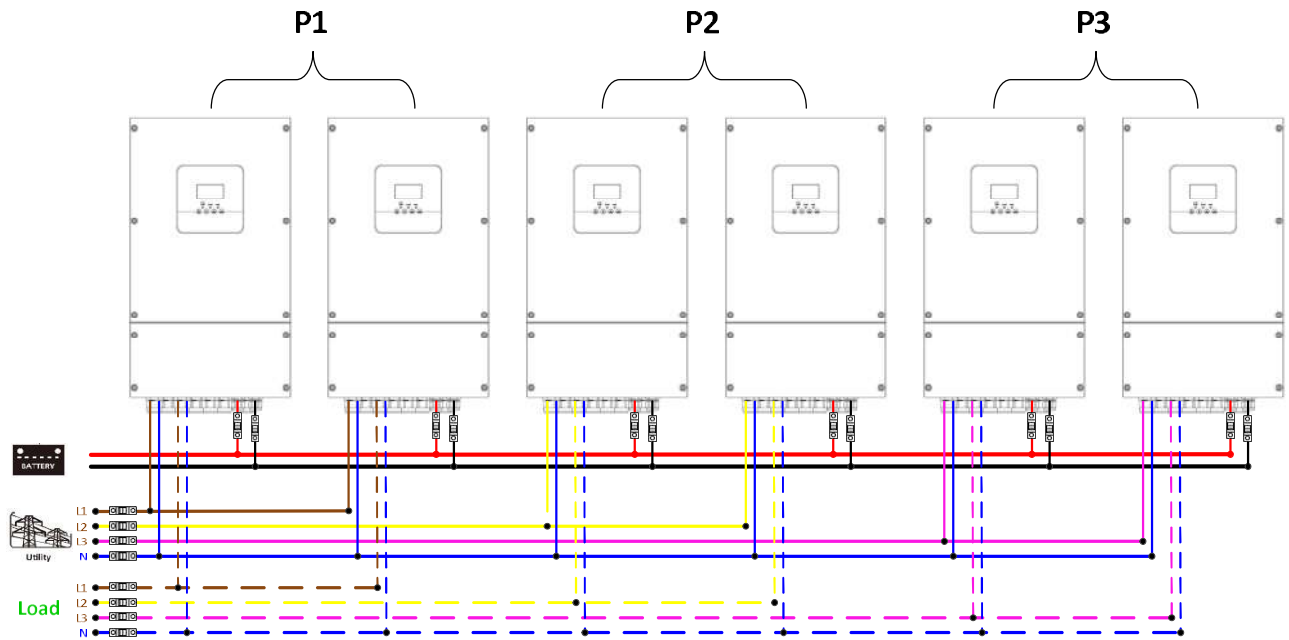

Communication Connection

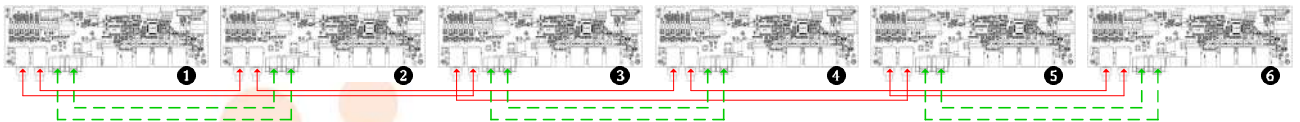

Four inverters in one phase and one inverter for the other two phases:

Power Connection

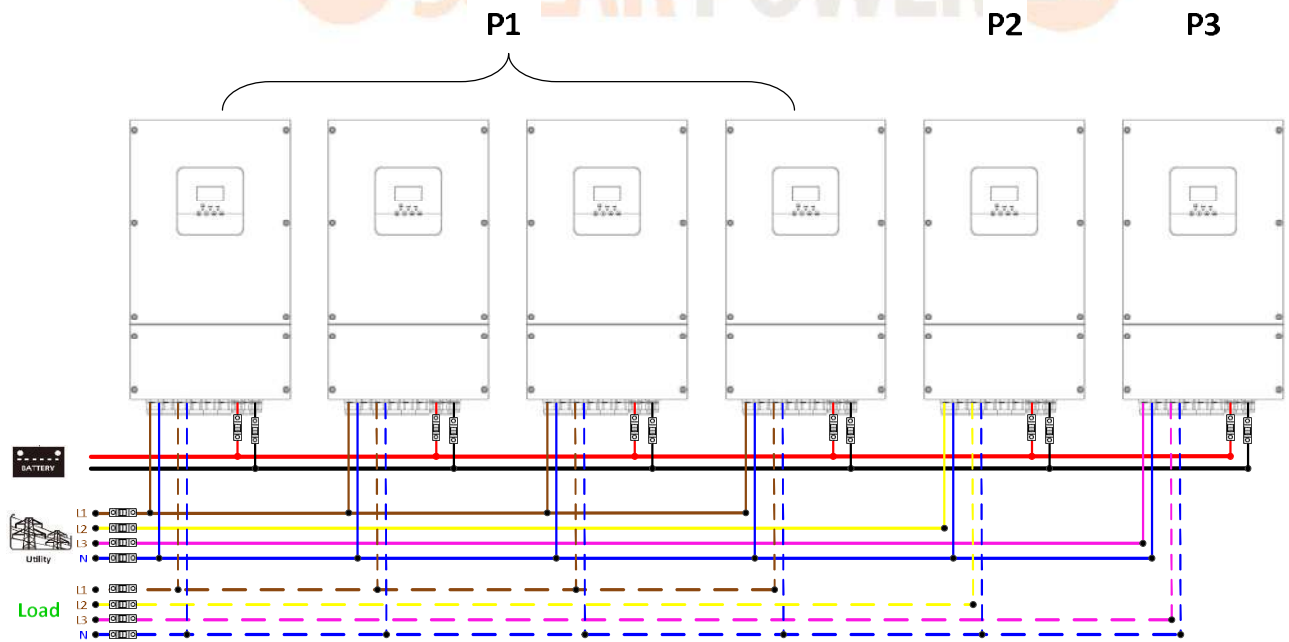

Communication Connection

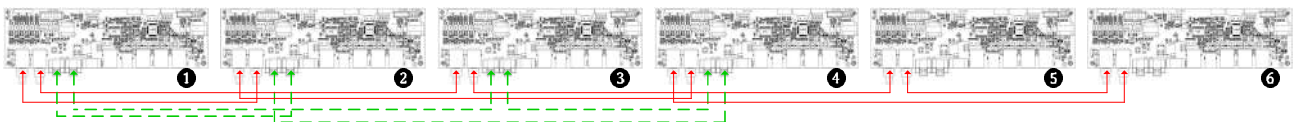

Three inverters in one phase, two inverters in second phase and one inverter for the third phase:

Power Connection

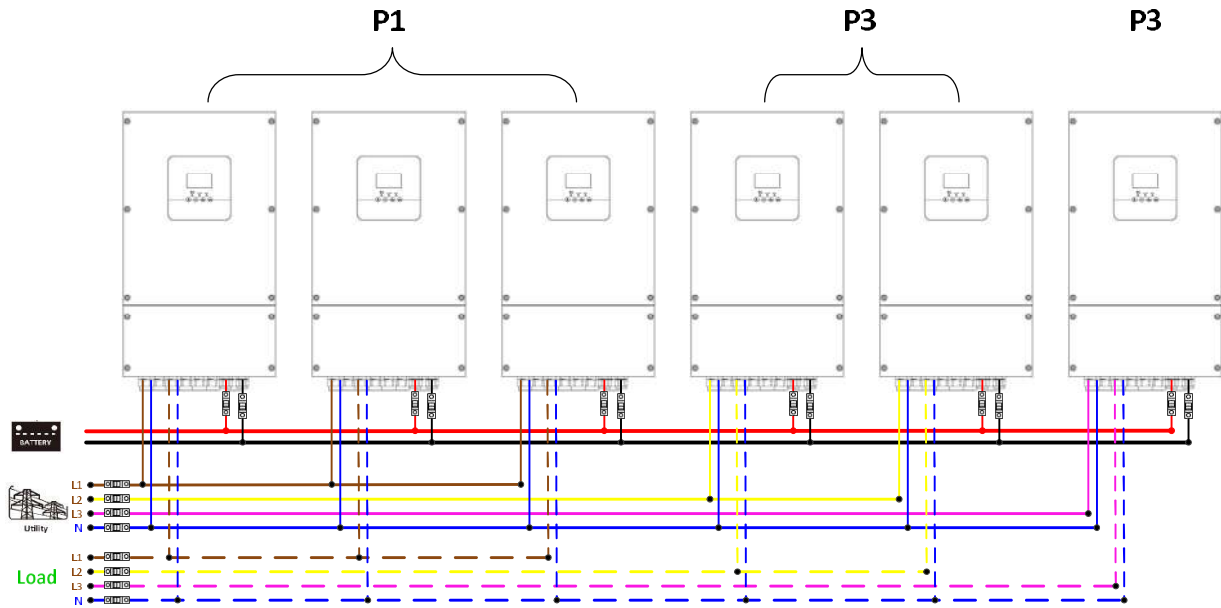

Communication Connection

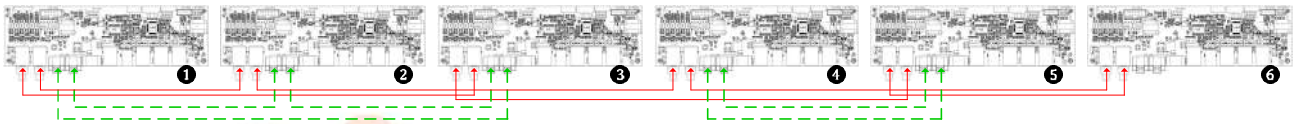

Three inverters in one phase and only one inverter for the remaining two phases:

Power Connection

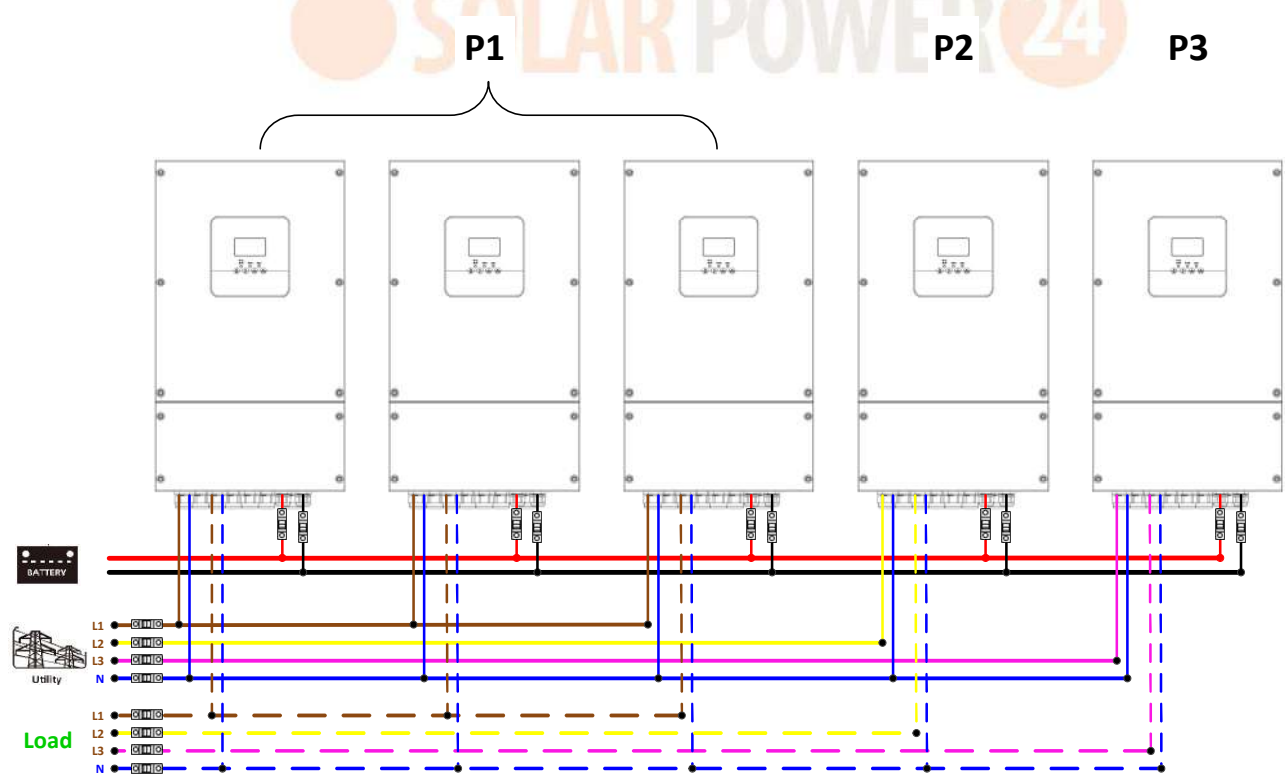

Communication Connection

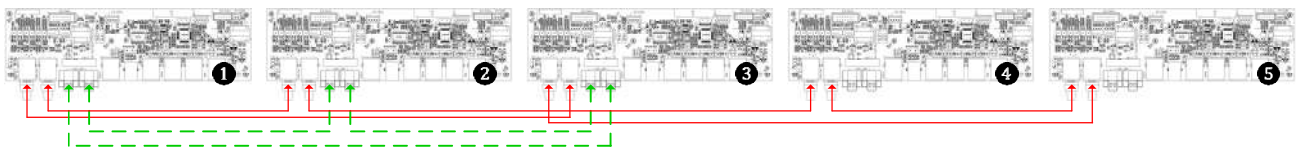

Two inverters in two phases and only one inverter for the remaining phase:

Power Connection

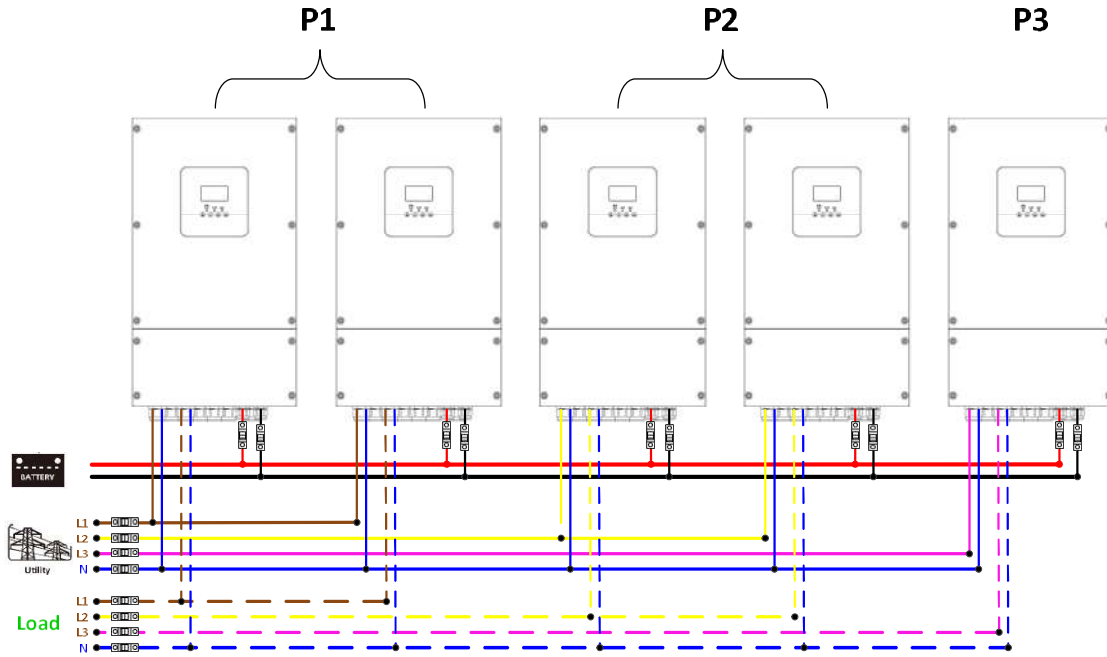

Communication Connection

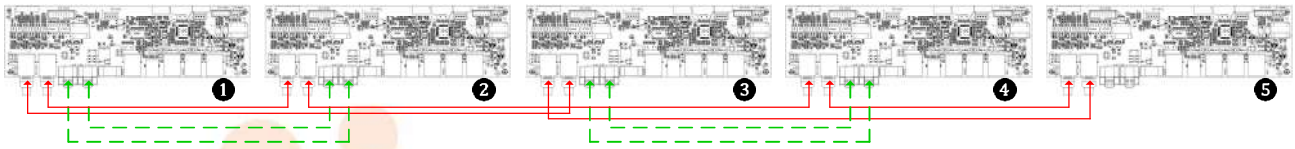

Two inverters in one phase and only one inverter for the remaining phases:

Power Connection

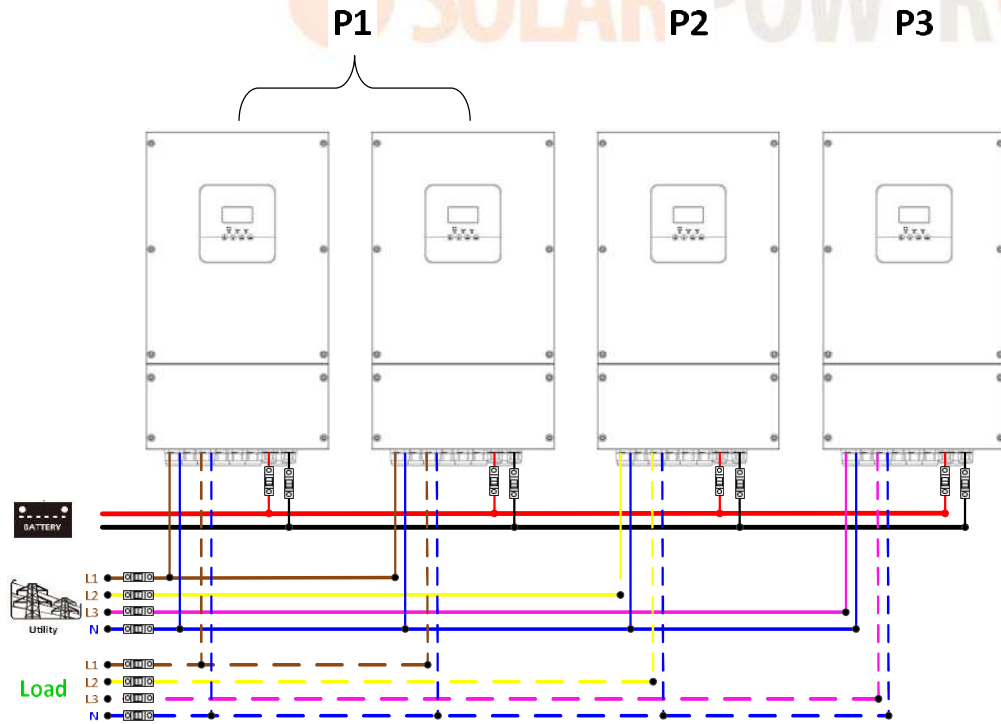

Communication Connection

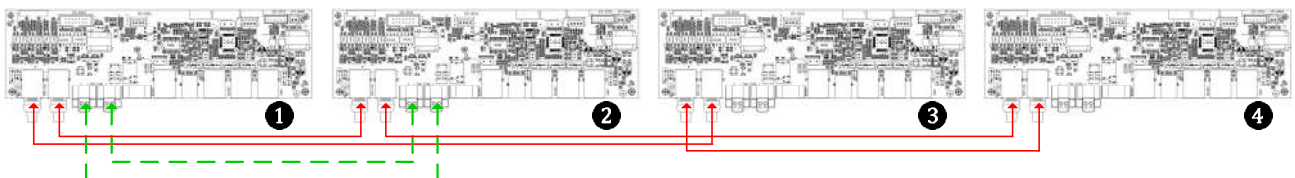

One inverter in each phase:

Power Connection

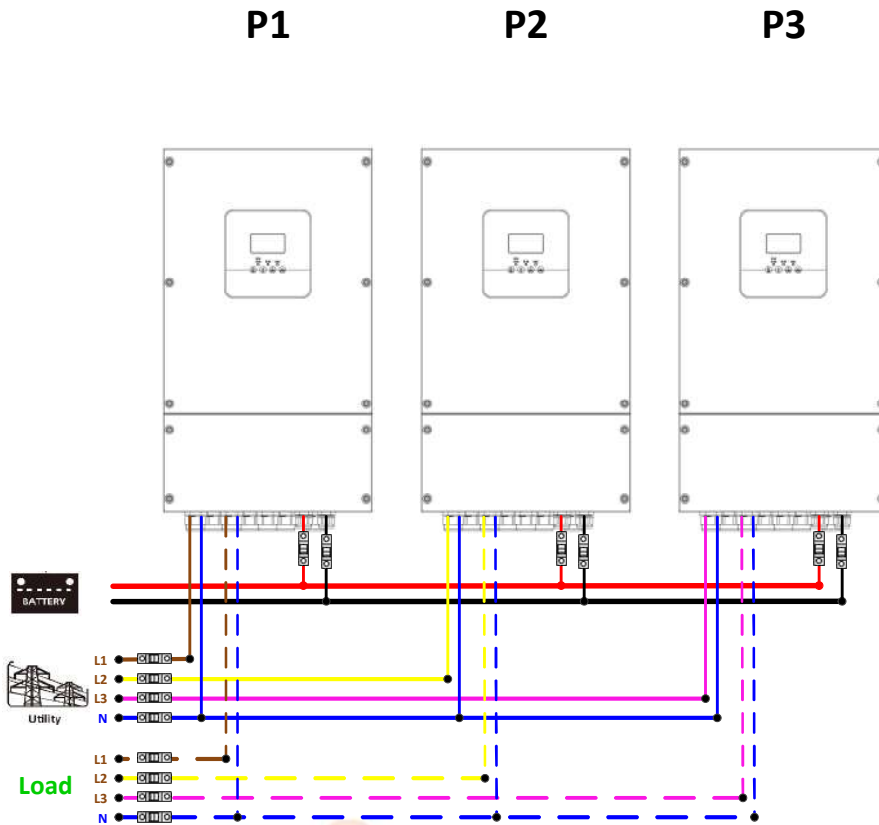

Communication Connection

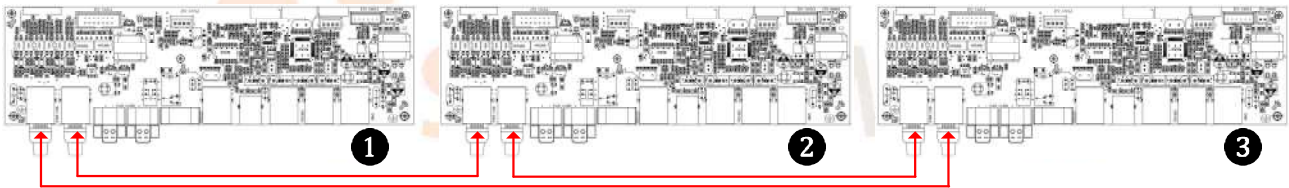

WARNING: Do not connect the current sharing cable between the inverters which are in different phases. Otherwise, it may damage the inverters.

5. PV Connection

Please refer to user manual of single unit for PV Connection.

CAUTION: Each inverter should connect to PV modules separately.

6. LCD Setting and Display

Setting Program:

Program	Description	Selectable option	
28	AC output mode *This setting is only available when the inverter is in standby mode (Switch off).	Single: 28 ^{OUTPUT} 51 0	When the units are used in parallel with single phase, please select "PAL" in program 28.
		Parallel: 28 ^{OUTPUT} PAL	It is required to have at least 3 inverters or maximum 6 inverters to support three-phase equipment. It's required to have at least one inverter in each phase or it's up to four inverters in one phase. Please refers to 5-2 for detailed information. Please select "3P1" in program 28 for the inverters connected to L1 phase, "3P2" in program 28 for the inverters connected to L2 phase and "3P3" in program 28 for the inverters connected to L3 phase.
		L1 phase: 28 ^{OUTPUT} 3P 1	
		L2 phase: 28 ^{OUTPUT} 3P 2	Be sure to connect share current cable to units which are on the same phase. Do NOT connect share current cable between units on different phases.
		L3 phase: 28 ^{OUTPUT} 3P 3	Besides, power saving function will be automatically disabled.

Fault code display:

Fault Code	Fault Event	Icon on
60	Power feedback protection	
71	Firmware version inconsistent	
72	Current sharing fault	
80	CAN fault	
81	Host loss	
82	Synchronization loss	
83	Battery voltage detected different	
84	AC input voltage and frequency detected different	
85	AC output current unbalance	
86	AC output mode setting is different	

7. Commissioning

Parallel in single phase

Step 1: Check the following requirements before commissioning:

- Correct wire connection
- Ensure all breakers in Line wires of load side are open and each Neutral wires of each unit are connected together.

Step 2: Turn on each unit and set "PAL" in LCD setting program 28 of each unit. And then shut down all units.

NOET: It's necessary to turn off switch when setting LCD program. Otherwise, the setting can not be programmed.

Step 3: Turn on each unit.

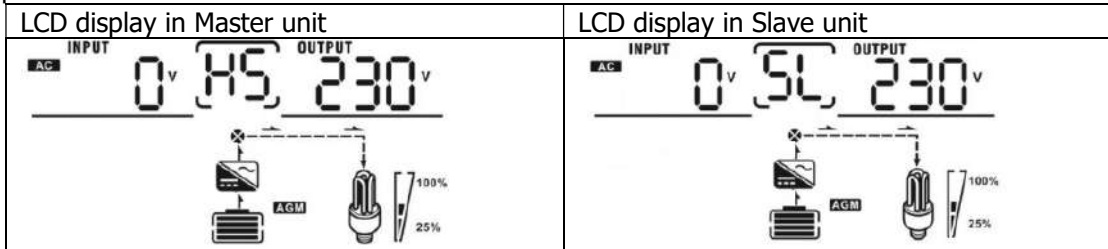

NOTE: Master and slave units are randomly defined.

Step 4: Switch on all AC breakers of Line wires in AC input. It's better to have all inverters connect to utility at the same time. If not, it will display fault 82 in following-order inverters. However, these inverters will automatically restart. If detecting AC connection, they will work normally.

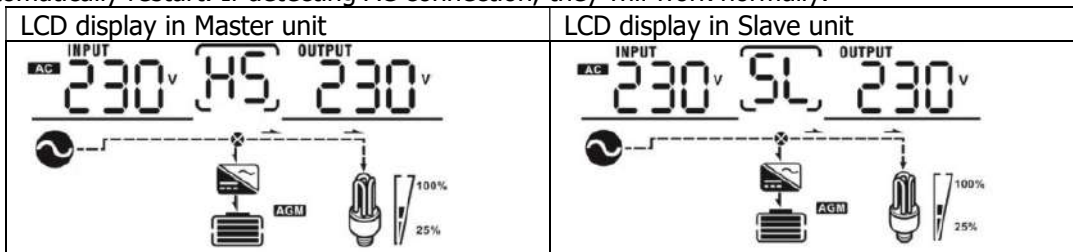

Step 5: If there is no more fault alarm, the parallel system is completely installed.

Step 6: Please switch on all breakers of Line wires in load side. This system will start to provide power to the load.

Support three-phase equipment

Step 1: Check the following requirements before commissioning:

- Correct wire connection
- Ensure all breakers in Line wires of load side are open and each Neutral wires of each unit are connected together.

Step 2: Turn on all units and configure LCD program 28 as P1, P2 and P3 sequentially. And then shut down all units.

NOET: It's necessary to turn off switch when setting LCD program. Otherwise, the setting can not be programmed.

Step 3: Turn on all units sequentially.



Step 4: Switch on all AC breakers of Line wires in AC input. If AC connection is detected and three phases are matched with unit setting, they will work normally. Otherwise, the AC icon will flash and they will not work in line mode.

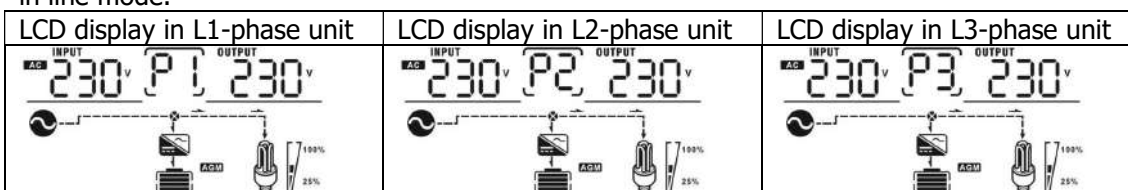

Step 5: If there is no more fault alarm, the system to support 3-phase equipment is completely installed.

Step 6: Please switch on all breakers of Line wires in load side. This system will start to provide power to the load.

Note 1: To avoid overload occurring, before turning on breakers in load side, it's better to have whole system in operation first.

Note 2: Transfer time for this operation exists. Power interruption may happen to critical devices, which cannot bear transfer time.

8. Trouble shooting

Situation		Solution
Fault Code	Fault Event Description	
60	Current feedback into the inverter is detected.	<ol style="list-style-type: none"> 1. Restart the inverter. 2. Check if L/N cables are not connected reversely in all inverters. 3. For parallel system in single phase, make sure the sharing are connected in all inverters. For supporting three-phase system, make sure the sharing cables are connected in the inverters in the same phase, and disconnected in the inverters in different phases. 4. If the problem remains, please contact your installer.
71	The firmware version of each inverter is not the same.	<ol style="list-style-type: none"> 1. Update all inverter firmware to the same version. 2. Check the version of each inverter via LCD setting and make sure the CPU versions are same. If not, please contact your instraller to provide the firmware to update. 3. After updating, if the problem still remains, please contact your installer.
72	The output current of each inverter is different.	<ol style="list-style-type: none"> 1. Check if sharing cables are connected well and restart the inverter. 2. If the problem remains, please contact your installer.
80	CAN data loss	<ol style="list-style-type: none"> 1. Check if communication cables are connected well and restart the inverter. 2. If the problem remains, please contact your installer.
81	Host data loss	
82	Synchronization data loss	
83	The battery voltage of each inverter is not the same.	<ol style="list-style-type: none"> 1. Make sure all inverters share same groups of batteries together. 2. Remove all loads and disconnect AC input and PV input. Then, check battery voltage of all inverters. If the values from all inverters are close, please check if all battery cables are the same length and same material type. Otherwise, please contact your installer to provide SOP to calibrate battery voltage of each inverter. 3. If the problem still remains, please contact your installer.
84	AC input voltage and frequency are detected different.	<ol style="list-style-type: none"> 1. Check the utility wiring connction and restart the inverter. 2. Make sure utility starts up at same time. If there are breakers installed between utility and inverters, please be sure all breakers can be turned on AC input at same time. 3. If the problem remains, please contact your installer.
85	AC output current unbalance	<ol style="list-style-type: none"> 1. Restart the inverter. 2. Remove some excessive loads and re-check load information from LCD of inverters. If the values are different, please check if AC input and output cables are in the same length and material type. 3. If the problem remains, please contact your installer.
86	AC output mode setting is different.	<ol style="list-style-type: none"> 1. Switch off the inverter and check LCD setting #28. 2. For parallel system in single phase, make sure no 3P1, 3P2 or 3P3 is set on #28. For upporting three-phase system, make sure no "PAL" is set on #28. 3. If the problem remains, please contact your installer.

Appendix II: BMS Communication Installation

1. Introduction

If connecting to lithium battery, it is recommended to purchase a custom-made RJ45 communication cable. Please check with your dealer or integrator for details.

This custom-made RJ45 communication cable delivers information and signal between lithium battery and the inverter. These information are listed below:

- Re-configure charging voltage, charging current and battery discharge cut-off voltage according to the lithium battery parameters.
- Have the inverter start or stop charging according to the status of lithium battery.

2. Lithium Battery Connection

Step 1. Use a custom-made RJ45 cable to connect inverter and Lithium battery.

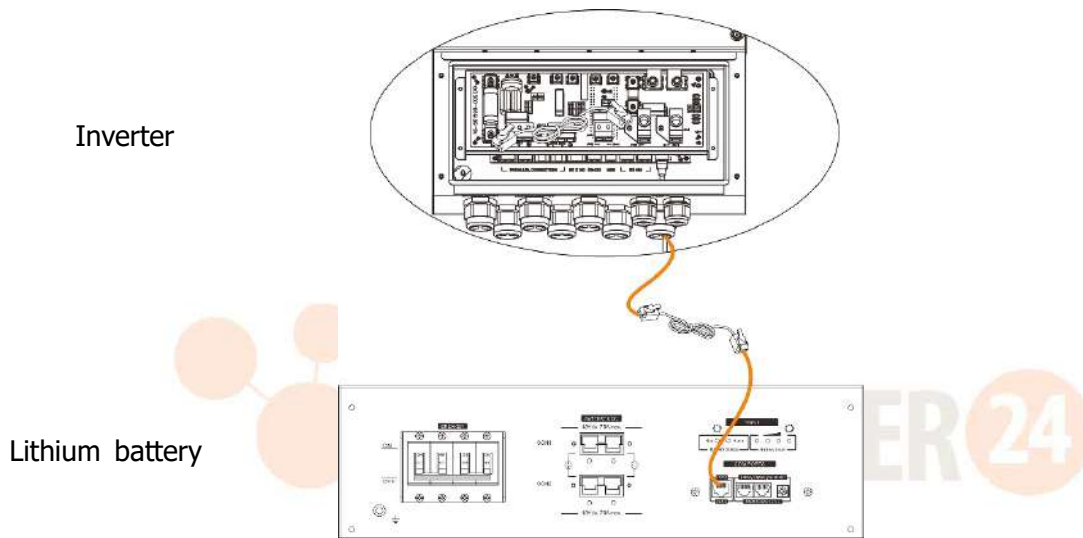

Please take notice for parallel system:

1. Only support common battery installation.
2. Use one custom-made RJ45 cable to connect any inverter (no need to connect to a specific inverter) and Lithium battery.

Step 2. Use supplied BMS-ready cable to connect either one of "Battery Capacity Extension" ports.

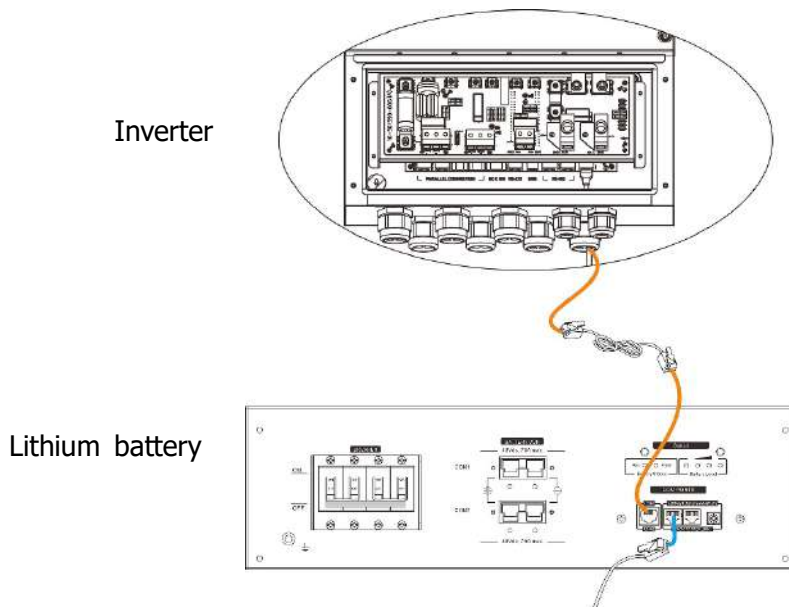

Step 3. If more than one battery, please be sure to set up each battery with unique ID. Then, use supplied RJ11 cable to connect first battery and second battery. Refer to chart below.

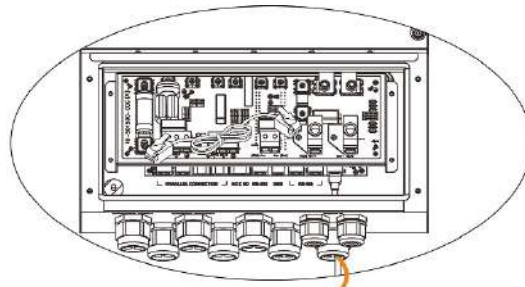

1st Lithium battery

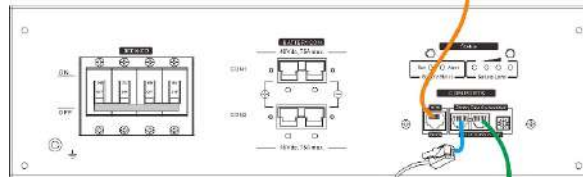

2nd Lithium battery

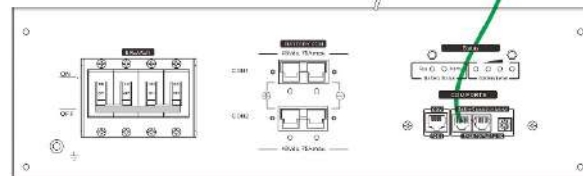

Step 4: Switch breaker to "ON" status on Lithium battery.

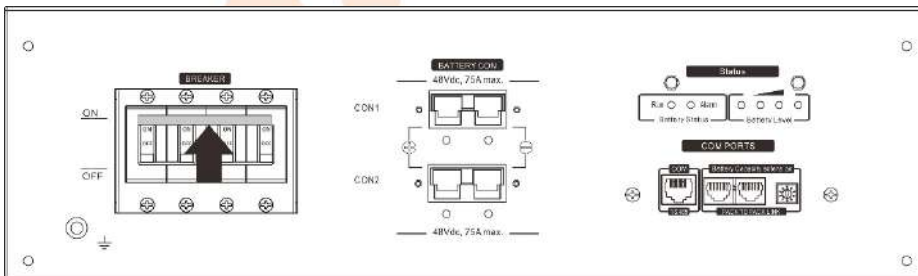

Step 5. Turn on the inverter.

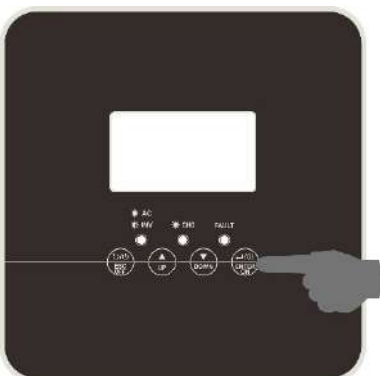

If communication between the inverter and battery is successful, the battery frame icon  on LCD display will "flash". Generally speaking, it will take longer than 1 minute to establish communication.

Appendix III: Approximate Back-up Time Table

Model	Load (VA)	Backup Time @ 48Vdc 100Ah (min)	Backup Time @ 48Vdc 200Ah (min)
2KW	200	1581	3161
	400	751	1581
	600	491	1054
	800	331	760
	1000	268	615
	1200	221	508
	1400	172	387
	1600	136	335
	1800	120	295
	2000	106	257
3KW	300	1054	2107
	600	491	1054
	900	291	688
	1200	196	497
	1500	159	402
	1800	123	301
	2100	105	253
	2400	91	219
	2700	71	174
	3000	63	155

Model	Load (VA)	Backup Time @ 48Vdc 200Ah (min)	Backup Time @ 48Vdc 400Ah (min)
5KW	500	1226	2576
	1000	536	1226
	1500	316	804
	2000	222	542
	2500	180	430
	3000	152	364
	3500	130	282
	4000	100	224
	4500	88	200
	5000	80	180

Note: Backup time depends on the quality of the battery, age of battery and type of battery. Specifications of batteries may vary depending on different manufacturers.