



---

# User Manual

## **SP24 INFINISOLAR V IV 6KW TWIN SOLAR INVERTER / CHARGER**



---

# Table Of Contents

<b>ABOUT THIS MANUAL .....</b>	<b>2</b>
Purpose.....	2
Scope .....	2
<b>SAFETY INSTRUCTIONS.....</b>	<b>2</b>
<b>INTRODUCTION .....</b>	<b>3</b>
Product Overview.....	4
<b>INSTALLATION .....</b>	<b>5</b>
Unpacking and Inspection .....	5
Preparation .....	5
Mounting the Unit.....	5
Battery Connection .....	6
AC Input/Output Connection.....	7
PV Connection .....	8
Final Assembly.....	9
Communication Connection.....	11
Dry Contact Signal.....	11
<b>OPERATION.....</b>	<b>12</b>
Power ON/OFF .....	12
Operation and Display Panel .....	12
LCD Display Icons .....	13
LCD Setting.....	16
Display Setting .....	28
Operating Mode Description .....	32
<b>CLEARANCE AND MAINTENANCE FOR ANTI-DUST KIT.....</b>	<b>38</b>
Overview .....	38
Clearance and Maintenance.....	38
<b>SPECIFICATIONS .....</b>	<b>39</b>
<b>TROUBLE SHOOTING .....</b>	<b>40</b>
<b>Appendix I: Parallel function .....</b>	<b>41</b>
<b>Appendix II: BMS Communication Installation.....</b>	<b>59</b>



## ABOUT THIS MANUAL

### Purpose

This manual describes the assembly, installation, operation and troubleshooting of this unit. Please read this manual carefully before installations and operations. Keep this manual for future reference.

### Scope

This manual provides safety and installation guidelines as well as information on tools and wiring.

## SAFETY INSTRUCTIONS



**WARNING: This chapter contains important safety and operating instructions. Read and keep this manual for future reference.**

1. Before using the unit, read all instructions and cautionary markings on the unit, the batteries and all appropriate sections of this manual.
2. **CAUTION** --To reduce risk of injury, charge only deep-cycle lead acid type rechargeable batteries. Other types of batteries may burst, causing personal injury and damage.
3. Do not disassemble the unit. Take it to a qualified service center when service or repair is required. Incorrect re-assembly may result in a risk of electric shock or fire.
4. To reduce risk of electric shock, disconnect all wirings before attempting any maintenance or cleaning. Turning off the unit will not reduce this risk.
5. **CAUTION** – Only qualified personnel can install this device with battery.
6. **NEVER** charge a frozen battery.
7. For optimum operation of this inverter/charger, please follow required spec to select appropriate cable size. It's very important to correctly operate this inverter/charger.
8. Be very cautious when working with metal tools on or around batteries. A potential risk exists to drop a tool to spark or short circuit batteries or other electrical parts and could cause an explosion.
9. Please strictly follow installation procedure when you want to disconnect AC or DC terminals. Please refer to INSTALLATION section of this manual for the details.
10. Fuses are provided as over-current protection for the battery supply.
11. GROUNDING INSTRUCTIONS -This inverter/charger should be connected to a permanent grounded wiring system. Be sure to comply with local requirements and regulation to install this inverter.
12. NEVER cause AC output and DC input short circuited. Do NOT connect to the mains when DC input short circuits.
13. **Warning!!** Only qualified service persons are able to service this device. If errors still persist after following troubleshooting table, please send this inverter/charger back to local dealer or service center for maintenance.
14. **ATTENTION IN CASE OF MALFUNCTION OF THE PRODUCT PLEASE CONTACT US BY EMAIL AT [assistenza@solarpower24.it](mailto:assistenza@solarpower24.it) WITH THE SERIAL NUMBER OF PRODUCT, EXACT MODEL, DEFECT FOUND AND YOU WILL BE CONTACTED. PLEASE NOTE THAT THE PRODUCT MUST NOT BE OPENED IN ANY WAY AND THAT OPENING WITH THE CONSEQUENT BREAKING OF THE WARRANTY SEAL VOIDS WARRANTY ON THE PRODUCT.**

## INTRODUCTION

This hybrid PV inverter can provide power to connected loads by utilizing PV power, utility power and battery power.

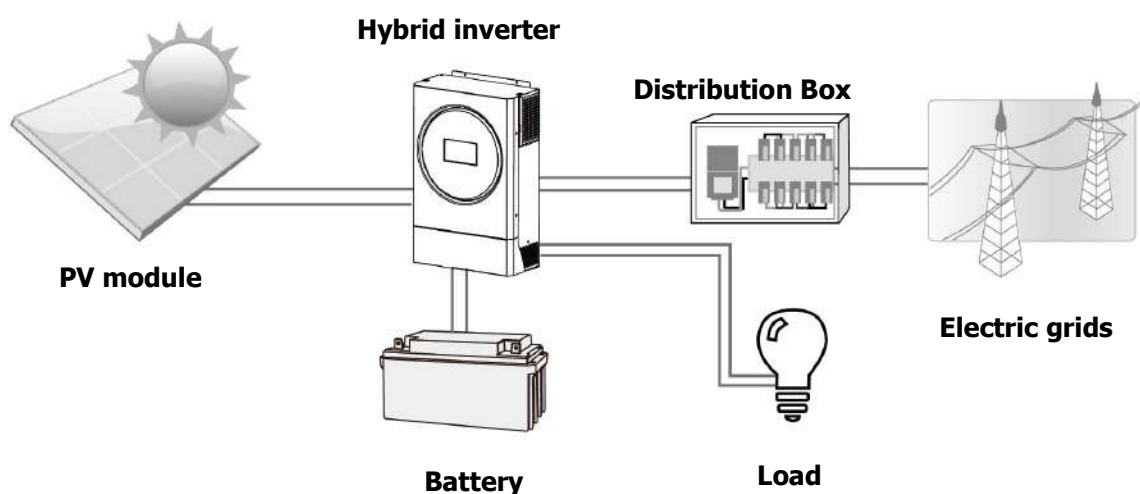

**Figure 1 Basic hybrid PV System Overview**

Depending on different power situations, this hybrid inverter is designed to generate continuous power from PV solar modules (solar panels), battery, and the utility. When MPP input voltage of PV modules is within acceptable range (see specification for the details), this inverter is able to generate power to feed the grid (utility) and charge battery. **Never connect the positive and negative terminals of the solar panel to the ground.** See Figure 1 for a simple diagram of a typical solar system with this hybrid inverter.

## Product Overview

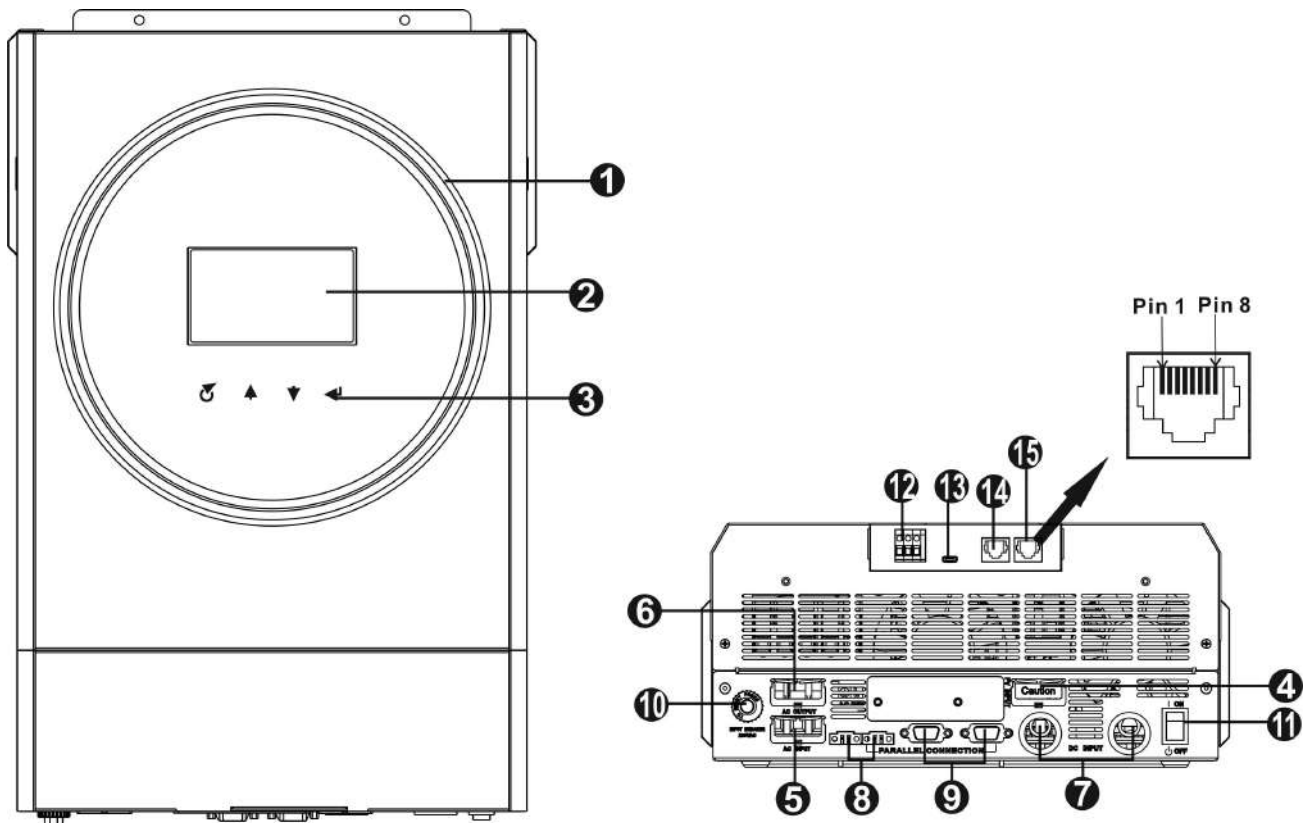

**NOTE:** For parallel installation and operation, please check *Appendix I*.

1. RGB LED ring (refer to LCD Setting section for the details)
2. LCD display
3. Function buttons
4. PV connectors
5. AC input connectors
6. AC output connectors (Load connection)
7. Battery connectors
8. Current sharing port
9. Parallel communication port
10. Circuit breaker
11. Power switch
12. Dry contact
13. USB port as USB communication port and USB function port
14. RS-232 communication port
15. BMS communication port: CAN, RS-485 or RS-232

## INSTALLATION

### Unpacking and Inspection

Before installation, please inspect the unit. Be sure that nothing inside the package is damaged. You should have received the following items inside of package:

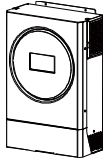

Inverter



CD



User manual



Communication cable

### Preparation

Before connecting all wirings, please take off bottom cover by removing two screws as shown below.

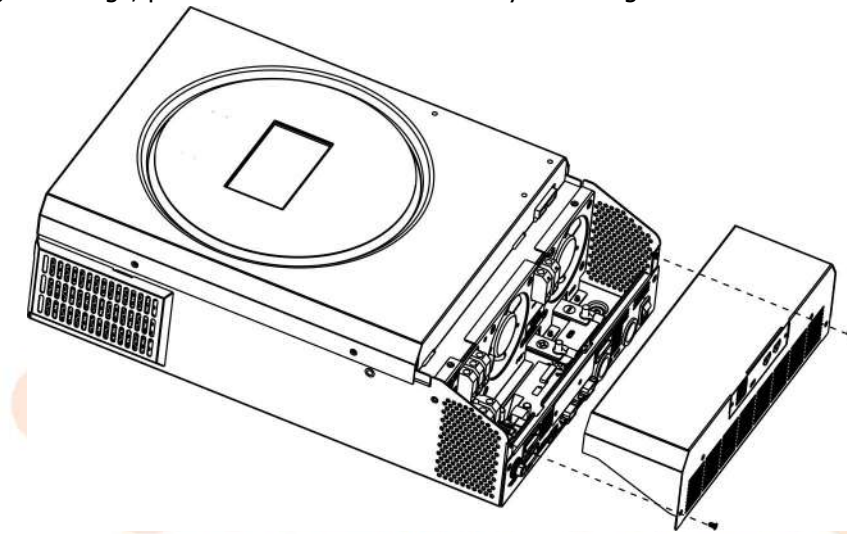

### Mounting the Unit

Consider the following points before selecting where to install:

- Do not mount the inverter on flammable construction materials.
- Mount on a solid surface.
- Install this inverter at eye level in order to allow the LCD display to be read at all times.
- The ambient temperature should be between  $-10^{\circ}\text{C}$  and  $50^{\circ}\text{C}$  to ensure optimal operation.
- The recommended installation position is to be adhered to the wall vertically.
- Be sure to keep other objects and surfaces as shown in the right diagram to guarantee sufficient heat dissipation and to have enough space for removing wires.

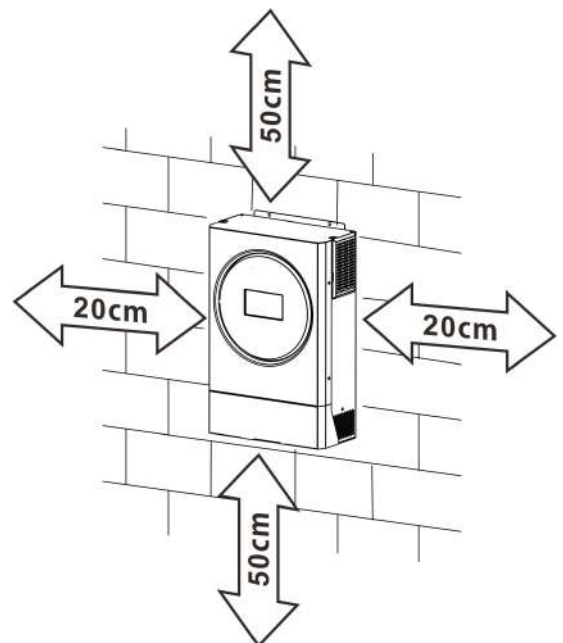

**SUITABLE FOR MOUNTING ON CONCRETE OR OTHER NON-COMBUSTIBLE SURFACE ONLY.**

Install the unit by screwing three screws. It's recommended to use M4 or M5 screws.

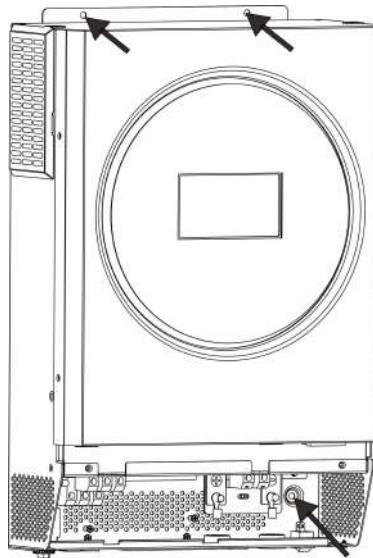

## Battery Connection

**CAUTION:** For safety operation and regulation compliance, it's requested to install a separate DC over-current protector or disconnect device between battery and inverter. It may not be requested to have a disconnect device in some applications, however, it's still requested to have over-current protection installed. Please refer to typical amperage in below table as required fuse or breaker size.

**WARNING!** All wiring must be performed by a qualified personnel.

**WARNING!** It's very important for system safety and efficient operation to use appropriate cable for battery connection. To reduce risk of injury, please use the proper recommended cable and terminal size as below.

**Ring terminal:**

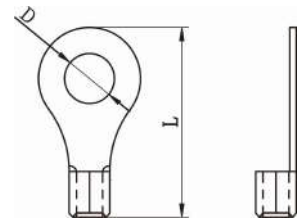

**Recommended battery cable and terminal size:**

Model	Typical Amperage	Battery Capacity	Wire Size	Ring Terminal			Torque Value
				Cable mm <sup>2</sup>	Dimensions		
					D (mm)	L (mm)	
6KW TWIN	137A	200AH	1*2AWG or 2*6AWG	28	6.4	42.7	2~3 Nm

Please follow below steps to implement battery connection:

1. Assemble battery ring terminal based on recommended battery cable and terminal size.
2. Insert the ring terminal of battery cable flatly into battery connector of inverter and make sure the nuts are tightened with torque of 2-3 Nm. Make sure polarity at both the battery and the inverter/charge is correctly connected and ring terminals are tightly screwed to the battery terminals.

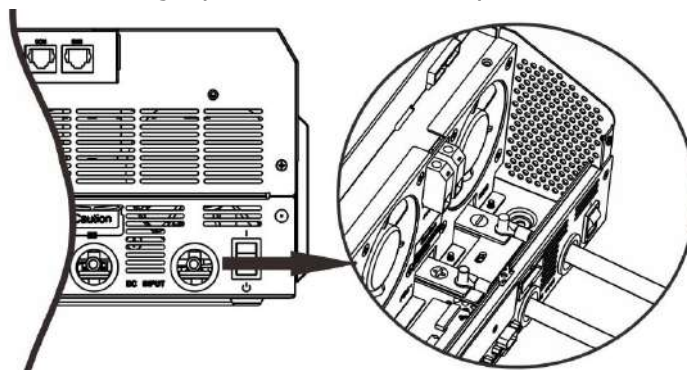





**WARNING: Shock Hazard**

Installation must be performed with care due to high battery voltage in series.



**CAUTION!!** Do not place anything between the flat part of the inverter terminal and the ring terminal. Otherwise, overheating may occur.

**CAUTION!!** Do not apply anti-oxidant substance on the terminals before terminals are connected tightly.

**CAUTION!!** Before making the final DC connection or closing DC breaker/disconnector, be sure positive (+) must be connected to positive (+) and negative (-) must be connected to negative (-).

## AC Input/Output Connection

**CAUTION!!** Before connecting to AC input power source, please install a **separate** AC breaker between inverter and AC input power source. This will ensure the inverter can be securely disconnected during maintenance and fully protected from over current of AC input.

**CAUTION!!** There are two terminal blocks with "IN" and "OUT" markings. Please do NOT mis-connect input and output connectors.

**WARNING!** All wiring must be performed by a qualified personnel.

**WARNING!** It's very important for system safety and efficient operation to use appropriate cable for AC input connection. To reduce risk of injury, please use the proper recommended cable size as below.

### Suggested cable requirement for AC wires

Model	Gauge	Torque Value
6KW TWIN	10 AWG	1.2~ 1.6 Nm

Please follow below steps to implement AC input/output connection:

1. Before making AC input/output connection, be sure to open DC protector or disconnector first.
2. Remove insulation sleeve 10mm for eight conductors. And shorten phase L and neutral conductor 3 mm.
3. Insert AC input wires according to polarities indicated on terminal block and tighten the terminal screws. Be sure to connect PE protective conductor (⊕) first.

⊕ → **Ground (yellow-green)**

L → **LINE (brown or black)**

N → **Neutral (blue)**

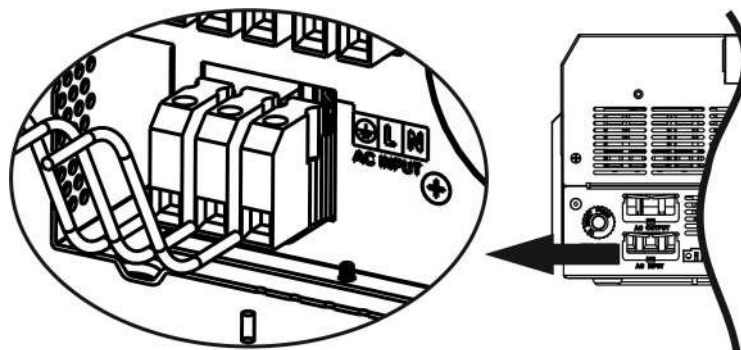

**WARNING:**

Be sure that AC power source is disconnected before attempting to hardwire it to the unit.

4. Then, insert AC output wires according to polarities indicated on terminal block and tighten terminal screws.

Be sure to connect PE protective conductor (⊕) first.

⊕ → **Ground (yellow-green)**

**L1** → **LINE (brown or black)**

**N1** → **Neutral (blue)**

**L2** → **LINE (brown or black)**

**N2** → **Neutral (blue)**

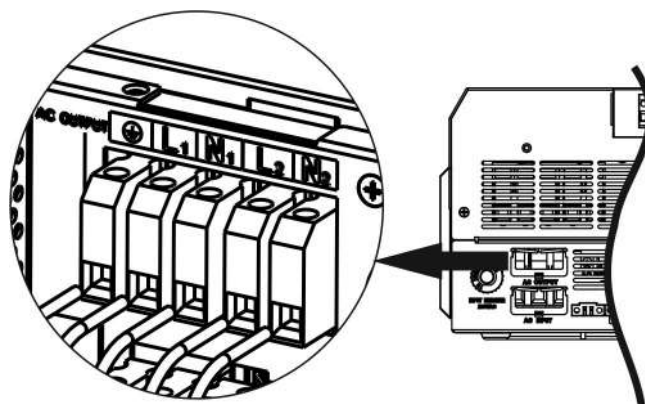

5. Make sure the wires are securely connected.

**CAUTION: Important**

Be sure to connect AC wires with correct polarity. If L and N wires are connected reversely, it may cause utility short-circuited when these inverters are worked in parallel operation.

**CAUTION:** Appliances such as air conditioner are required at least 2~3 minutes to restart because it's required to have enough time to balance refrigerant gas inside of circuits. If a power shortage occurs and recovers in a short time, it will cause damage to your connected appliances. To prevent this kind of damage, please check manufacturer of air conditioner if it's equipped with time-delay function before installation. Otherwise, this inverter/charger will trig overload fault and cut off output to protect your appliance but sometimes it still causes internal damage to the air conditioner.

## PV Connection

**CAUTION:** Before connecting to PV modules, please install **separately** a DC circuit breaker between inverter and PV modules.

**WARNING!** All wiring must be performed by a qualified personnel.

**WARNING:** Please switch off the inverter before you connect PV modules. Otherwise, it will damage the inverter.

**WARNING!** It's very important for system safety and efficient operation to use appropriate cable for PV module connection. To reduce risk of injury, please use the proper recommended cable size as below.

Model	Typical Amperage	Cable Size	Torque
6KW TWIN	27A	10AWG	2.0~2.4Nm

### PV Module Selection:

When selecting proper PV modules, please be sure to consider below parameters:

1. Open circuit Voltage (Voc) of PV modules not exceeds max. PV array open circuit voltage of inverter.
2. Open circuit Voltage (Voc) of PV modules should be higher than min. battery voltage.

Solar Charging Mode	
INVERTER MODEL	6KW TWIN
Max. PV Array Open Circuit Voltage	500 Vdc
PV Array MPPT Voltage Range	120~430Vdc
MPP Number	1

Please follow below steps to implement PV module connection:

1. Remove insulation sleeve 10 mm for positive and negative conductors.
2. Check correct polarity of connection cable from PV modules and PV input connectors. Then, connect positive pole (+) of connection cable to positive pole (+) of PV input connector. Connect negative pole (-) of connection cable to negative pole (-) of PV input connector.

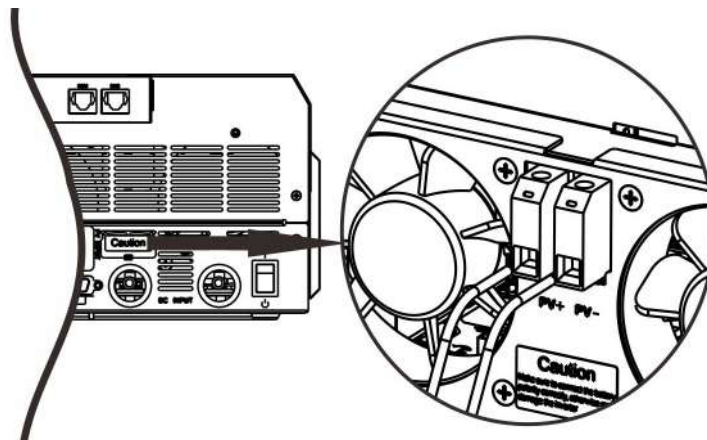
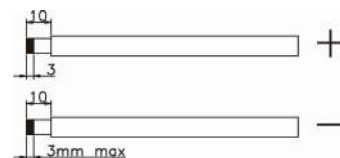

### Recommended PV module Configuration

PV Module Spec. (reference)	Total solar input power	Solar input	Q'ty of modules
- 250Wp - Vmp: 30.7Vdc - Imp: 8.15A - Voc: 37.4Vdc - Isc: 8.63A - Cells: 60	1500W	6 pieces in series	6 pcs
	2000W	8 pieces in series	8 pcs
	2750W	11 pieces in series	11 pcs
	3000W	6 pieces in series 2 strings in parallel	12 pcs
	4000W	8 pieces in series 2 strings in parallel	16 pcs
	5000W	10 pieces in series 2 strings in parallel	20 pcs
	6000W	12 pieces in series 2 strings in parallel	24 pcs

### Final Assembly

After connecting all wirings, please put bottom cover back by screwing two screws as shown below.

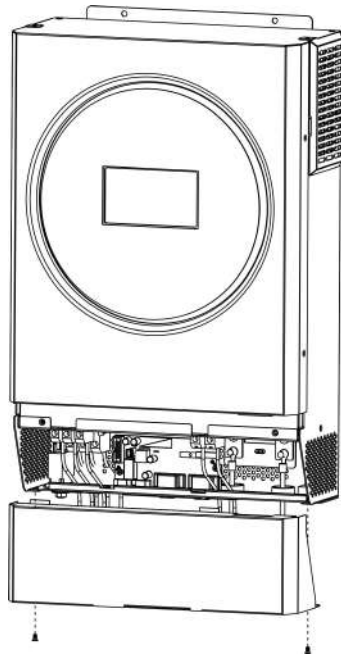

## Communication Connection

### Serial Connection

Please use supplied communication cable to connect to inverter and PC. Insert bundled CD into a computer and follow on-screen instruction to install the monitoring software. For the detailed software operation, please check user manual of software inside of CD.

### Wi-Fi Connection

Wi-Fi module can enable wireless communication between off-grid inverters and monitoring platform. Users have complete and remote monitoring and controlling experience for inverters when combining Wi-Fi module with SolarPower APP, available for both iOS and Android based device. All data loggers and parameters are saved in iCloud. For quick installation and operation, please refer to Appendix III - The Wi-Fi Operation Guide for details.



## Dry Contact Signal

There is one dry contact (3A/250VAC) available on the rear panel. It could be used to deliver signal to external device when battery voltage reaches warning level.

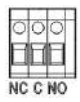
Unit Status	Condition		Dry contact port: 		
			NC & C	NO & C	
Power Off	Unit is off and no output is powered.		Close	Open	
Power On	Output is powered from Utility.		Close	Open	
	Output is powered from Battery or Solar.	Program 01 set as SUB	Battery voltage < Low DC warning voltage	Open	Close
			Battery voltage > Setting value in Program 21 or battery charging reaches floating stage	Close	Open
	Output is powered from Battery or Solar.	Program 01 is set as SBU	Battery voltage < Setting value in Program 20	Open	Close
Battery voltage > Setting value in Program 21 or battery charging reaches floating stage			Close	Open	

## OPERATION

### Power ON/OFF

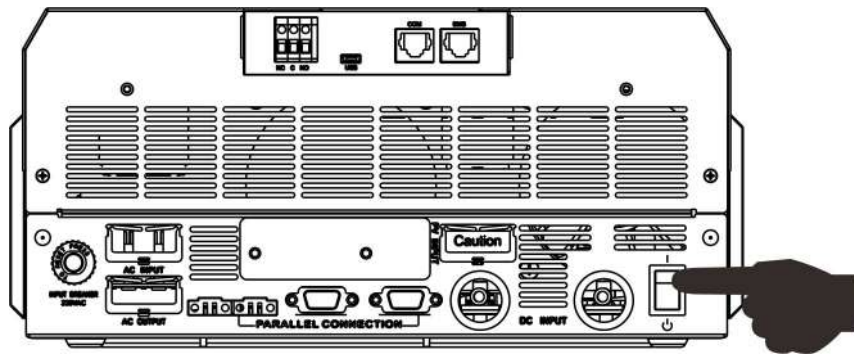

Once the unit has been properly installed and the batteries are connected well, simply press On/Off switch to turn on the unit.

### Operation and Display Panel

The operation and display panel, shown in below chart, is on the front panel of the inverter. It includes one RGB LED ring, four touchable function keys and a LCD display, indicating the operating status and input/output power information.

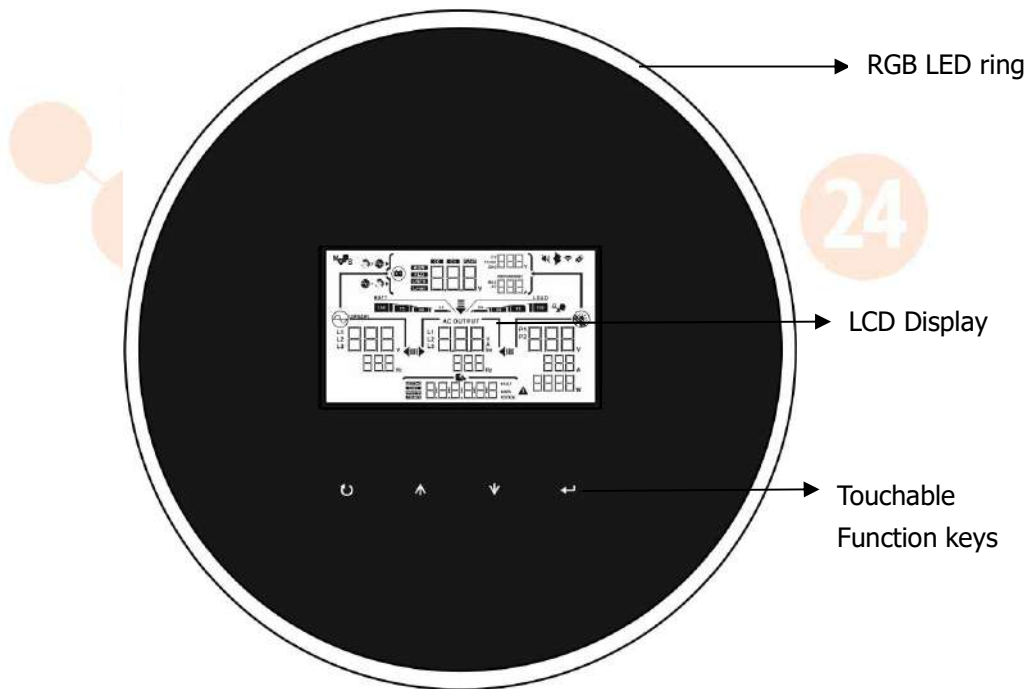

#### Touchable Function Keys

Function Key	Description	
	ESC	To exit the setting
	USB function selector	To enter USB function setting
	Up	To last selection
	Down	To next selection
	Enter	To confirm/enter the selection in setting mode

# LCD Display Icons

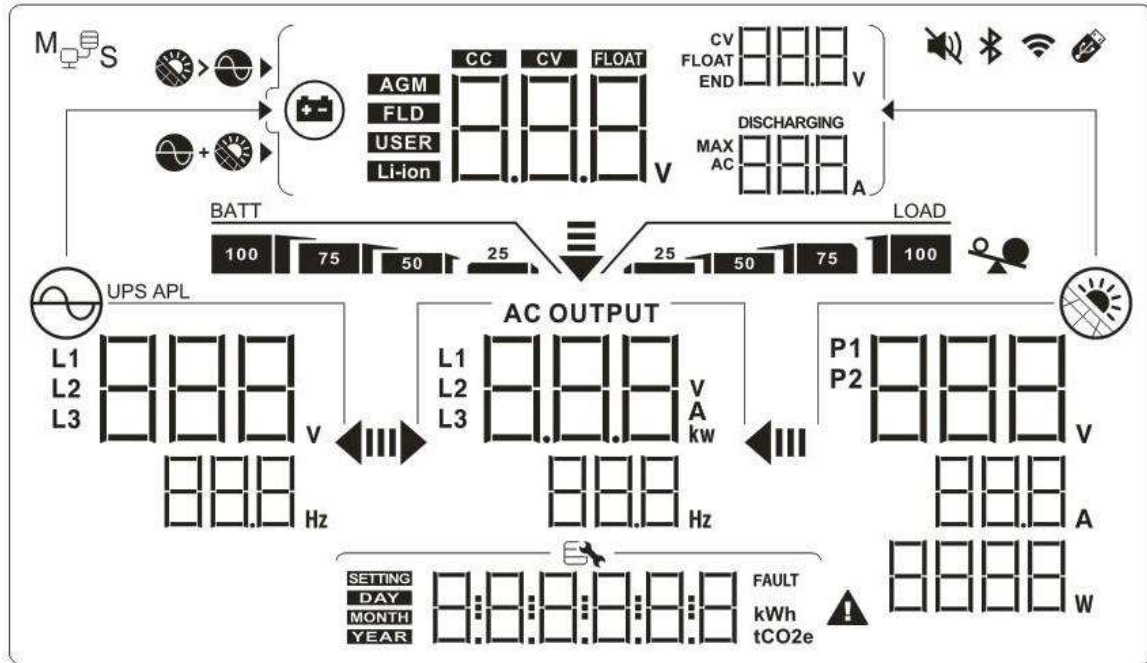

Icon	Function description
<b>Input Source Information</b>	
	Indicates the AC input voltage and frequency.
	Indicates the PV voltage, current and power.
	Indicates the battery voltage, charging stage, configured battery parameters, charging or discharging current.
<b>Configuration Program and Fault Information</b>	
	Indicates the setting programs.
	Indicates the warning and fault codes. Warning:  flashing with warning code. Fault:  lighting with fault code.
<b>Output Information</b>	

	<p>Indicate the output voltage, load in VA, load in Watt and output frequency.</p>
--	--

**Battery Information**

	<p>Indicates battery level in battery mode and charging status in line mode by 0-24%, 25-49%, 50-74% and 75-100%.</p>
--	---

When battery is charging, it will present battery charging status.

Status	Battery voltage	LCD Display
Constant Current mode / Constant Voltage mode	<2V/cell	4 bars will flash in turns.
	2 ~ 2.083V/cell	The right bar will be on and the other three bars will flash in turns.
	2.083 ~ 2.167V/cell	The right two bars will be on and the other two bars will flash in turns.
Floating mode. Batteries are fully charged.		4 bars will be on.

In battery mode, it will present battery capacity.

Load Percentage	Battery Voltage	LCD Display
Load > 50%	< 1.85V/cell	
	1.85V/cell ~ 1.933V/cell	
	1.933V/cell ~ 2.017V/cell	
	> 2.017V/cell	
Load < 50%	< 1.892V/cell	
	1.892V/cell ~ 1.975V/cell	
	1.975V/cell ~ 2.058V/cell	
	> 2.058V/cell	

**Load Information**

	<p>Indicates overload.</p>									
	<p>Indicates the load level by 0-24%, 25-49%, 50-74% and 75-100%.</p> <table border="1" style="width:100%; text-align:center;"> <tr> <td>0%~24%</td> <td>25%~49%</td> </tr> <tr> <td></td> <td></td> </tr> <tr> <td>50%~74%</td> <td>75%~100%</td> </tr> <tr> <td></td> <td></td> </tr> </table>		0%~24%	25%~49%			50%~74%	75%~100%		
0%~24%	25%~49%									
50%~74%	75%~100%									

**Charger Source Priority Setting Display**

	<p>Indicates setting program 10 "Charger source priority" is selected as "Solar first".</p>
	<p>Indicates setting program 10 "Charger source priority" is selected as "Solar and Utility".</p>
	<p>Indicates setting program 10 "Charger source priority" is selected as "Solar only".</p>







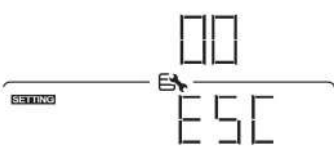
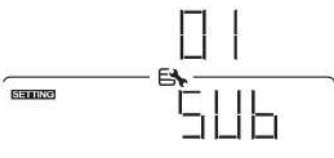
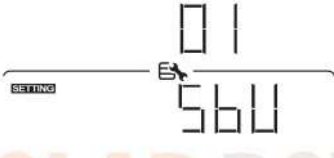
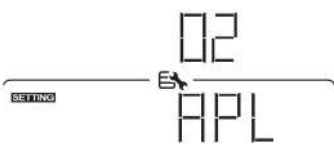
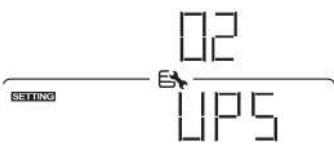
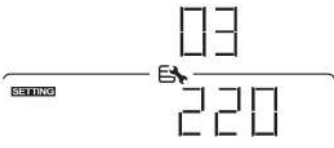
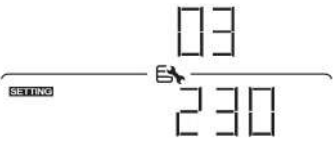

Output source priority setting display	
	Indicates setting program 01 "Output source priority" is selected as "SUB".
	Indicates setting program 01 "Output source priority" is selected as "SBU".
AC Input Voltage Range Setting Display	
UPS	Indicates setting program 02 is selected as "UPS". The acceptable AC input voltage range will be within 170-280VAC.
APL	Indicates setting program 02 is selected as "APL". The acceptable AC input voltage range will be within 90-280VAC.
Operation Status Information	
	Indicates unit connects to the mains.
	Indicates unit connects to the PV panel.
<div style="display: flex; flex-direction: column; gap: 5px;"> <div style="border: 1px solid black; padding: 2px;">AGM</div> <div style="border: 1px solid black; padding: 2px;">FLD</div> <div style="border: 1px solid black; padding: 2px;">USER</div> <div style="border: 1px solid black; padding: 2px;">Li-ion</div> </div>	Indicates battery type.
	Indicates parallel operation is working.
	Indicates unit alarm is disabled.
	Indicates Wi-Fi transmission is working.
	Indicates USB disk is connected.

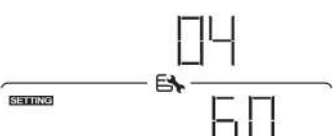
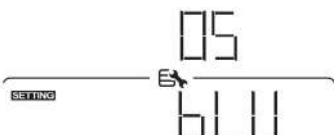
## LCD Setting



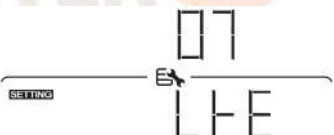
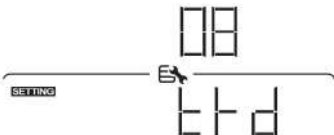
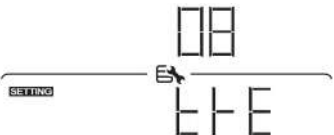
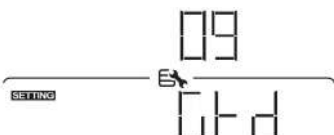



After pressing and holding ENTER button for 3 seconds, the unit will enter setting mode. Press "UP" or "DOWN" button to select setting programs. And then, press "ENTER" button to confirm the selection or ESC button to exit.

Program	Description	Selectable option	
00	Exit setting mode	Escape 	
01	Output source priority selection	SUB(default) 	Solar energy provides power to the loads as first priority. If solar energy is not sufficient to power all connected loads, Utility energy will supply power to the loads at the same time.
		SBU 	Solar energy provides power to the loads as first priority. If solar energy is not sufficient to power all connected loads, battery energy will supply power to the loads at the same time. Utility provides power to the loads only when battery voltage drops to either low-level warning voltage or the setting point in program 20 or solar and battery is not sufficient.
02	AC input voltage range	Appliances (default) 	If selected, acceptable AC input voltage range will be within 90-280VAC.
		UPS 	If selected, acceptable AC input voltage range will be within 170-280VAC.
03	Output voltage	220Vac 	230V (Default) 

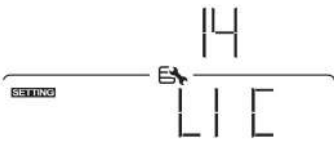
		240Vac 	
04	Output frequency	50Hz (default) 	60Hz 
05	Solar supply priority	Charge battery first (default) 	Solar energy provides power to charge battery as first priority.
		Power the loads first 	Solar energy provides power to the loads as first priority.
06	Overload bypass: When enabled, the unit will transfer to line mode if overload occurs in battery mode.	Bypass disable 	Bypass enable (default) 
07	Auto restart when overload occurs	Restart disable (default) 	Restart enable 
08	Auto restart when over temperature occurs	Restart disable (default) 	Restart enable 
09	Solar energy feed to grid configuration	Feed to grid disable (default) 	If selected, solar energy is not allowed to feed to the grid.
		Feed to grid enable 	If selected, solar energy is allowed to feed to the grid.

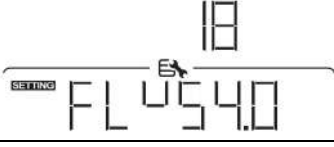
10	Charger source priority: To configure charger source priority	If this inverter/charger is working in Line, Standby or Fault mode, charger source can be programmed as below:	
		Solar first 	Solar energy will charge battery as first priority. Utility will charge battery only when solar energy is not available.
		Solar and Utility (default) 	Solar energy and utility will charge battery at the same time.
		Only Solar 	Solar energy will be the only charger source no matter utility is available or not.
11	Maximum charging current: To configure total charging current for solar and utility chargers. (Max. charging current = utility charging current + solar charging current)	60A (default) 	The setting range is from 10A to 120A. Increment of each click is 10A.
13	Maximum utility charging current	2A 	10A 
		20A 	30A (default) 
		40A 	50A 
		60A 	70A 

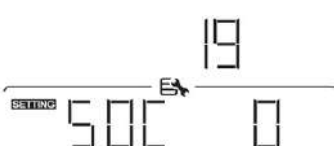
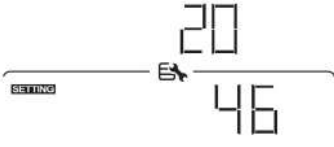
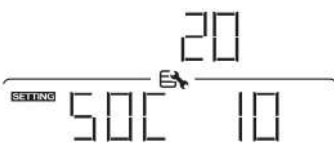
		80A 	90A 
		100A 	110A 
		120A 	
14	Battery type	AGM (default) 	Flooded 
		User-Defined 	If "User-Defined" is selected, battery charge voltage and low DC cut-off voltage can be set up in program 17, 18 and 19.
		Pylontech battery 	If selected, programs of 11, 17, 18 and 19 will be automatically set up. No need for further setting.
		WECO battery 	If selected, programs of 11, 17, 18, 19 and 20 will be auto-configured per battery supplier recommended. No need for further adjustment. Programs of 20 and 21 parameters refer to SOC of battery.
		Soltaro battery 	If selected, programs of 11, 17, 18 and 19 will be automatically set up. No need for further setting.
		LIb-protocol compatible battery 	Select "LIb" if using Lithium battery compatible to Lib protocol. If selected, programs of 11, 17, 18 and 19 will be automatically set up. No need for further setting.

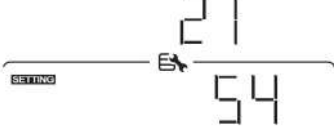
		3 <sup>rd</sup> party Lithium battery 	If selected, programs of 02, 26, 27 and 29 will be automatically set up. No need for further setting. Please contact the battery supplier for installation procedure.
17	Bulk charging voltage (C.V voltage)	Default setting: 56.4V 	If self-defined is selected in program 14, this program can be set up. Setting range is from 48.0V to 64.0V. Increment of each click is 0.1V.
18	Floating charging voltage	Default setting: 54.0V 	If self-defined is selected in program 14, this program can be set up. Setting range is from 48.0V to 64.0V. Increment of each click is 0.1V.
19	Low DC cut off battery voltage setting	Default setting: 40.8V 	If self-defined is selected in program 14, this program can be set up. Setting range is from 40.8V to 48.0V. Increment of each click is 0.1V. Low DC cut-off voltage will be fixed to setting value no matter what percentage of load is connected.
		SOC 0% (default) 	If any type of lithium battery is selected in program 14, this program can be set up. Setting range is from 0% to 80%
20	Battery stop discharging voltage when grid is available	default setting: 46V 	Setting range is from 44V to 51V and increment of each click is 1V.
		10% (default) 	If any type of lithium battery is selected in program 14, this setting will change to SOC automatically. Adjustable range is from 5% to 95%.
21	Battery stop charging voltage when grid is available	Battery fully charged 	The setting range is FUL and then from 48V to 58V. Increment of each click is 1V.
		Default setting: 54V 	

		30% (default) 	If any lithium battery is selected in program 14, this parameter will refer to the SOC of battery and adjustable from 10% to 100%. Increment of each click is 5%.
22	Auto return to default display screen	Return to default display screen (default) 	If selected, no matter how users switch display screen, it will automatically return to default display screen (Input voltage /output voltage) after no button is pressed for 1 minute.
		Stay at latest screen 	If selected, the display screen will stay at latest screen user finally switches.
23	Backlight control	Backlight on (default) 	Backlight off 
		Alarm on (default) 	Alarm off 
25	Beeps while primary source is interrupted	Alarm on (default) 	Alarm off 
		Record enable 	Record disable (default) 
28	AC output mode *This setting is only available when the inverter is in standby mode (Switch off).	Single: This inverter is used in single phase application. 	Parallel: This inverter is operated in parallel system. 
		L1 phase 	The inverter is operated in L1 phase in 3-phase application.

		L2 phase 	The inverter is operated in L2 phase in 3-phase application.
		L3 phase 	The inverter is operated in L3 phase in 3-phase application.
29	Reset PV energy storage	Not reset(Default) 	Reset 
30	Start charging time for AC charger	00:00 (Default) 	The setting range of start charging time for AC charger is from 00:00 to 23:00, increment of each click is 1 hour.
31	Stop charging time for AC charger	00:00 (Default) 	The setting range of stop charging time for AC charger is from 00:00 to 23:00, increment of each click is 1 hour.
32	Scheduled time for AC output on	00:00 (Default) 	The setting range of scheduled Time for AC output on is from 00:00 to 23:00, increment of each click is 1 hour.
33	Scheduled time for AC output off	00:00(Default) 	The setting range of scheduled Time for AC output off is from 00:00 to 23:00, increment of each click is 1 hour.
34	Set country customized regulations	India(Default) 	If selected, acceptable feed-in grid voltage range will be 195.5~253VAC. Acceptable feed-in grid frequency range will be 49~51Hz.
		Germany 	If selected, acceptable feed-in grid voltage range will be 184~264.5VAC. Acceptable feed-in grid frequency range will be 47.5~51.5Hz.
		South America	If selected, acceptable feed-in grid voltage range will be 184~264.5VAC. Acceptable feed-in grid frequency

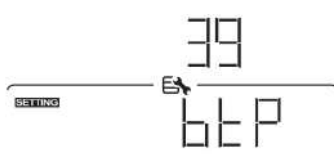
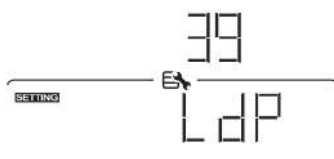
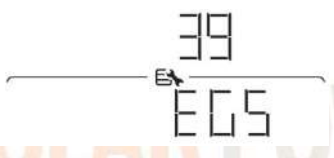
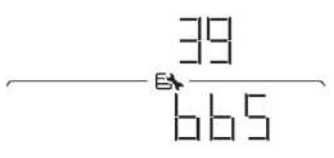
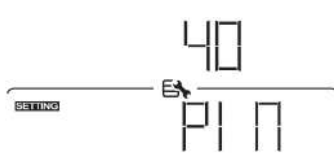
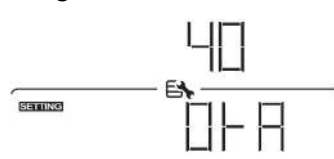
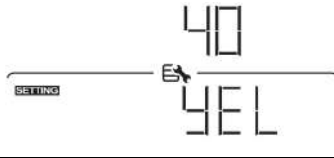
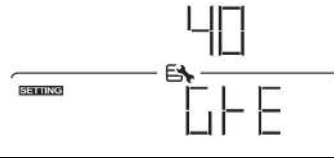
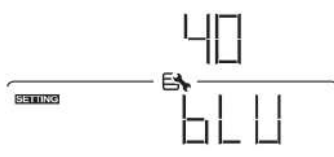
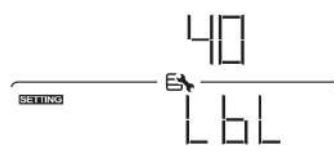

			range will be 57~62Hz.
35	<p>On/Off control for RGB LED</p> <p>*It's necessary to enable this setting to activate RGB LED lighting function.</p>	<p>Enabled (default)</p>	<p>Disable</p>
36	Brightness of RGB LED	<p>Low</p>	<p>Normal (default)</p>
		<p>High</p>	
37	Lighting speed of RGB LED	<p>Low</p>	<p>Normal (default)</p>
		<p>High</p>	
38	RGB LED effect	<p>Power cycling</p>	<p>Power wheel</p>
		<p>Power chasing</p>	<p>Solid on (Default)</p>
39	Data Presentation of data color	<p>Solar input power in watt</p>	<p>LED lighting portion will be changed by the percentage of solar input power and nominal PV power. If "Solid on" is selected in #38, LED ring will light up with background color setting in #40. If "Power wheel" is selected in #38, LED ring will light up in 4 levels.</p>

			If "cycling" or "chasing" is selected in #38, LED ring will light up in 12 levels.
39	Data Presentation of data color *Energy source (Grid-PV-Battery) and battery charge/discharge status only available when RGB LED effect is set to "Solid on".	Battery capacity percentage (Default) 	LED lighting portion will be changed by battery capacity percentage. If "Solid on" is selected in #38, LED ring will light up with background color setting in #40. If "Power wheel" is selected in #38, LED ring will light up in 4 levels. If "cycling" or "chasing" is selected in #38, LED ring will light up in 12 levels.
		Load percentage. 	LED lighting portion will be changed by load percentage. If "Solid on" is selected in #38, LED ring will light up with background color setting in #40. If "Power wheel" is selected in #38, LED ring will light up in 4 levels. If "cycling" or "chasing" is selected in #38, LED ring will light up in 12 levels.
		Energy source (Grid-PV-Battery) 	If selected, the LED color will be background color setting in #40 in AC mode. If PV power is active, the LED color will be data color setting in #41. If the remaining status, the LED color will be set in #42.
		Battery charge/discharge status 	If selected, the LED color will be background color setting in #40 in battery charging status. The LED color will be data color setting in #41 in battery discharging status.
40	Background color of RGB LED	Pink 	Orange 
		Yellow 	Green 
		Blue 	Sky blue 

40	Background color of RGB LED	Purple 	White (Default) 
		Other 	If "other" is selected, the background color is set by RGB via software.
41	Data Color for RGB LED	Pink 	Orange 
		Yellow 	Green 
		Blue 	Sky blue 
		Purple 	White (Default) 
		Other 	If "other" is selected, the data color is set by RGB via software.
42	Background color of RGB LED only available when data Presentation of data color is set to Energy source (Grid-PV-Battery).	Pink 	Orange 
		Yellow 	Green 

42	Background color of RGB LED only available when data Presentation of data color is set to Energy source (Grid-PV-Battery).	Blue 	Sky blue 
		Purple 	White (Default) 
		Other 	If "other" is selected, the background color is set by RGB via software.
60	Low DC cut off voltage on second output	Default setting: 40.8V 	Setting range is from 40.8V to 48.0V. Increment of each click is 0.1V. This low DC cut-off voltage will be fixed to setting value no matter what percentage of load is connected.
		0% (default) 	If any type of lithium battery is selected in program 14, this parameter value will be displayed in percentage and value setting is based on battery capacity percentage. Setting range is from 0% to 95%. Increment of each click is 5%.
61	Setting discharge time on the 2nd output	Disable (Default) 	Setting range is disable and then from 0 min to 990 min. Increment of each click is 5 min. *If the battery discharge time achieves the setting time in program 61 and the program 60 function is not triggered, the output will be turned off.
62	Scheduled time for 2nd AC output on	00:00 (Default) 	Setting range is from 00:00 to 23:00. Increment of each click is 1 hour. Within scheduled on/off time setting in program 62 and 63, 2nd AC output will be turn off based on the setting value in program 60 or 61.
63	Scheduled time for 2nd AC output off	00:00 (Default) 	Setting range is from 00:00 to 23:00. Increment of each click is 1 hour. Within scheduled on/off time setting in program 62 and 63, 2nd AC output will be turn off based on the setting value in program 60 or 61.

95	Time setting – Minute		For minute setting, the range is from 00 to 59.
96	Time setting – Hour		For hour setting, the range is from 00 to 23.
97	Time setting– Day		For day setting, the range is from 00 to 31.
98	Time setting– Month		For month setting, the range is from 01 to 12.
99	Time setting – Year		For year setting, the range is from 16 to 99.

## USB Function Setting

Follow below steps to upgrade firmware.

Procedure	LCD Screen
<b>Step 1:</b> Insert an USB disk into the USB port (N in product overview). Press and hold "↻" button for 3 seconds to enter USB Function Setting Mode. It will show "🔌" on the top right corner and "FDY" in LCD.	
<b>Step 2:</b> Press "←" button to read the file from the USB disk. If there is no burning file, the LCD will alert "U01". Otherwise it will enter the next step.	
<b>Step 3:</b> <ul style="list-style-type: none"> <li>● Press "▲" button choose "yes" to start the firmware upgrade.</li> <li>● Or press "↻" or "▼" button to return to main screen.</li> </ul>	
<b>Step 4:</b> If "yes" is select, it will start the firmware upgrade. The LCD will display "YES" and complete progress in percentage on the right. "88" represents 88% completion progress. Once 100% is complete, press "↻" button to return to main screen.	

If no button is pressed for 1 minute, it will automatically return to main screen.

## Error message for USB On-the-Go functions:

Error Code	Messages
U01	No USB disk is detected.
U02	USB disk is protected from copy.
U03	Document inside the USB disk with wrong format.

If any error occurs, error code will only show 3 seconds. After 3 seconds, it will automatically return to display screen.

## Display Setting

The LCD display information will be switched in turns by pressing “▲” or “▼” key. The selectable information is switched as the following table in order.

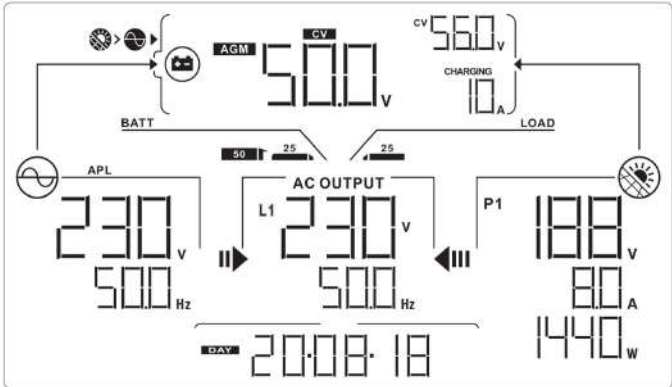
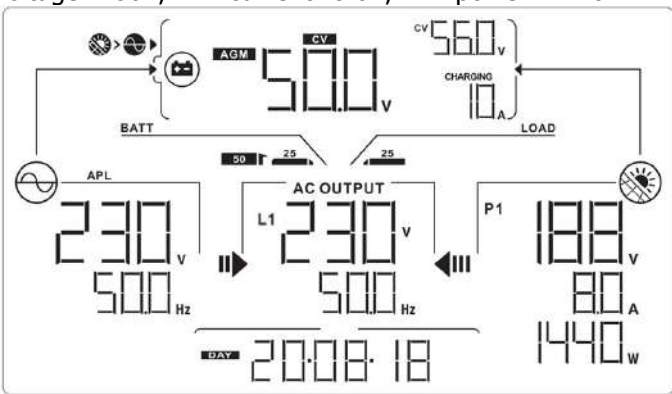
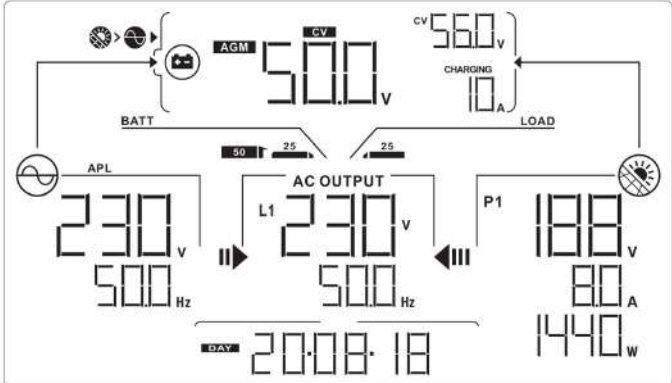
Selectable information	LCD display
Utility voltage/ Utility frequency	<p>Input Voltage=230V, Input frequency=50Hz</p> 
Default Display Screen	<p>PV1 voltage=180V, PV1 current=8.0A, PV1 power=1440W</p> 
Battery voltage, charging stage/ Configured battery parameters/ Charging or discharging current	<p>Battery voltage=50.0V, Bulk charging voltage=56.0V, Charging current=10A</p> 

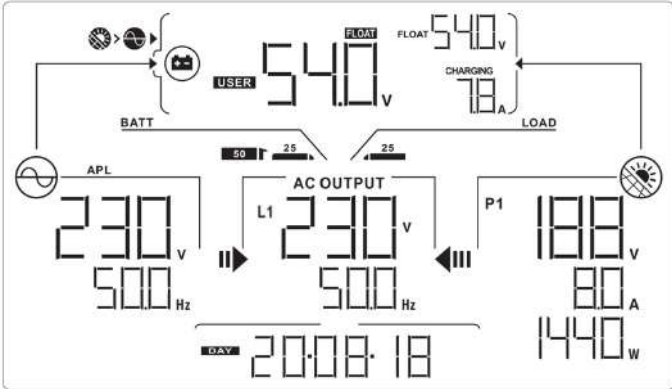
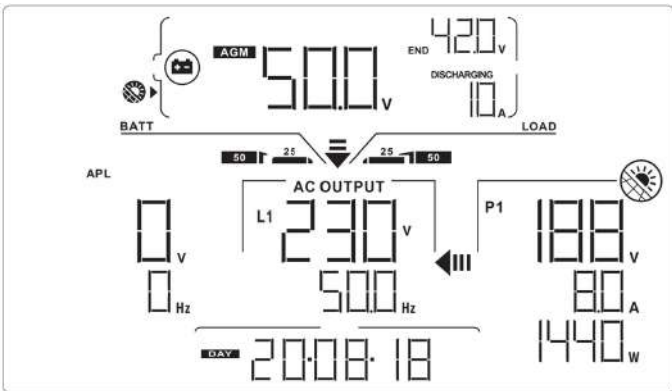
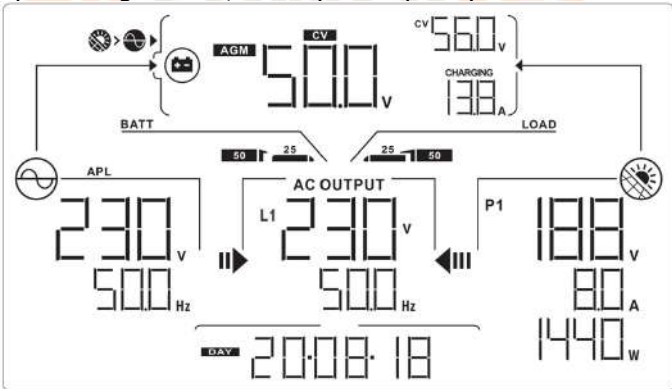
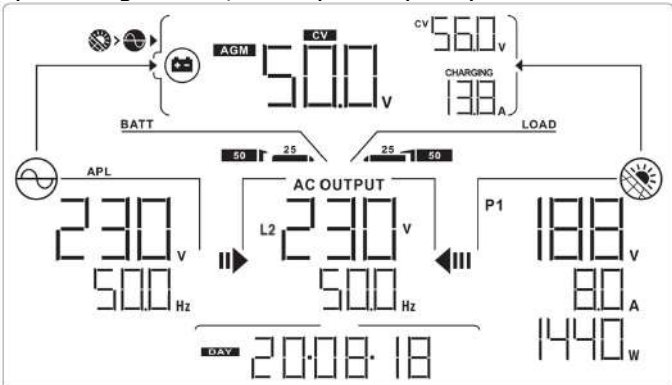
Selectable information	LCD display	LCD display
<p>Default Display Screen</p>	<p>Battery voltage, charging stage/ Configured battery parameters/ Charging or discharging current</p>	<p>Battery voltage=54.0V, Floating charging voltage=54.0V, Charging current=7.8A</p> 
		<p>Battery voltage=50.0V, Low DC cut-off voltage=42.0V, Discharging current=10A</p> 
<p>L1 output voltage/output frequency, L2 output voltage/output frequency, load in VA, load in Watt switch every 5 second</p>		<p>L1 output voltage=230V, L1 output frequency=50Hz</p> 
		<p>L2 output voltage=230V, L2 output frequency=50Hz</p> 

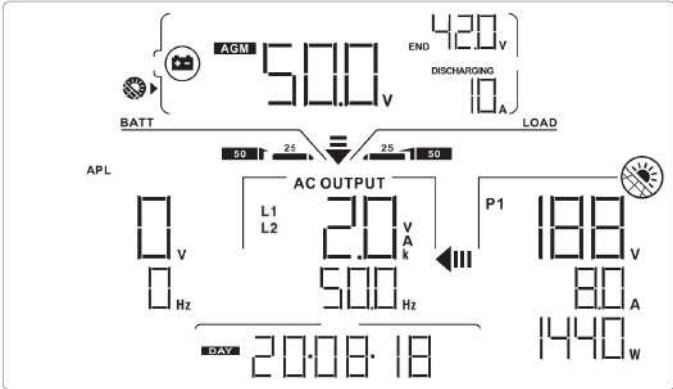
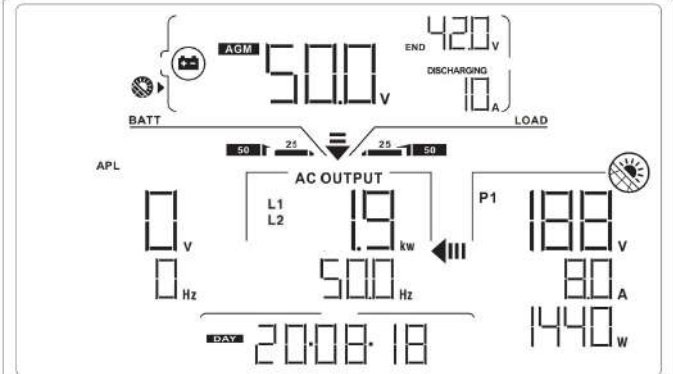
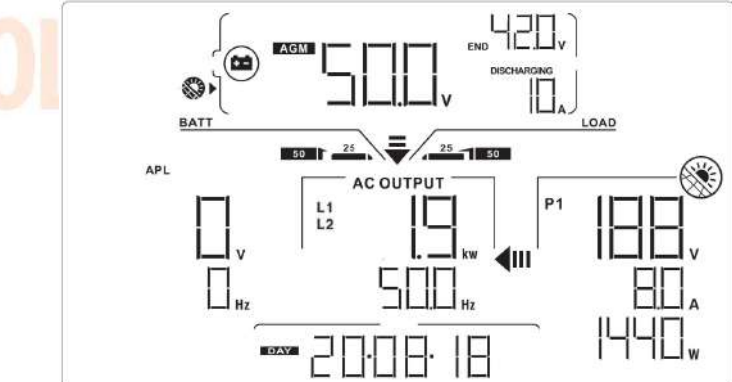
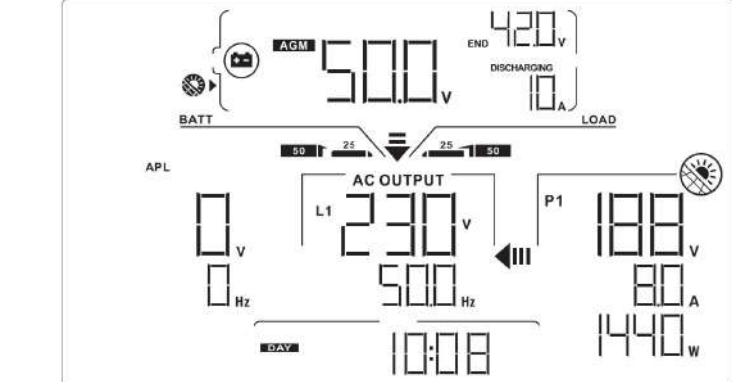
Selectable information	LCD display	LCD display
<p>Default Display Screen</p>	<p>L1 output voltage/output frequency, L2 output voltage/output frequency, load in VA, load in Watt switch every 5 second</p>	<p>Total load in VA=2.0KVA, L1 output frequency=50Hz</p> 
		<p>Total load in Watt=1.9KW, L1 output frequency=50Hz</p> 
<p>Real date.</p>	<p>Real date.</p>	<p>Real date 2020-08-18.</p> 
<p>Real time.</p>	<p>Real time.</p>	<p>Real time 10:08.</p> 

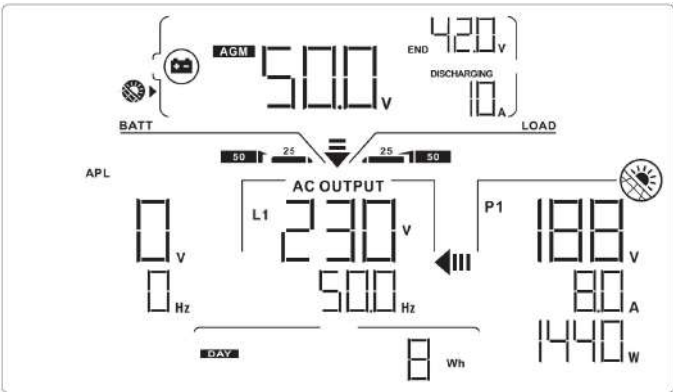
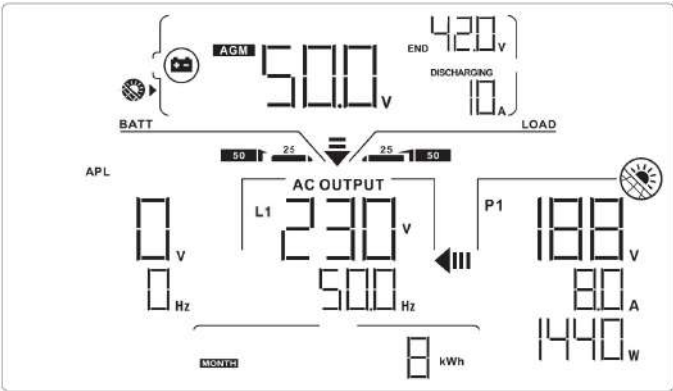
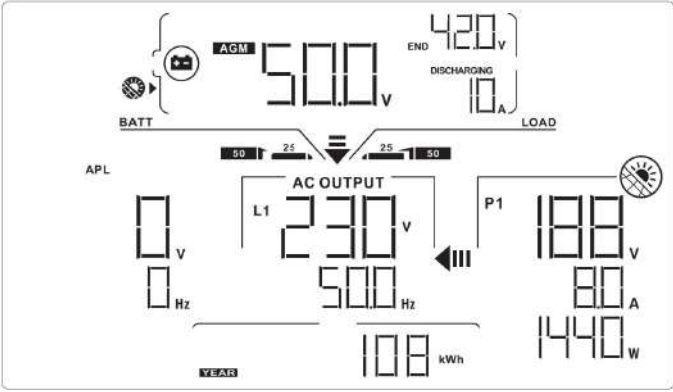
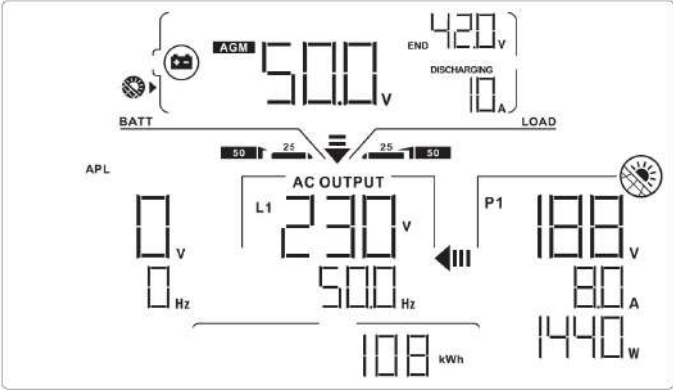

Selectable information	LCD display
PV energy generated today	PV energy generated today = 8Wh. 
PV energy generated this month	PV energy generated this month = 8kWh. 
PV energy generated this year	PV energy generated this year = 108kWh, 
Total PV energy generation	Total PV energy generation = 108kWh. 

Selectable information	LCD display
Main CPU version checking.	<p>Main CPU version 00050.72.</p>
Secondary CPU version checking.	<p>Secondary CPU version 00022.01.</p>

## Operating Mode Description

Operating mode	Behaviors	LCD display
<p>Standby mode</p> <p><b>Note:</b></p> <p>*Standby mode: The inverter is not turned on yet but at this time, the inverter can charge battery without AC output.</p> <p>*Power saving mode: If enabled, the output of inverter will be off when connected load is pretty low or not detected.</p>	<p>No output power, solar or utility charger available</p>	<p>Battery is charged by utility.</p>
		<p>Battery is charged by PV energy.</p>



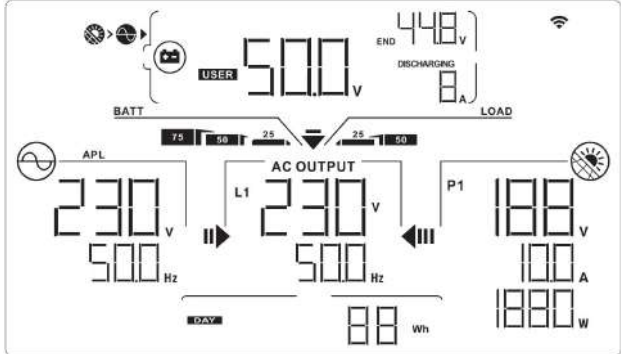
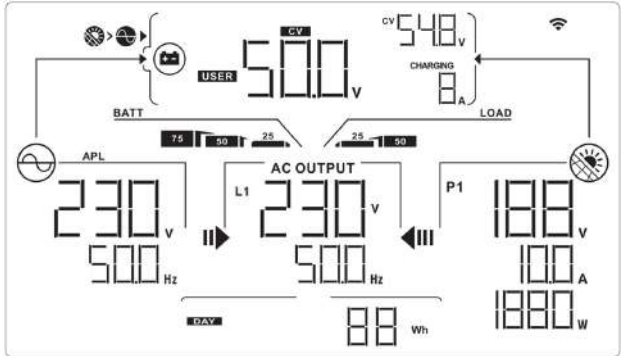
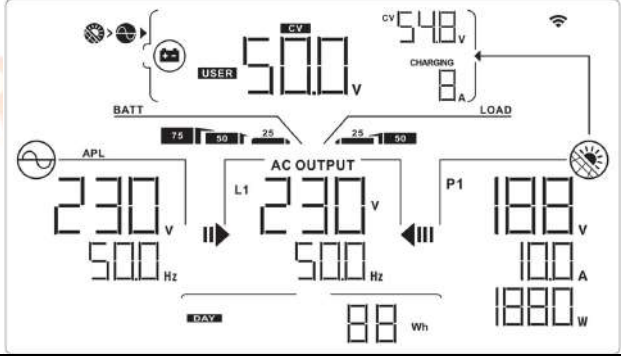
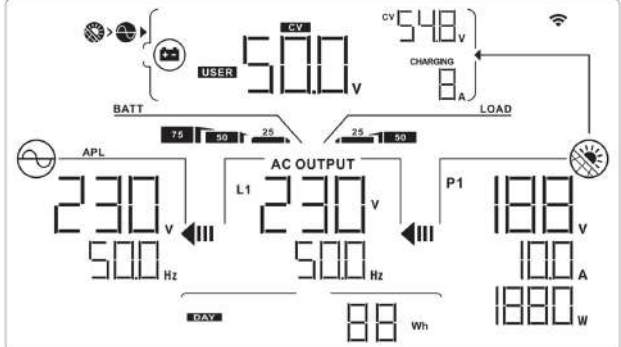



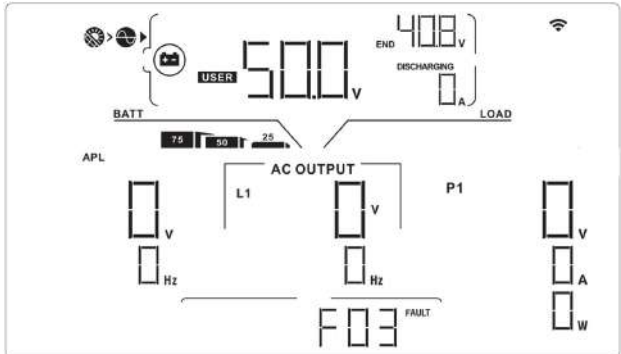

<p>Standby mode</p> <p><b>Note:</b></p> <p>*Standby mode: The inverter is not turned on yet but at this time, the inverter can charge battery without AC output.</p> <p>*Power saving mode: If enabled, the output of inverter will be off when connected load is pretty low or not detected.</p>	<p>No output power, solar or utility charger available</p>	<p>Battery is charged by utility and PV energy.</p>
		<p>Battery is charged by PV energy and feed PV energy to grid.</p>
		<p>No charging.</p>
<p>Line mode</p>	<p>Output power from utility. Charger is available</p>	<p>Utility charges battery and provides power to load.</p>

<p>Line Mode</p>	<p>Output power from utility. Charger is available</p>	<p>PV energy, battery power and utility provide power to load.</p> 
		<p>PV energy and utility charge battery, and utility provides power to load.</p> 
		<p>PV energy charges battery, utility and PV energy provide power to the load.</p> 
		<p>PV energy charges battery, PV energy provides power to the load and feeds remaining energy to the grid.</p> 

		<p>PV energy and battery energy supply power to the load.</p>
<p>Battery mode</p>	<p>Output power from battery or PV</p>	<p>PV energy charges battery and provides power to the load.</p>
		<p>Battery provides power to the load.</p>
<p>Only PV mode</p>	<p>Output power from PV</p>	<p>PV provides power to the load.</p>

<p>Fault mode</p> <p><b>Note:</b></p> <p>*Fault mode: Errors are caused by inside circuit error or external reasons such as over temperature, output short circuited and so on.</p>	<p>No output, no charging.</p>	<p>No charging.</p> 
---	--------------------------------	--

## Warning Indicator

Warning Code	Warning Event	Icon flashing
01	Fan locked	01 
02	Over temperature	02 
03	Battery over charged	03 
04	Low battery	04 
07	Overload	07  
10	Inverter power derating	10 
bP	Battery is not connected	bP 
32	Communication lost between com. port and control board	32 

## Faults Reference Code

Fault Code	Fault Event	Icon on
01	Fan is locked.	F01
02	Over temperature	F02
03	Battery voltage is too high.	F03
05	Output is short circuited.	F05
06	Output voltage is abnormal.	F06
07	Overload time out.	F07
08	Bus voltage is too high.	F08
09	Bus soft start failure.	F09
10	PV current is over.	F10
11	PV voltage is over.	F11
12	Charge current is over.	F12
51	Over current or surge	F51
52	Bus voltage is too low.	F52
53	Inverter soft start failure.	F53
55	Over DC offset in AC output	F55
57	Current sensor failure.	F57
58	Output voltage is too low.	F58

## CLEARANCE AND MAINTENANCE FOR ANTI-DUST KIT

### Overview

Every inverter is already installed with anti-dusk kit from factory. Inverter will automatically detect this kit and activate internal thermal sensor to adjust internal temperature. This kit also keeps dusk from your inverter and increases product reliability in harsh environment.

### Clearance and Maintenance

**Step 1:** Remove the screws on the top of the inverter.

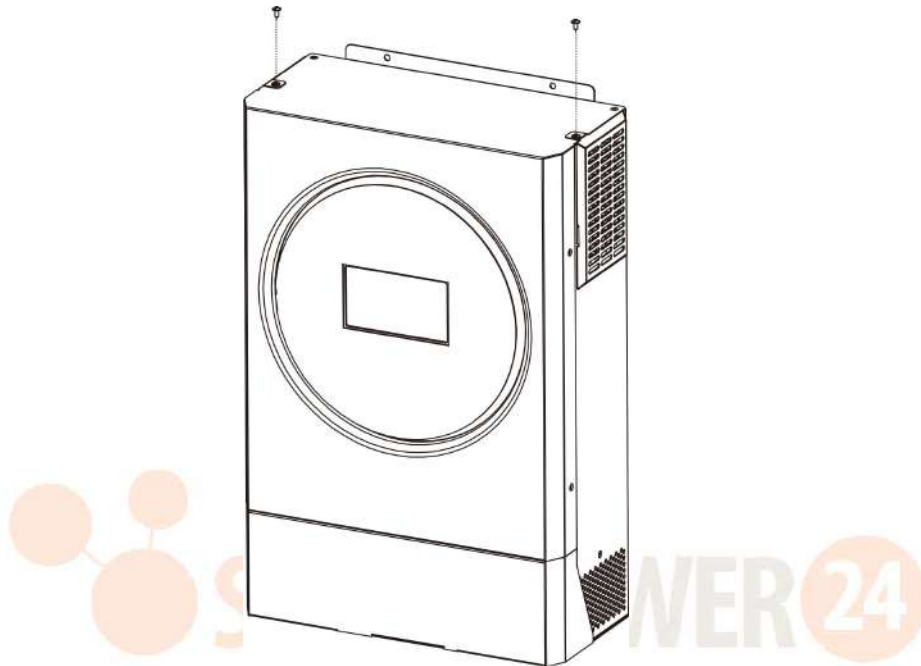

**Step 2:** Then, dustproof case can be removed and take out air filter foam as shown in below chart.

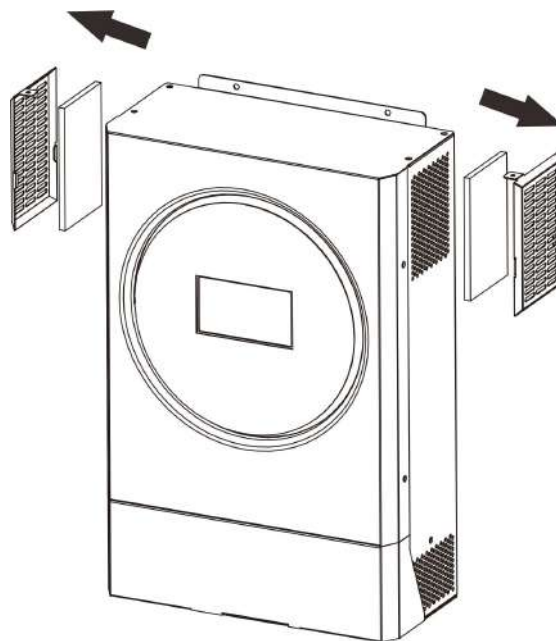

**Step 3:** Clean air filter foam and dustproof case. After clearance, re-assemble the dust-kit back to the inverter.

**NOTICE:** The anti-dust kit should be cleaned from dust every one month.



## SPECIFICATIONS

<b>MODEL</b>	<b>6KW TWIN</b>
<b>RATED OUTPUT POWER</b>	6000W
<b>PV INPUT (DC)</b>	
Max. PV Power	6000W
Max. PV Array Open Circuit Voltage	500 VDC
PV Input Voltage Range	120 VDC~500 VDC
MPPT Range @ Operating Voltage	120 VDC~430 VDC
Max. PV Array Short Circuit Current	27A
Number of MPP Tracker	1
<b>GRID-TIE OPERATION</b>	
<b>GRID OUTPUT (AC)</b>	
Nominal Output Voltage	220/230/240 VAC
Feed-in Grid Voltage Range	195.5~253 VAC @India regulation 184 ~ 264.5 VAC @Germany regulation 184 ~ 264.5 VAC @South America regulation
Feed-in Grid Frequency Range	49~51Hz @India regulation 47.5~51.5Hz @Germany regulation 57~62Hz @South America
Nominal Output Current	26A
Power Factor Range	>0.99
Maximum Conversion Efficiency (DC/AC)	96%
<b>OFF-GRID, HYBRID OPERATION</b>	
<b>GRID INPUT</b>	
Acceptable Input Voltage Range	90 - 280 VAC or 170 - 280 VAC
Frequency Range	50 Hz/60 Hz (Auto sensing)
Transfer Time	< 10ms (For UPS) < 20ms (For Home Appliances) < 50ms (For parallel operation)
Rating of AC Transfer Relay	40A
<b>BATTERY MODE OUTPUT (AC)</b>	
Nominal Output Voltage	220/230/240 VAC
Output Waveform	Pure Sine Wave
Efficiency (DC to AC)	93%
<b>BATTERY &amp; CHARGER</b>	
Nominal DC Voltage	48 VDC
Maximum Charging Current (from Grid)	120A
Maximum Charging Current (from PV)	120A
Maximum Charging Current	120A
<b>GENERAL</b>	
Dimension, D X W X H (mm)	140 x 295 x 468
Net Weight (kgs)	12
<b>INTERFACE</b>	
Parallel-able	Yes
External Safety Box (Optional)	Yes
Communication	RS232/Dry-Contact/WiFi
<b>ENVIRONMENT</b>	
Humidity	0 ~ 90% RH (No condensing)
Operating Temperature	-10°C to 50°C

## TROUBLE SHOOTING

Problem	LCD/LED/Buzzer	Explanation / Possible cause	What to do
Unit shuts down automatically during startup process.	LCD/LEDs and buzzer will be active for 3 seconds and then complete off.	The battery voltage is too low (<1.91V/Cell)	1. Re-charge battery. 2. Replace battery.
No response after power on.	No indication.	1. The battery voltage is far too low. (<1.4V/Cell) 2. Battery polarity is connected reversed.	1. Check if batteries and the wiring are connected well. 2. Re-charge battery. 3. Replace battery.
Mains exist but the unit works in battery mode.	Input voltage is displayed as 0 on the LCD and green LED is flashing.	Input protector is tripped	Check if AC breaker is tripped and AC wiring is connected well.
	Green LED is flashing.	Insufficient quality of AC power. (Shore or Generator)	1. Check if AC wires are too thin and/or too long. 2. Check if generator (if applied) is working well or if input voltage range setting is correct. (UPS→Appliance)
	Green LED is flashing.	Set "Solar First" as the priority of output source.	Change output source priority to Utility first.
When the unit is turned on, internal relay is switched on and off repeatedly.	LCD display and LEDs are flashing	Battery is disconnected.	Check if battery wires are connected well.
Buzzer beeps continuously and red LED is on.	Fault code 07	Overload error. The inverter is overload 110% and time is up.	Reduce the connected load by switching off some equipment.
	Fault code 05	Output short circuited.	Check if wiring is connected well and remove abnormal load.
	Fault code 02	Internal temperature of inverter component is over 100°C.	Check whether the air flow of the unit is blocked or whether the ambient temperature is too high.
	Fault code 03	Battery is over-charged.	Return to repair center.
		The battery voltage is too high.	Check if spec and quantity of batteries are meet requirements.
	Fault code 01	Fan fault	Replace the fan.
	Fault code 06/58	Output abnormal (Inverter voltage below than 190Vac or is higher than 260Vac)	1. Reduce the connected load. 2. Return to repair center
	Fault code 08/09/53/57	Internal components failed.	Return to repair center.
	Fault code 10	Surge	Restart the unit, if the error happens again, please return to repair center.
	Fault code 12	DC/DC over current or surge.	
	Fault code 51	Over current or surge.	
	Fault code 52	Bus voltage is too low.	
	Fault code 55	Output voltage is unbalanced.	
Fault code 56	Battery is not connected well or fuse is burnt.	If the battery is connected well, please return to repair center.	
Fault code 11	Solar input voltage is more than 500V.	Solar input voltage is more than 500V.	

## Appendix I: Parallel function

### 1. Introduction

This inverter can be used in parallel with two different operation modes.

1. Parallel operation in single phase is with up to 9 units. The supported maximum output power is 54KW/54KVA.
2. Maximum 9 units work together to support three-phase equipment. Maximum seven units support one phase.

**NOTE:** If this unit is bundled with share current cable and parallel cable, this inverter is default supported parallel operation. You may skip section 3. If not, please purchase parallel kit and install this unit by following instruction from professional technical personnel in local dealer.

**WARNING:** Please make sure all output N wires of each inverter should be connected always. Otherwise, it will cause fault in error #72.

### 2. Package Contents

In parallel kit, you will find the following items in the package:

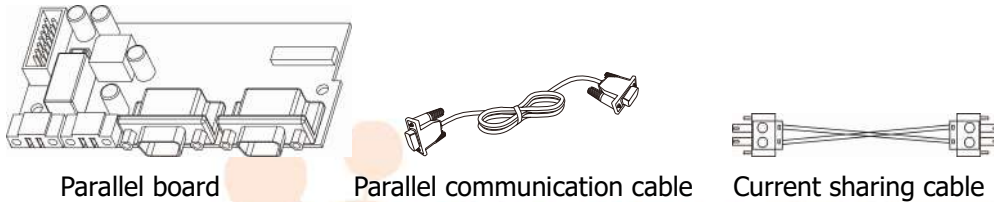

### 3. Parallel board installation

**Step 1:** Remove wire cover by unscrewing all screws.

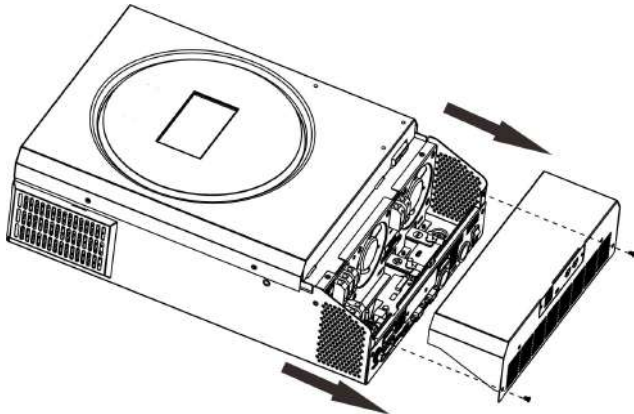

**Step 2:** Remove two screws as below chart and remove 2-pin and 14-pin cables. Take out the board under the communication board.

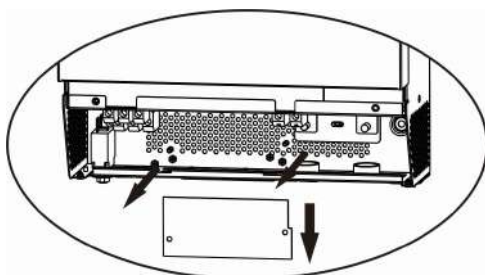

**Step 3:** Remove two screws as below chart to take out cover of parallel communication.

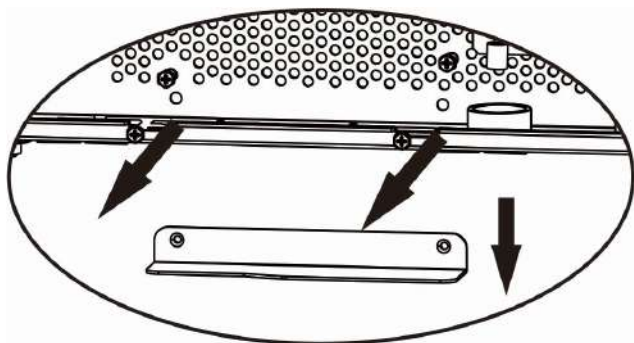

**Step 4:** Install new parallel board with 2 screws tightly.

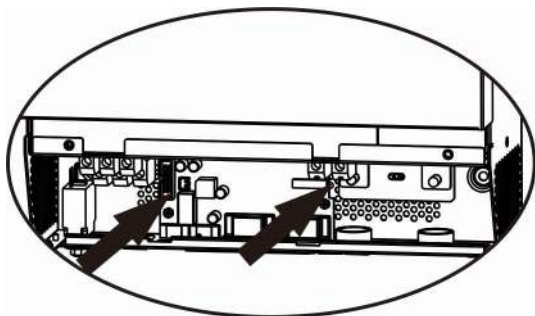

**Step 6:** Connect 2-pin to original position.

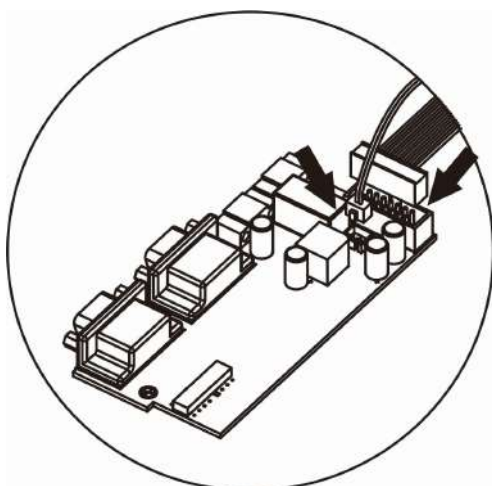

SOLAR POWER 24

**Step 7:** Put communication board back to the unit.

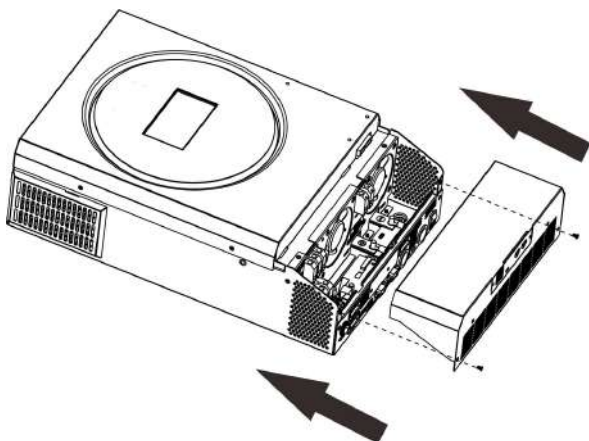

**Step 8:** Put wire cover back to the unit. Now the inverter is providing parallel operation function.

## 4. Mounting the Unit

When installing multiple units, please follow below chart.

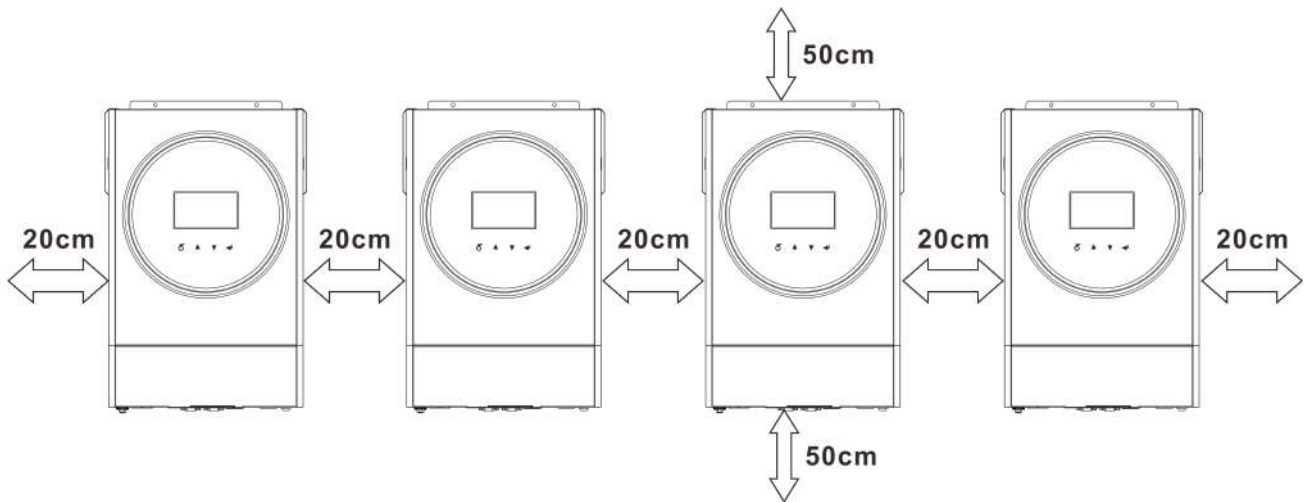

**NOTE:** For proper air circulation to dissipate heat, allow a clearance of approx. 20 cm to the side and approx. 50 cm above and below the unit. Be sure to install each unit in the same level.

## 5. Wiring Connection

**NOTICE:** It's requested to connect to battery for parallel operation.

The cable size of each inverter is shown as below:

**Recommended battery cable and terminal size for each inverter:**

Model	Wire Size	Cable mm <sup>2</sup>	Ring Terminal Dimensions		Torque value
			D (mm)	L (mm)	
6KW TWIN	1*2AWG or 2*6AWG	28	6.4	42.7	2~3 Nm

**Ring terminal:**

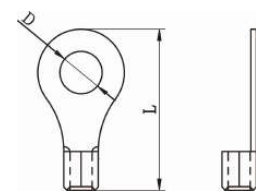

**WARNING:** Be sure the length of all battery cables is the same. Otherwise, there will be voltage difference between inverter and battery to cause parallel inverters not working.

**Recommended AC input and output cable size for each inverter:**

Model	AWG no.	Torque
6KW TWIN	10 AWG	1.2~1.6Nm

You need to connect the cables of each inverter together. Take the battery cables for example: You need to use a connector or bus-bar as a joint to connect the battery cables together, and then connect to the battery terminal. The cable size used from joint to battery should be X times cable size in the tables above. "X" indicates the number of inverters connected in parallel.

Regarding AC input and output, please also follow the same principle.

**WARNING!!** Make sure all output N wires of each inverter must be connected all the time. Otherwise, it will cause inverter fault in error code #72.

**CAUTION!!** Please install the breaker at the battery and AC input side. This will ensure the inverter can be securely disconnected during maintenance and fully protected from over current of battery or AC input. The recommended mounted location of the breakers is shown in the figures in 5-1 and 5-2.

### Recommended breaker specification of battery for each inverter:

Model	1 unit*
6KW TWIN	140A/70VDC

\*If you want to use only one breaker at the battery side for the whole system, the rating of the breaker should be X times current of 1 unit. "X" indicates the number of inverters connected in parallel.

### Recommended breaker specification of AC input with single phase:

Model	2 units	3 units	4 units	5 units	6 units	7 units	8 units	9 units
6KW TWIN	80A/ 230VAC	120A/ 230VAC	160A/ 230VAC	200A/ 230VAC	240A/ 230VAC	280A/ 230VAC	320A/ 230VAC	360A/ 230VAC

**Note1:** Also, you can use 50A for 6KW/6KW TWIN for only 1 unit and install one breaker at its AC input in each inverter.

**Note2:** Regarding three-phase system, you can use 4-pole breaker directly and the rating of the breaker should be compatible with the phase current limitation from the phase with maximum units

### Recommended battery capacity

Inverter parallel numbers	2	3	4	5	6	7	8	9
Battery Capacity	400AH	600AH	800AH	1000AH	1200AH	1400AH	1600AH	1800AH

**WARNING!** Be sure that all inverters will share the same battery bank. Otherwise, the inverters will transfer to fault mode.

### 5-1. Parallel Operation in Single phase

Two inverters in parallel:

#### Power Connection

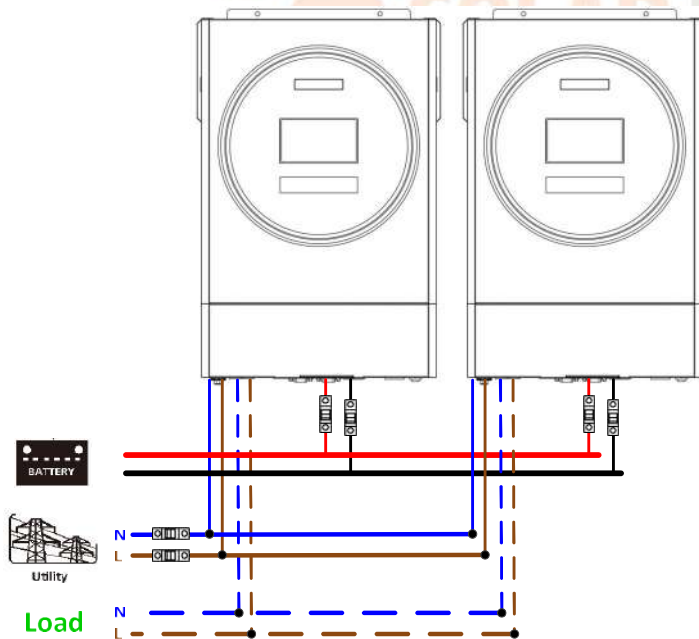

### Communication Connection

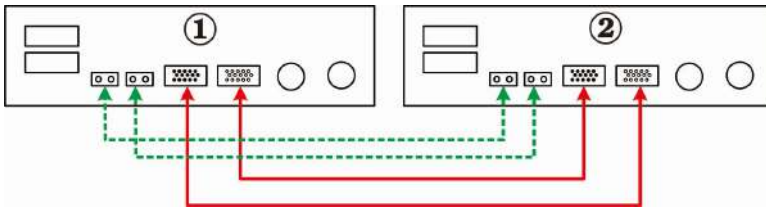

Three inverters in parallel:

### Power Connection

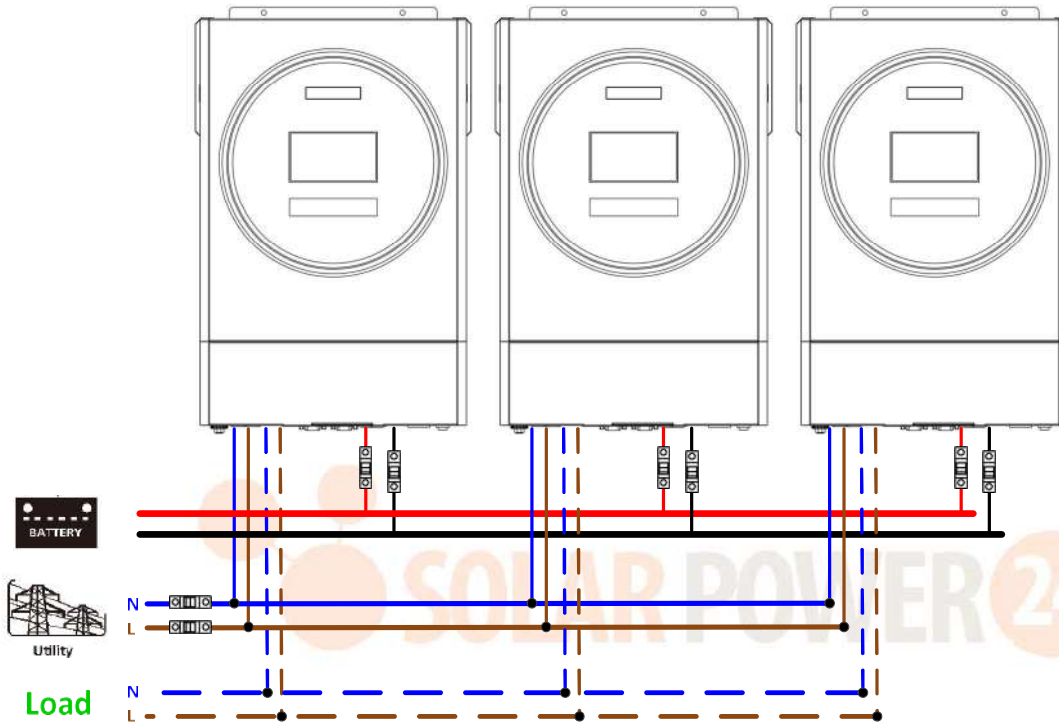

### Communication Connection

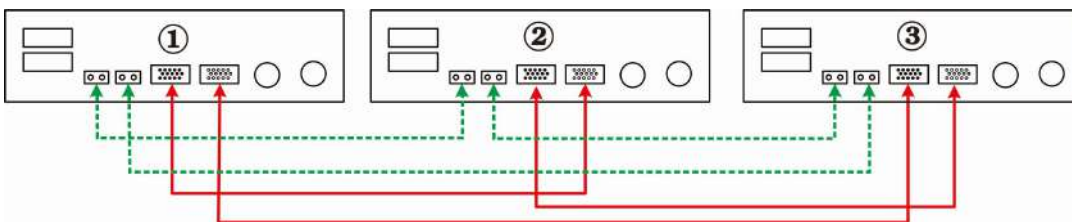

Four inverters in parallel:

**Power Connection**

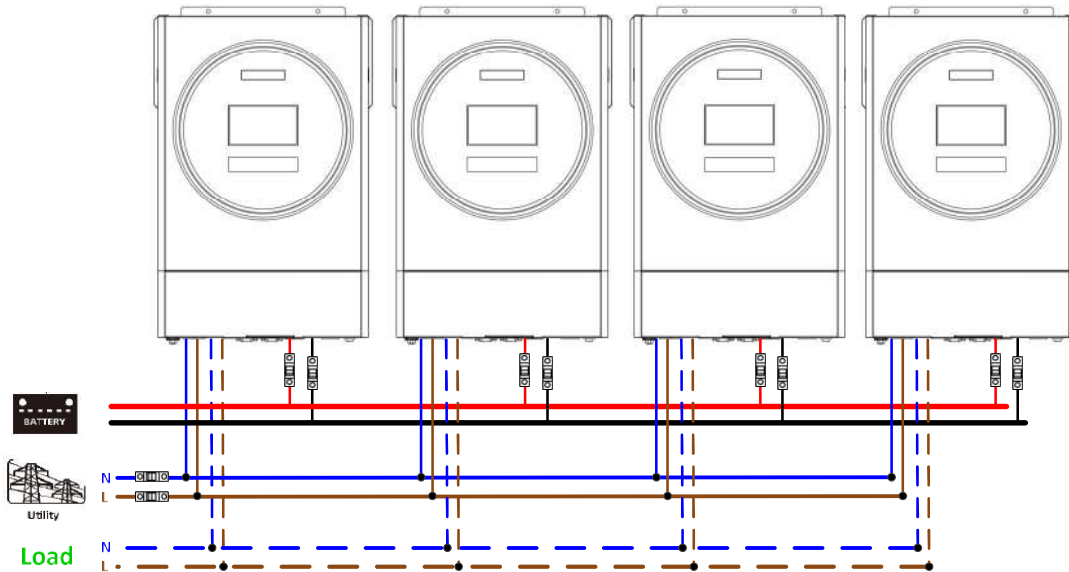

**Communication Connection**

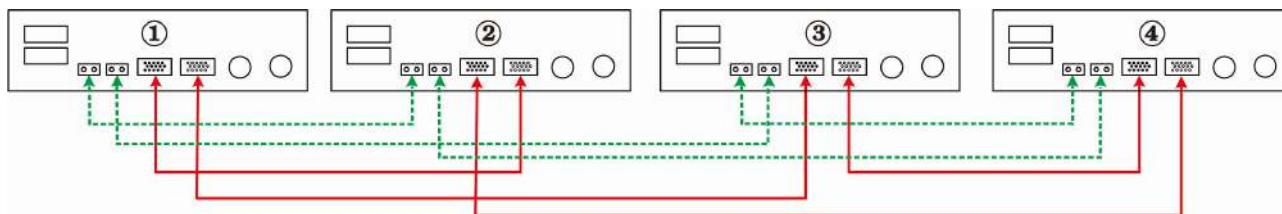

Five inverters in parallel:

**Power Connection**

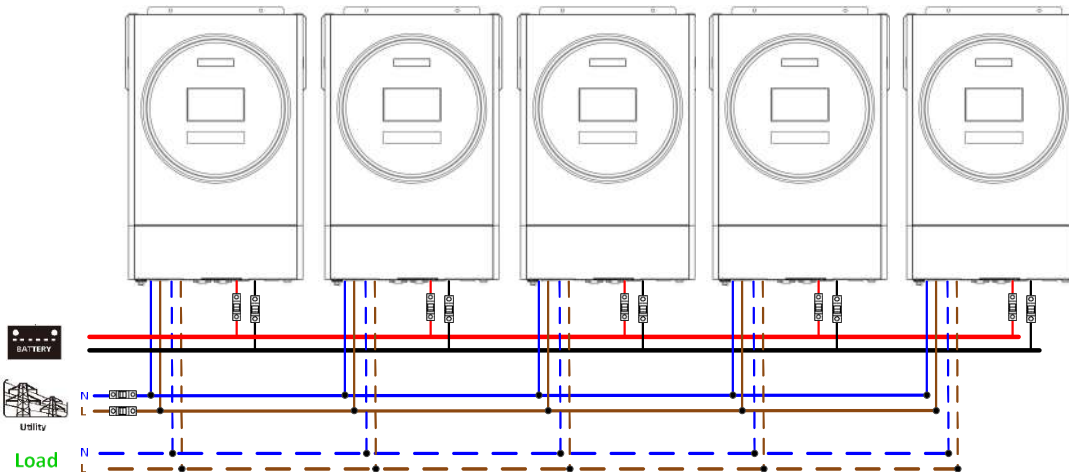

**Communication Connection**

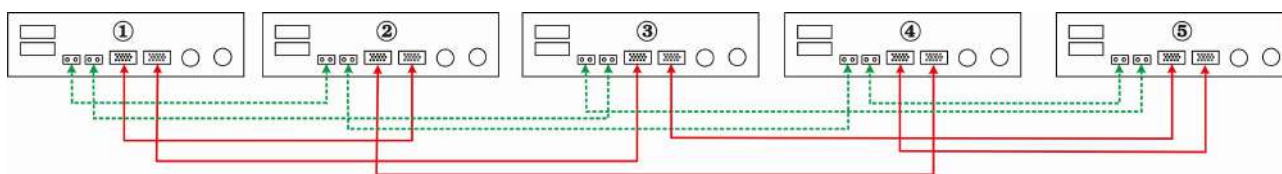



Six inverters in parallel:

### Power Connection

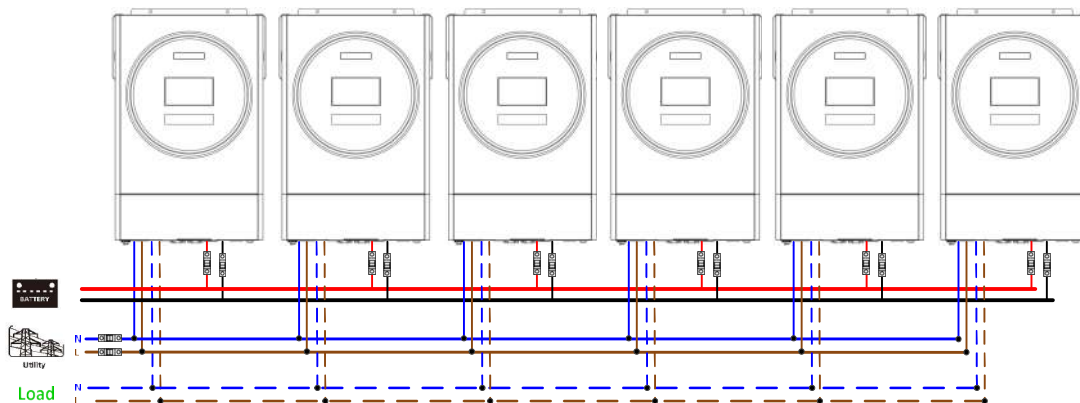

### Communication Connection

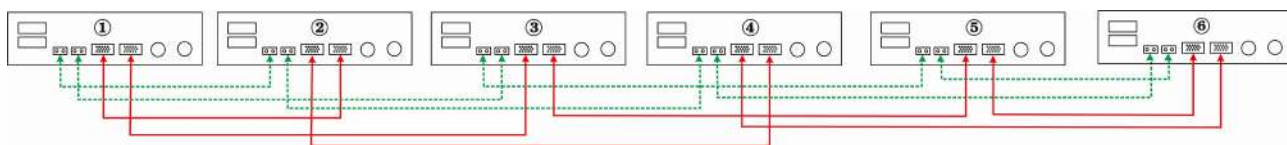

Seven inverters in parallel:

### Power Connection

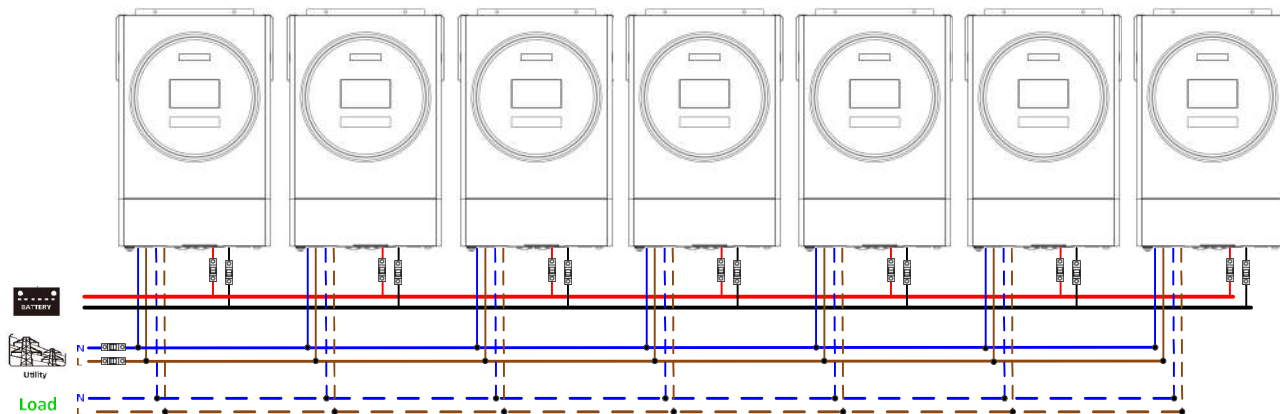

### Communication Connection



Eight inverters in parallel:

**Power Connection**

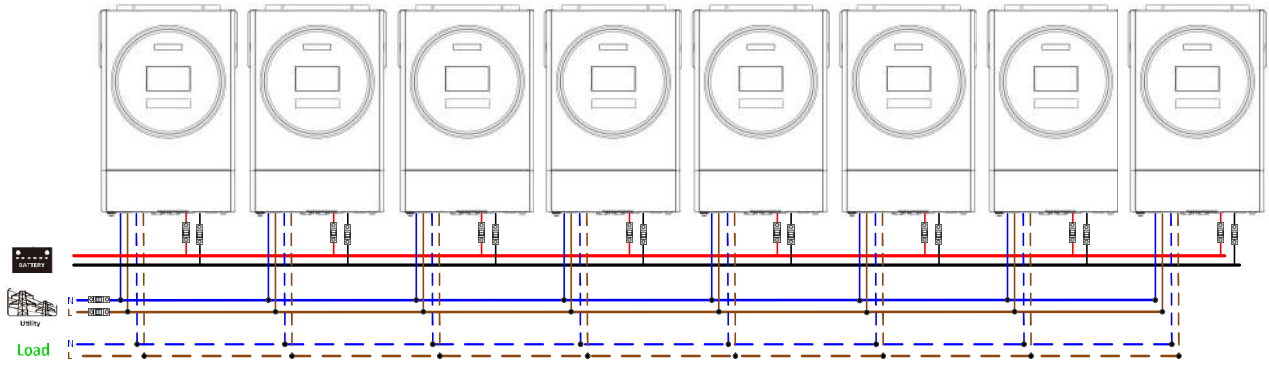

**Communication Connection**

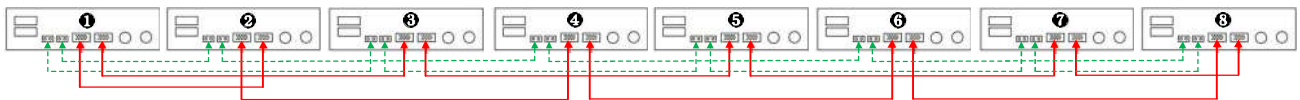

Nine inverters in parallel:

**Power Connection**

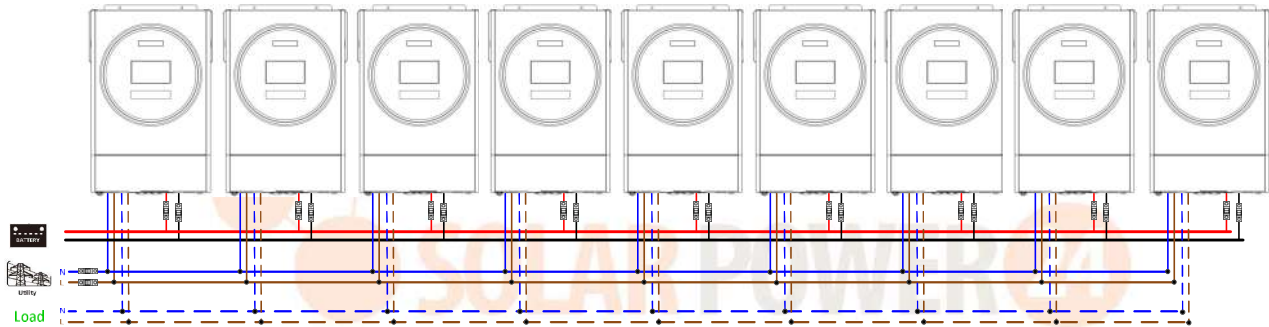

**Communication Connection**

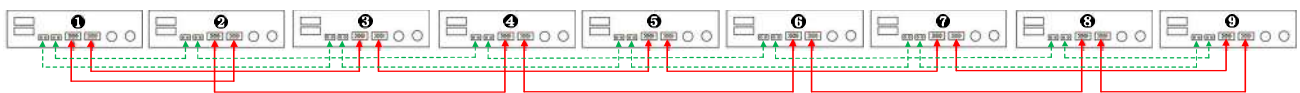

**5-2. Support 3-phase equipment**

Three inverters in each phase:

**Power Connection**

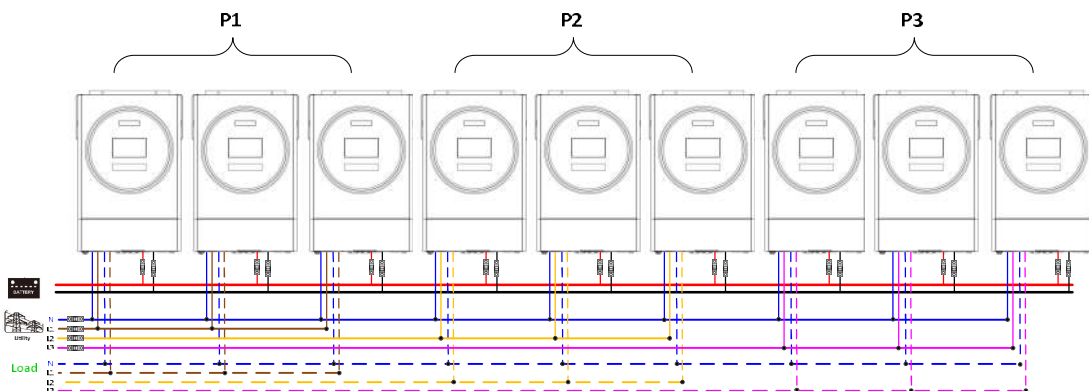

### Communication Connection

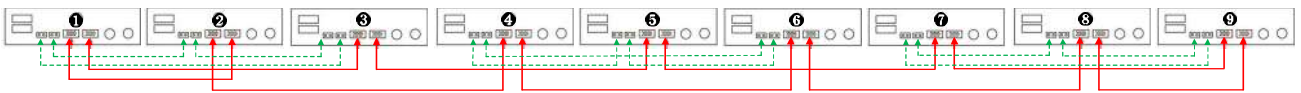

Three inverters in one phase, three inverters in second phase and two inverter for the third phase:

### Power Connection

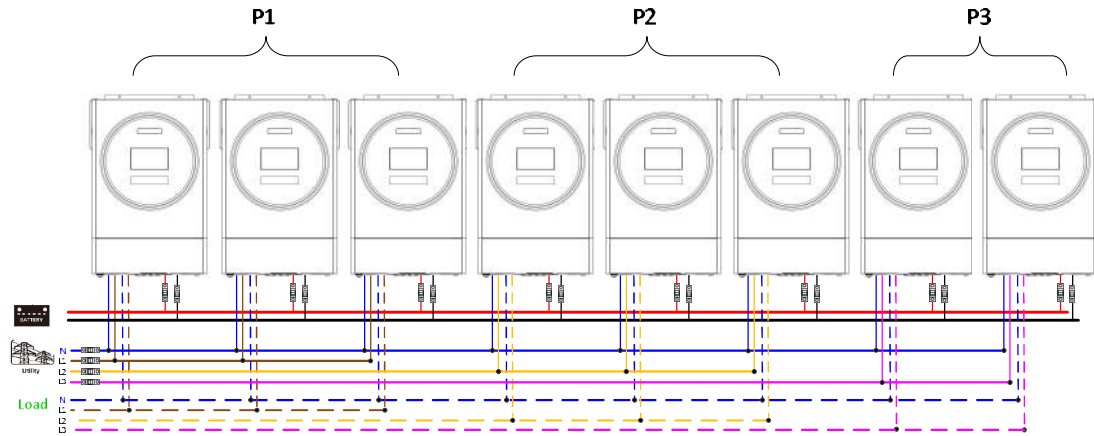

### Communication Connection

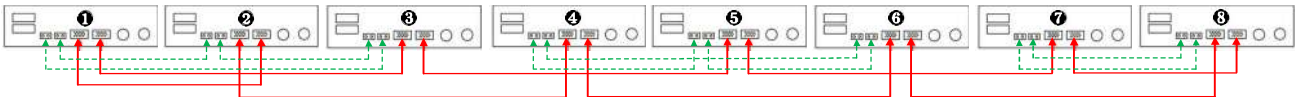

Seven inverters in one phase and one inverter for the other two phases:

### Power Connection

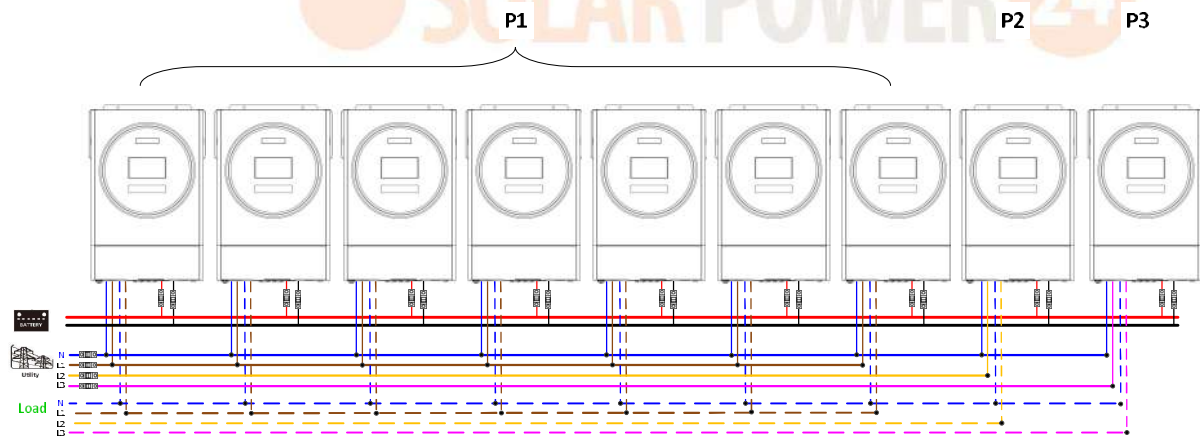

**Note:** It's up to customer's demand to pick 7 inverters on any phase.

P1: L1-phase, P2: L2-phase, P3: L3-phase.

### Communication Connection

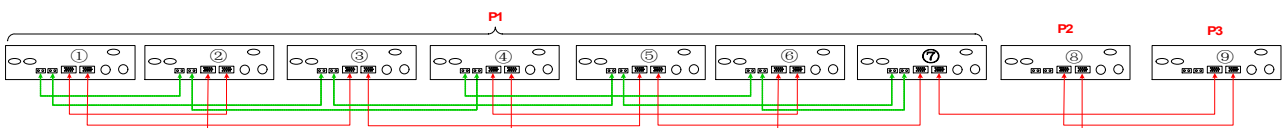

**Note:** If there is only one unit in one phase, this unit doesn't need to connect the current sharing cable.

Or you connect it like as below:

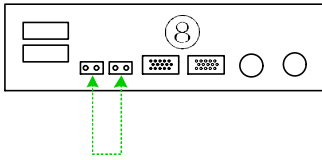

Three inverters in one phase, two inverters in second phase and two inverters for the third phase:

**Power Connection**

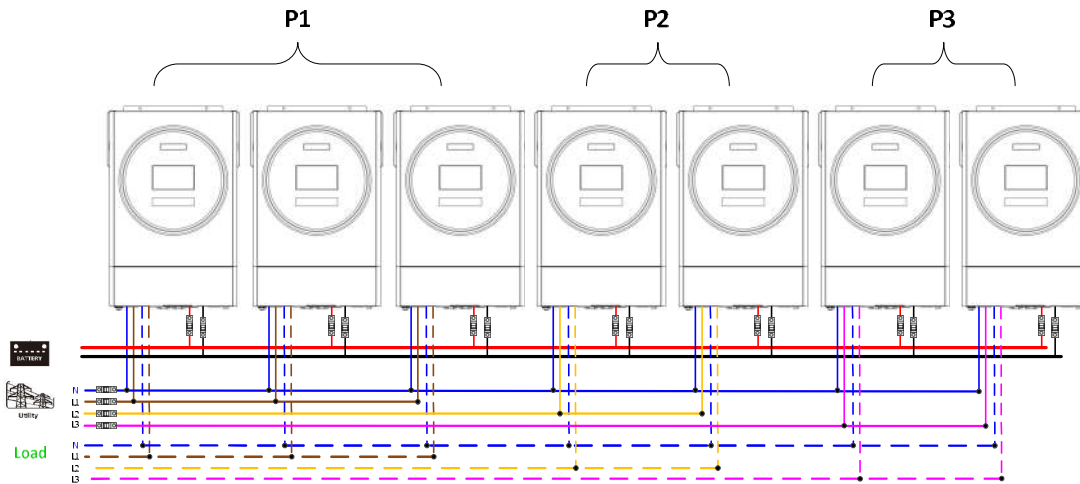

**Communication Connection**

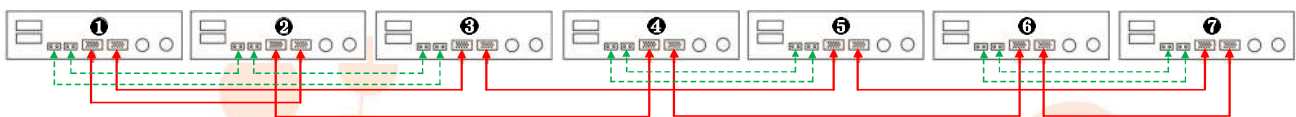

Two inverters in each phase:

**Power Connection**

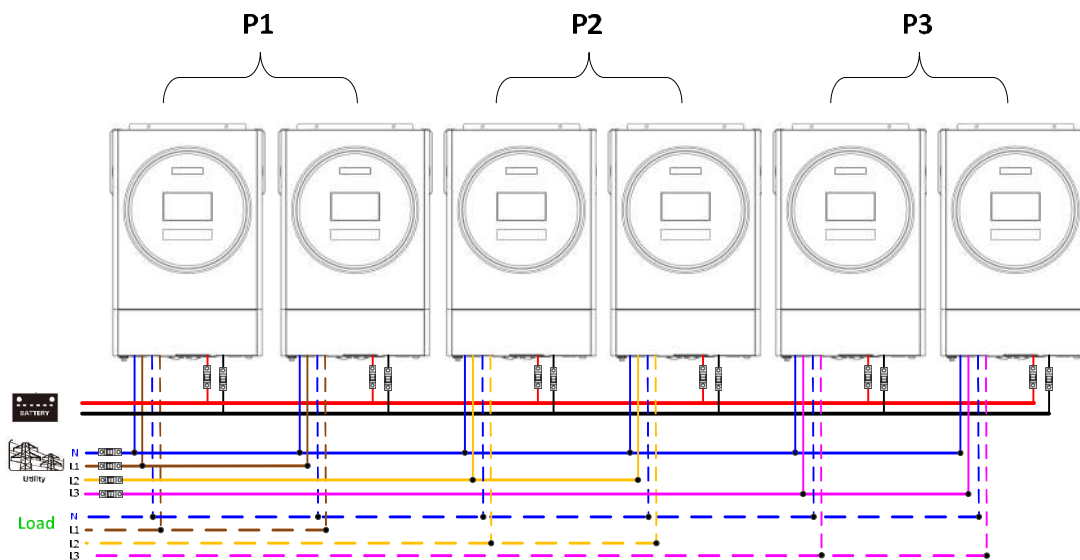

**Communication Connection**

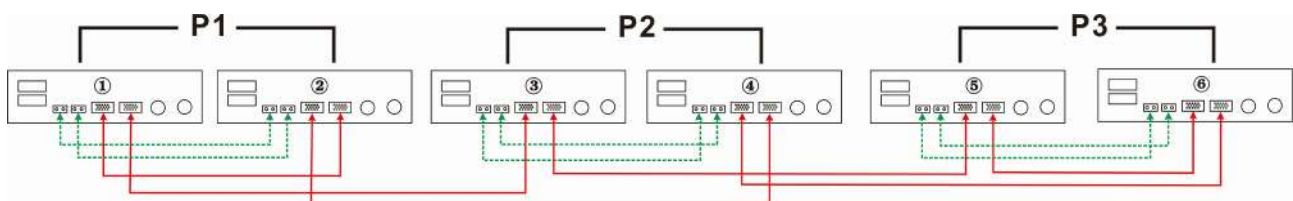

Four inverters in one phase and one inverter for the other two phases:

**Power Connection**

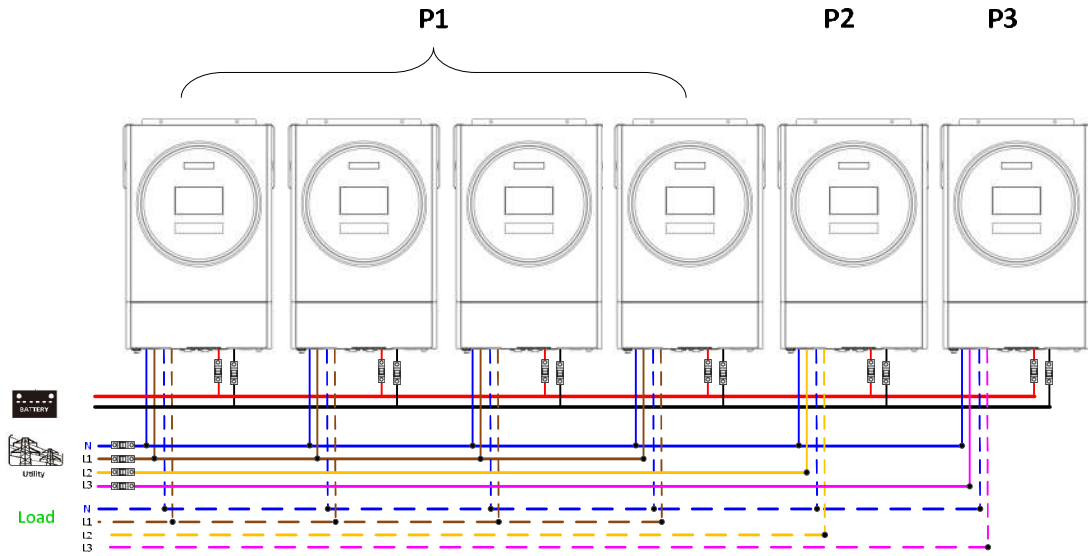

**Communication Connection**

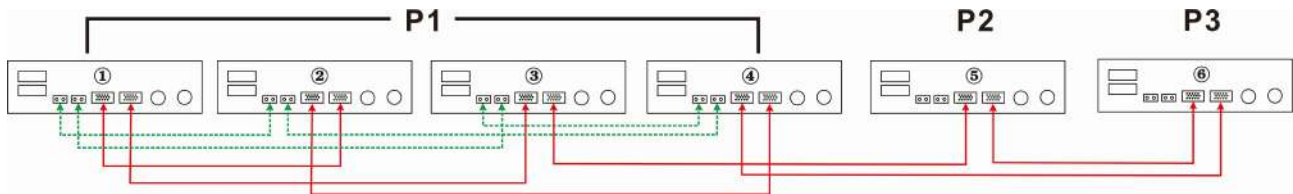

Three inverters in one phase, two inverters in second phase and one inverter for the third phase:

**Power Connection**

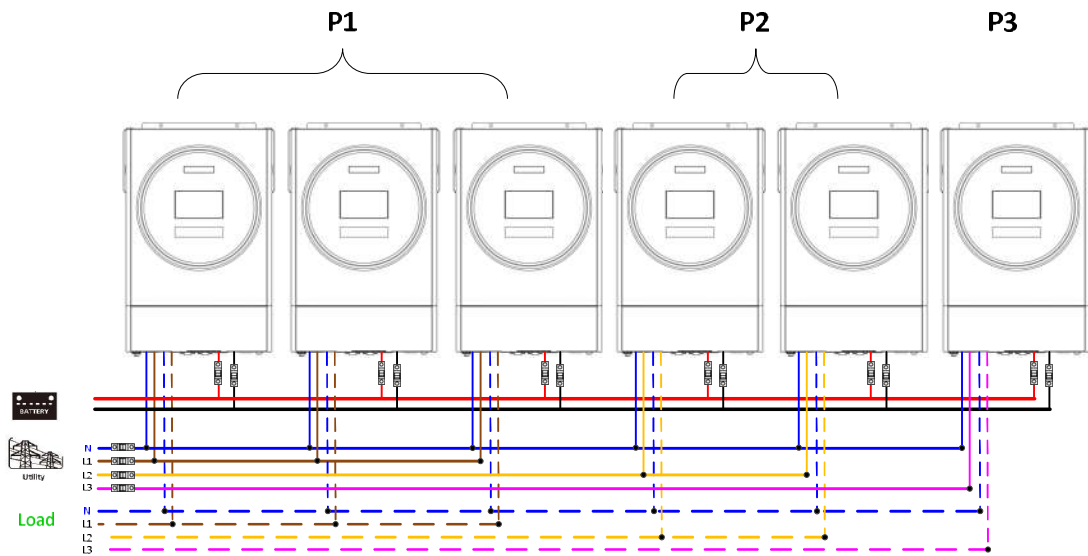

**Communication Connection**

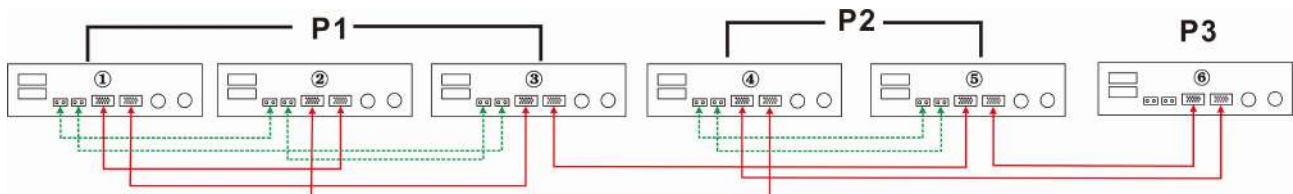



Three inverters in one phase and only one inverter for the remaining two phases:

**Power Connection**

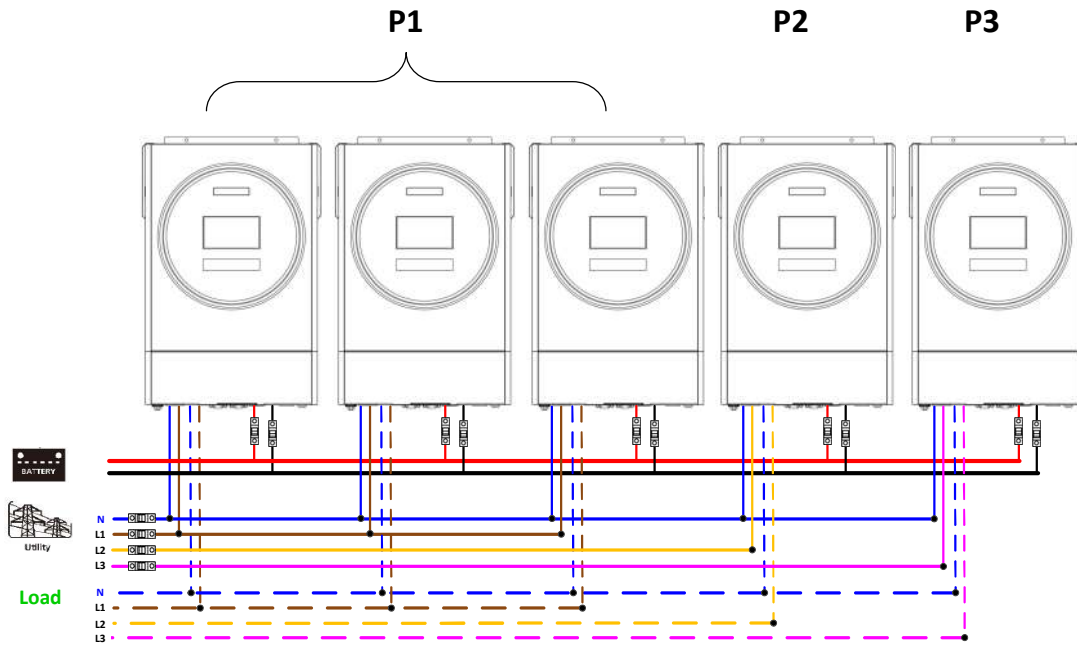

**Communication Connection**

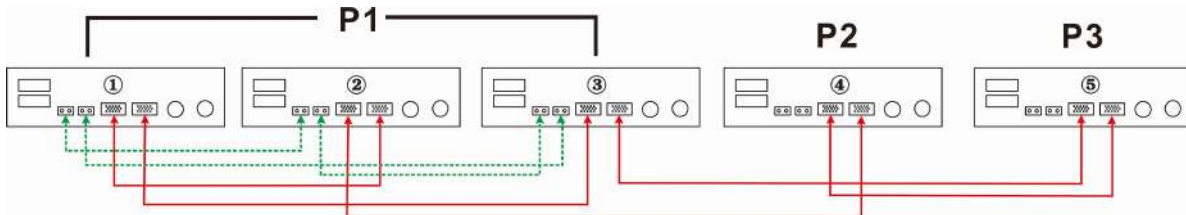

Two inverters in two phases and only one inverter for the remaining phase:

**Power Connection**

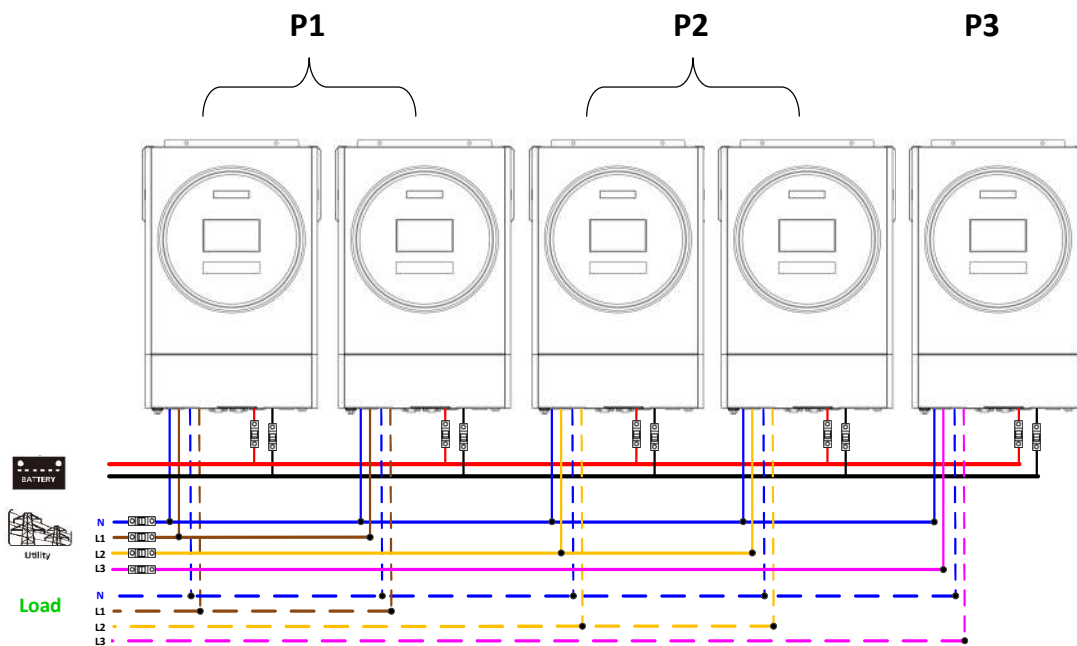

### Communication Connection

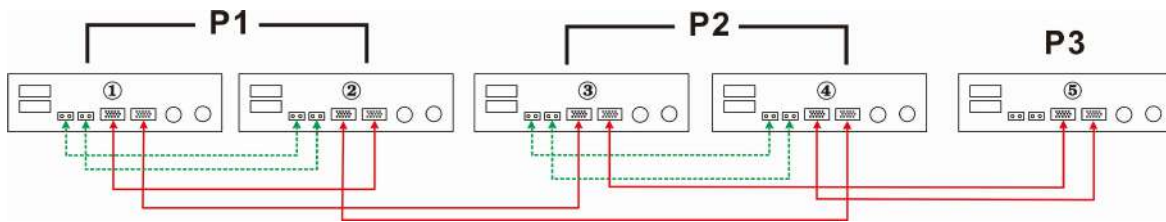

Two inverters in one phase and only one inverter for the remaining phases:

### Power Connection

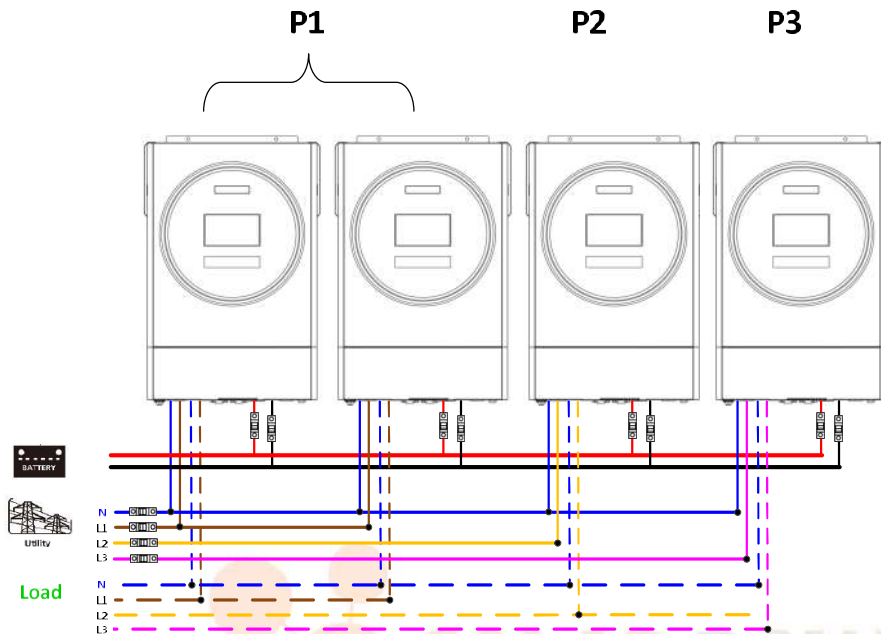

### Communication Connection

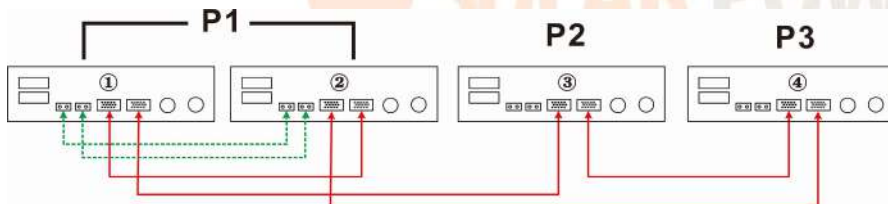

One inverter in each phase:

### Power Connection

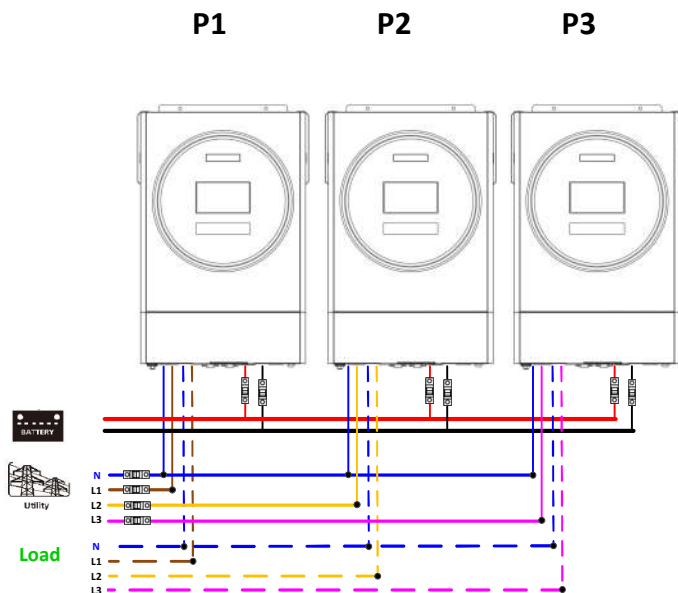



## Communication Connection

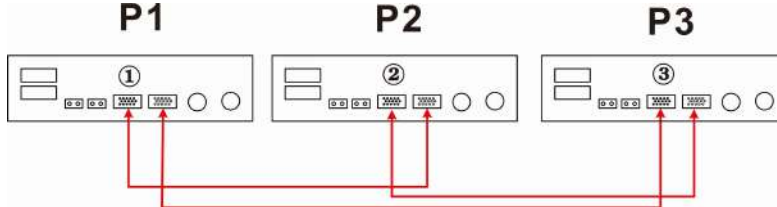

**WARNING:** Do not connect the current sharing cable between the inverters which are in different phases. Otherwise, it may damage the inverters.

## 6. PV Connection

Please refer to user manual of single unit for PV Connection.

**CAUTION:** Each inverter should connect to PV modules separately.

## 7. LCD Setting and Display

### Setting Program:

Program	Description	Selectable option	
28	AC output mode *This setting is only available when the inverter is in standby mode (Switch off).	Single: 	When the units are used in parallel with single phase, please select "PAL" in program 28.
		Parallel: 	It is required to have at least 3 inverters or maximum 9 inverters to support three-phase equipment. It's required to have at least one inverter in each phase or it's up to four inverters in one phase. Please refers to 5-2 for detailed information. Please select "3P1" in program 28 for the inverters connected to L1 phase, "3P2" in program 28 for the inverters connected to L2 phase and "3P3" in program 28 for the inverters connected to L3 phase.
		L1 phase: 	
		L2 phase: 	
		L3 phase: 	Be sure to connect share current cable to units which are on the same phase. Do NOT connect share current cable between units on different phases.  Besides, power saving function will be automatically disabled.

**Fault code display:**

<b>Fault Code</b>	<b>Fault Event</b>	<b>Icon on</b>
60	Power feedback protection	F60
71	Firmware version inconsistent	F71
72	Current sharing fault	F72
80	CAN fault	F80
81	Host loss	F81
82	Synchronization loss	F82
83	Battery voltage detected different	F83
84	AC input voltage and frequency detected different	F84
85	AC output current unbalance	F85
86	AC output mode setting is different	F86

**Code Reference:**

<b>Code</b>	<b>Description</b>	<b>Icon on</b>
NE	Un-identified unit for master or slave	NE
HS	Master unit	HS
SL	Slave unit	SL

## 8. Commissioning

### Parallel in single phase

Step 1: Check the following requirements before commissioning:

- Correct wire connection
- Ensure all breakers in Line wires of load side are open and each Neutral wires of each unit are connected together.

Step 2: Turn on each unit and set "PAL" in LCD setting program 28 of each unit. And then shut down all units.

**NOET:** It's necessary to turn off switch when setting LCD program. Otherwise, the setting can not be programmed.

Step 3: Turn on each unit.

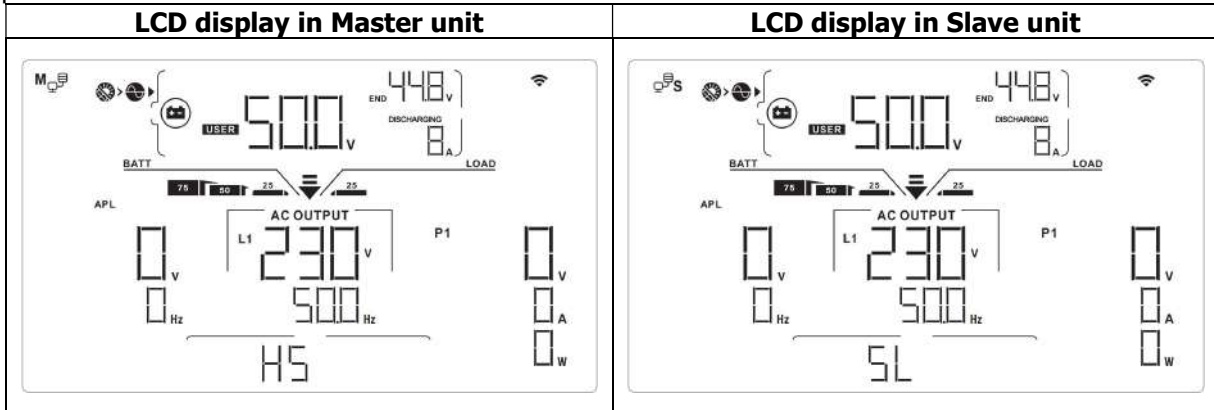

**NOTE:** Master and slave units are randomly defined. Step 4: Switch on all AC breakers of Line wires in AC input. It's better to have all inverters connect to utility at the same time. If not, it will display fault 82 in following-order inverters. However, these inverters will automatically restart. If detecting AC connection, they will work normally.

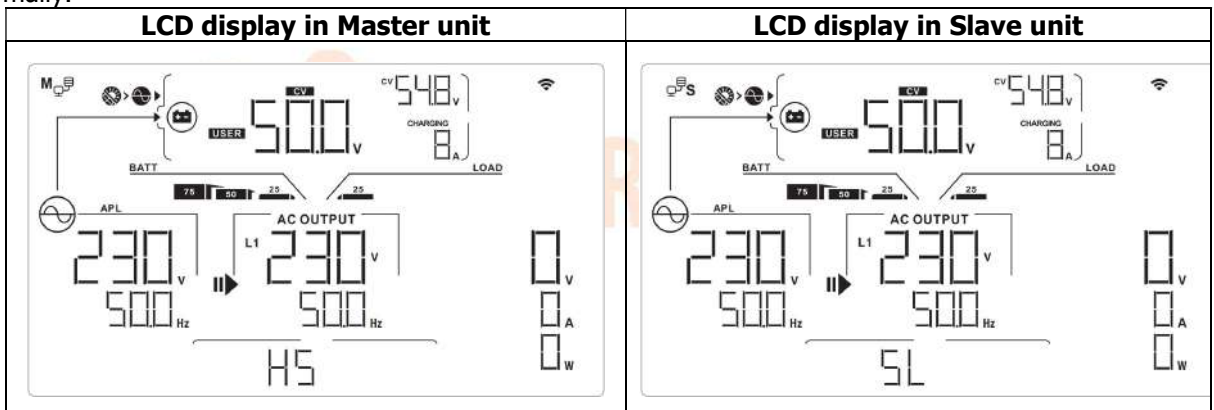

Step 5: If there is no more fault alarm, the parallel system is completely installed.

Step 6: Please switch on all breakers of Line wires in load side. This system will start to provide power to the load.

### Support three-phase equipment

Step 1: Check the following requirements before commissioning:

- Correct wire connection
- Ensure all breakers in Line wires of load side are open and each Neutral wires of each unit are connected together.

Step 2: Turn on all units and configure LCD program 28 as P1, P2 and P3 sequentially. And then shut down all units.

**NOET:** It's necessary to turn off switch when setting LCD program. Otherwise, the setting can not be programmed.

Step 3: Turn on all units sequentially.

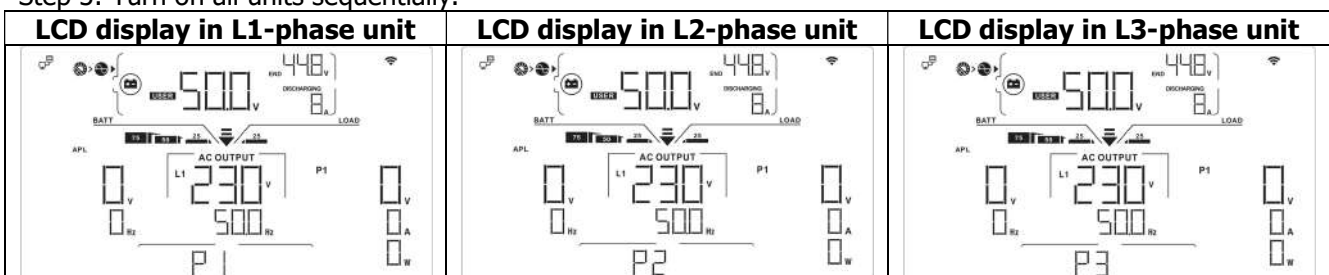

Step 4: Switch on all AC breakers of Line wires in AC input. If AC connection is detected and three phases are matched with unit setting, they will work normally. Otherwise, the AC icon  will flash and they will not work in line mode.

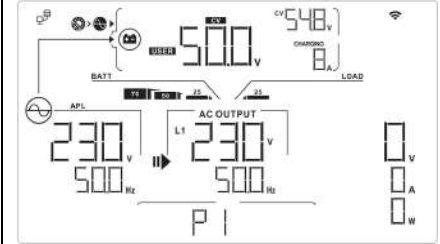
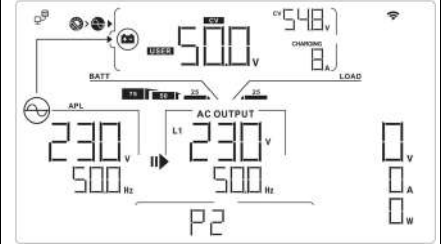
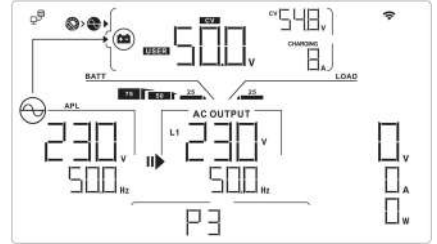
LCD display in L1-phase unit	LCD display in L2-phase unit	LCD display in L3-phase unit
		

Step 5: If there is no more fault alarm, the system to support 3-phase equipment is completely installed.

Step 6: Please switch on all breakers of Line wires in load side. This system will start to provide power to the load.

Note 1: To avoid overload occurring, before turning on breakers in load side, it's better to have whole system in operation first.

Note 2: Transfer time for this operation exists. Power interruption may happen to critical devices, which cannot bear transfer time.

## 9. Trouble shooting

Situation		Solution
Fault Code	Fault Event Description	
60	Current feedback into the inverter is detected.	<ol style="list-style-type: none"> <li>Restart the inverter.</li> <li>Check if L/N cables are not connected reversely in all inverters.</li> <li>For parallel system in single phase, make sure the sharing are connected in all inverters. For supporting three-phase system, make sure the sharing cables are connected in the inverters in the same phase, and disconnected in the inverters in different phases.</li> <li>If the problem remains, please contact your installer.</li> </ol>
71	The firmware version of each inverter is not the same.	<ol style="list-style-type: none"> <li>Update all inverter firmware to the same version.</li> <li>Check the version of each inverter via LCD setting and make sure the CPU versions are same. If not, please contact your installer to provide the firmware to update.</li> <li>After updating, if the problem still remains, please contact your installer.</li> </ol>
72	The output current of each inverter is different.	<ol style="list-style-type: none"> <li>Check if sharing cables are connected well and restart the inverter.</li> <li>If the problem remains, please contact your installer.</li> </ol>
80	CAN data loss	<ol style="list-style-type: none"> <li>Check if communication cables are connected well and restart the inverter.</li> <li>If the problem remains, please contact your installer.</li> </ol>
81	Host data loss	
82	Synchronization data loss	
83	The battery voltage of each inverter is not the same.	<ol style="list-style-type: none"> <li>Make sure all inverters share same groups of batteries together.</li> <li>Remove all loads and disconnect AC input and PV input. Then, check battery voltage of all inverters. If the values from all inverters are close, please check if all battery cables are the same length and same material type. Otherwise, please contact your installer to provide SOP to calibrate battery voltage of each inverter.</li> <li>If the problem still remains, please contact your installer.</li> </ol>
84	AC input voltage and frequency are detected different.	<ol style="list-style-type: none"> <li>Check the utility wiring connection and restart the inverter.</li> <li>Make sure utility starts up at same time. If there are breakers installed between utility and inverters, please be sure all breakers can be turned on AC input at same time.</li> <li>If the problem remains, please contact your installer.</li> </ol>
85	AC output current unbalance	<ol style="list-style-type: none"> <li>Restart the inverter.</li> <li>Remove some excessive loads and re-check load information from LCD of inverters. If the values are different, please check if AC input and output cables are in the same length and material type.</li> <li>If the problem remains, please contact your installer.</li> </ol>
86	AC output mode setting is different.	<ol style="list-style-type: none"> <li>Switch off the inverter and check LCD setting #28.</li> <li>For parallel system in single phase, make sure no 3P1, 3P2 or 3P3 is set</li> </ol>

- on #28.  
For supporting three-phase system, make sure no "PAL" is set on #28.
- If the problem remains, please contact your installer.

## Appendix II: BMS Communication Installation

### 1. Introduction

If connecting to lithium battery, it is recommended to purchase a custom-made RJ45 communication cable. Please check with your dealer or integrator for details.

This custom-made RJ45 communication cable delivers information and signal between lithium battery and the inverter. These information are listed below:

- Re-configure charging voltage, charging current and battery discharge cut-off voltage according to the lithium battery parameters.
- Have the inverter start or stop charging according to the status of lithium battery.

### 2. Pin Assignment for BMS Communication Port

	Definition
PIN 1	RS232TX
PIN 2	RS232RX
PIN 3	RS485B
PIN 4	NC
PIN 5	RS485A
PIN 6	CANH
PIN 7	CANL
PIN 8	GND

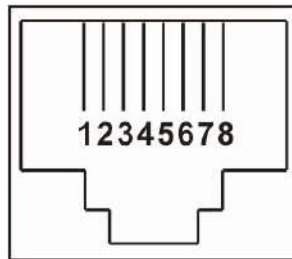

### 3. Lithium Battery Communication Configuration

#### LIO-4805/LIO-4810-150A

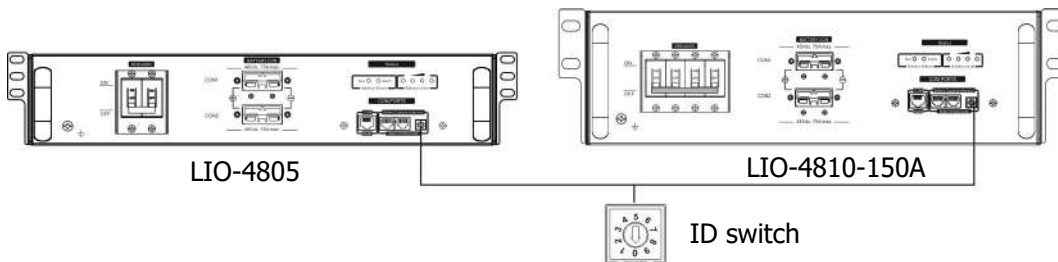

#### ESS LIO-I 4810

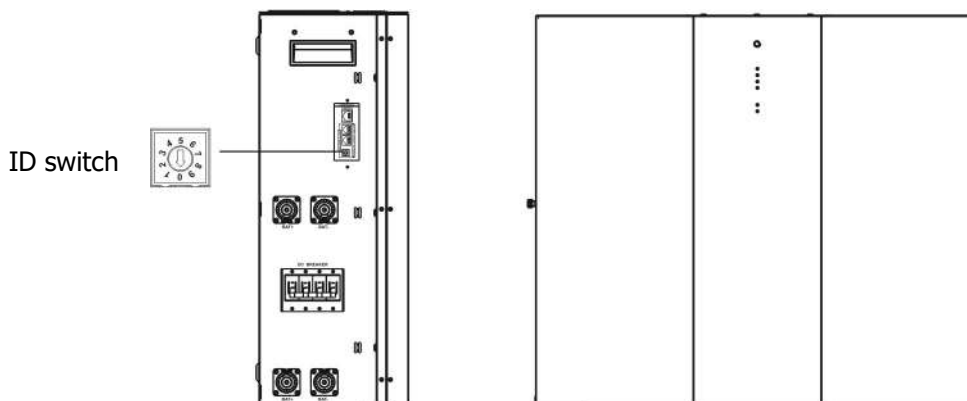

ID Switch indicates the unique ID code for each battery module. It's required to assign a unique ID to each battery module for normal operation. We can set up the ID code for each battery module by rotating the PIN number on the ID switch. From number 0 to 9, the number can be random; no particular order. Maximum 10

battery modules can be operated in parallel.



## PYLONTECH

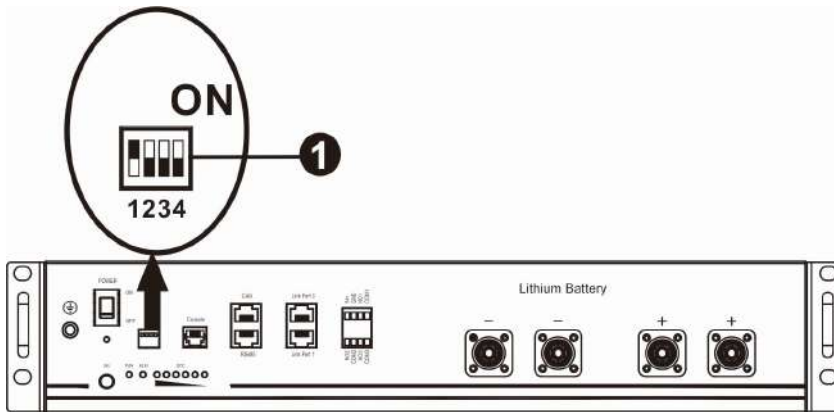

Dip Switch: There are 4 Dip Switches that sets different baud rate and battery group address. If switch position is turned to the "OFF" position, it means "0". If switch position is turned to the "ON" position, it means "1".

Dip 1 is "ON" to represent the baud rate 9600.

Dip 2, 3 and 4 are to set up battery group address.

Dip switch 2, 3 and 4 on master battery (first battery) are to set up or change the group address.

**NOTE:** "1" is upper position and "0" is bottom position.

Dip 1	Dip 2	Dip 3	Dip 4	Group address
1: RS485 baud rate=9600  <b>Restart to take effect</b>	0	0	0	Single group only. It's necessary to set up master battery with this setting and slave batteries are unrestricted.
	1	0	0	Multiple group condition. It's necessary to set up master battery on the first group with this setting and slave batteries are unrestricted.
	0	1	0	Multiple group condition. It's necessary to set up master battery on the second group with this setting and slave batteries are unrestricted.
	1	1	0	Multiple group condition. It's necessary to set up master battery on the third group with this setting and slave batteries are unrestricted.
	0	0	1	Multiple group condition. It's necessary to set up master battery on the forth group with this setting and slave batteries are unrestricted.
	1	0	1	Multiple group condition. It's necessary to set up master battery on the fifth group with this setting and slave batteries are unrestricted.

**NOTE:** The maximum groups of lithium battery is 5 and for maximum number for each group, please check with battery manufacturer.

## 4. Installation and Operation

### LIO-4805/LIO-4810-150A/ESS LIO-I 4810

After ID no. is assigned for each battery module, please set up LCD panel in inverter and install the wiring connection as following steps.

Step 1: Use supplied RJ11 signal cable to connect into the extension port ( P1 or P2 ).

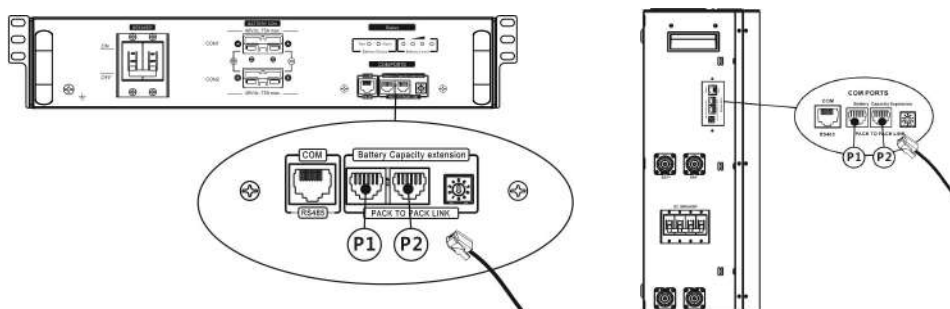

Step 2: Use supplied RJ45 cable (from battery module package) to connect inverter and Lithium battery.

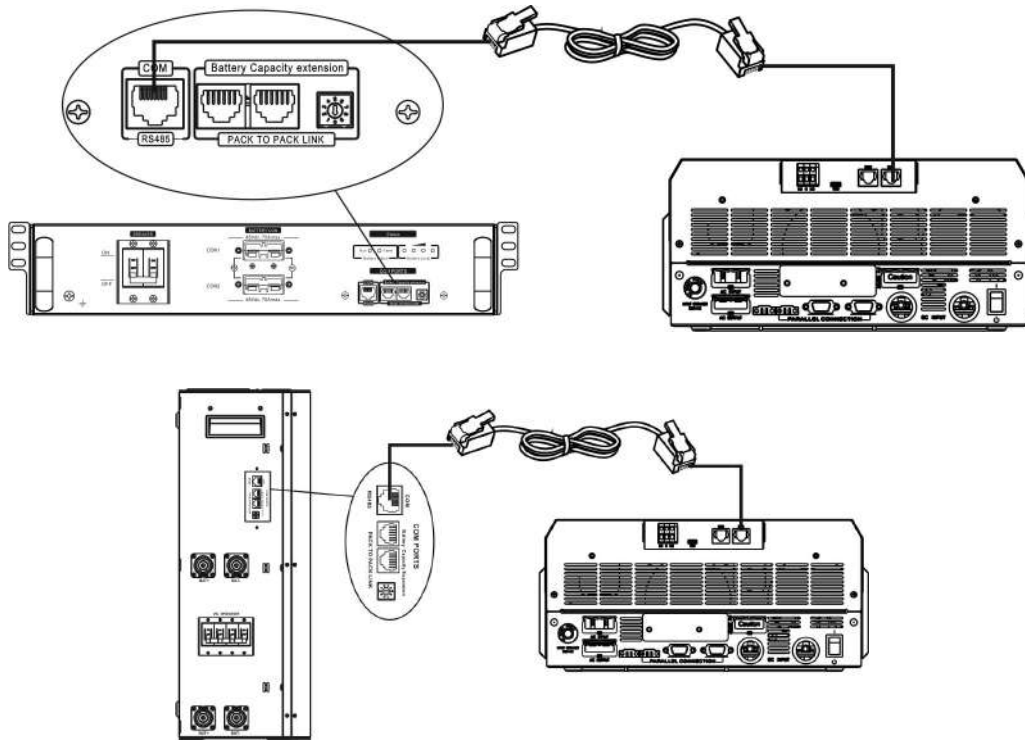

\* For multiple battery connection, please check battery manual for the details.

**Note for parallel system:**

1. Only support common battery installation.
2. Use custom-made RJ45 cable to connect any inverter (no need to connect to a specific inverter) and Lithium battery. Simply set this inverter battery type to "LIB" in LCD program 5. Others should be "USE".

Step 3: Turn the breaker switch "ON". Now, the battery module is ready for DC output.

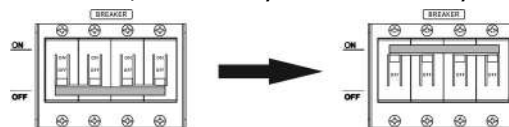

Step 4: Press Power on/off button on battery module for 5 secs, the battery module will start up.

\*If the manual button cannot be approached, just simply turn on the inverter module. The battery module will be automatically turned on.

Step 5: Turn on the inverter.

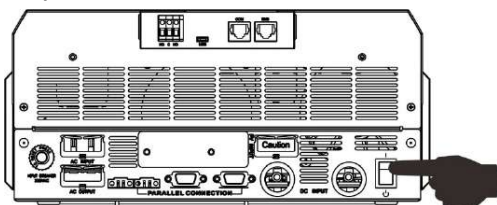

Step 6. Be sure to select battery type as "LIB" in LCD program 5.







If communication between the inverter and battery is successful, the battery icon on LCD display will flash. Generally speaking, it will take longer than 1 minute to establish communication.

**PYLONTECH**

After configuration, please set up LCD panel in inverter and make wiring connection to Lithium battery as the following steps.

Step 1. Use custom-made RJ45 cable to connect inverter and Lithium battery.

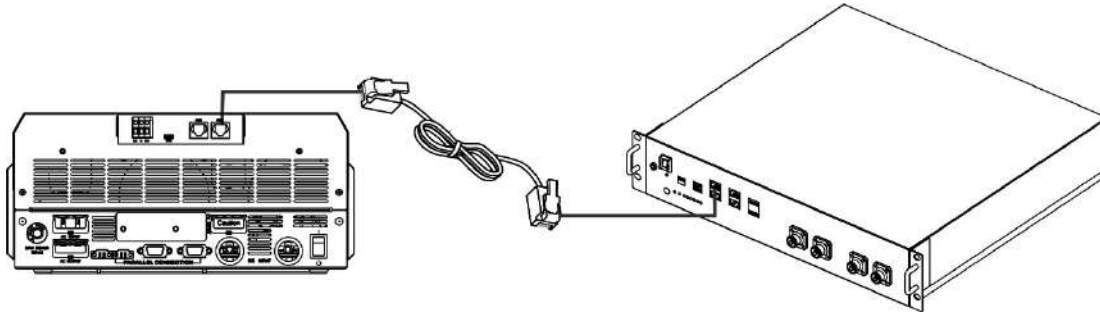

**Note for parallel system:**

- 3. Only support common battery installation.
- 4. Use custom-made RJ45 cable to connect any inverter (no need to connect to a specific inverter) and Lithium battery. Simply set this inverter battery type to "PYL" in LCD program 5. Others should be "USE".

Step 2. Switch on Lithium battery.

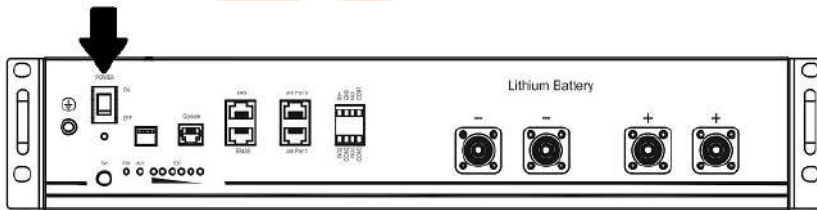

Step 3. Press more than three seconds to start Lithium battery, power output ready.

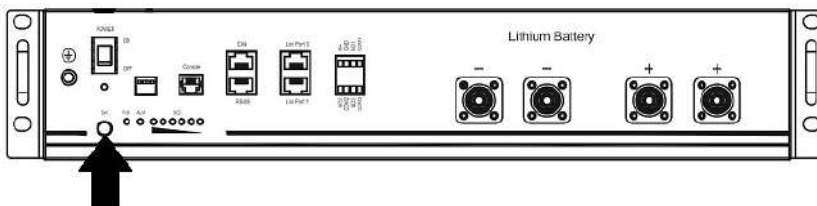

Step 4. Turn on the inverter.

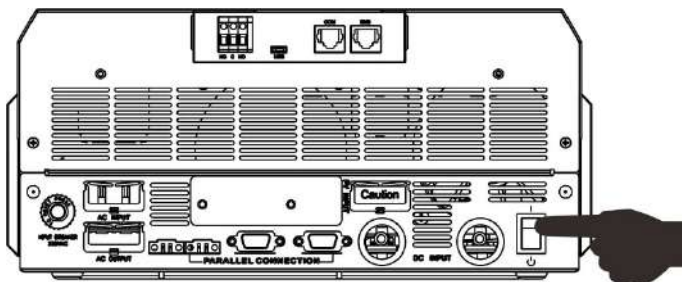

Step 5. Be sure to select battery type as "PYL" in LCD program 14.

05

SETTING ← PYL

### WECO

Step 1. Use custom-made RJ45 cable to connect inverter and Lithium battery.

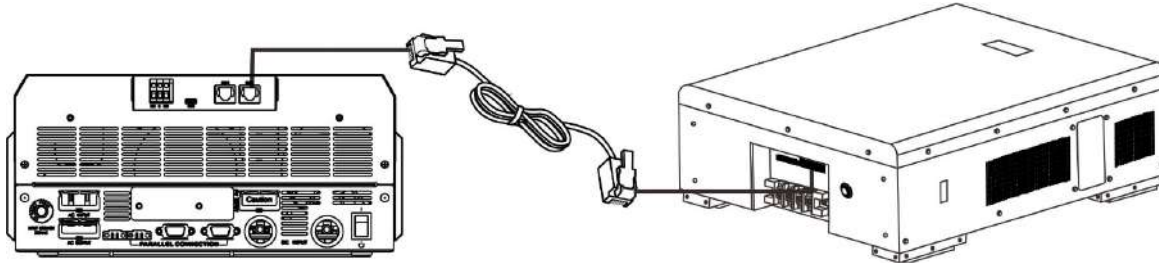

### Note for parallel system:

1. Only support common battery installation.
2. Use custom-made RJ45 cable to connect any inverter (no need to connect to a specific inverter) and Lithium battery. Simply set this inverter battery type to "WEC" in LCD program 5. Others should be "USE".

Step 2. Switch on Lithium battery.

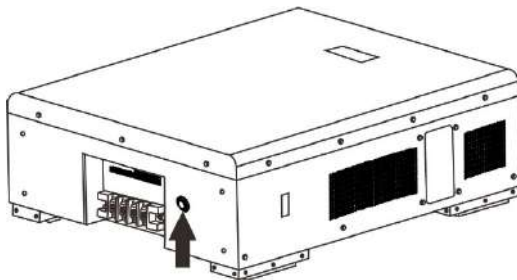

Step 3. Turn on the inverter.

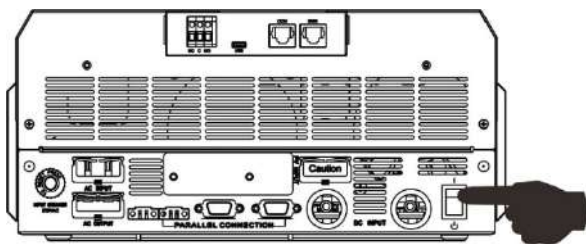

Step 4. Be sure to select battery type as "WEC" in LCD program 5.

05

SETTING ← WEC

### SOLTARO

Step 1. Use custom-made RJ45 cable to connect inverter and Lithium battery.

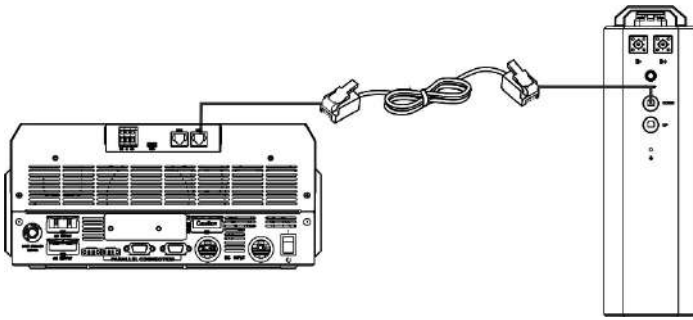

**Note for parallel system:**

1. Only support common battery installation.
2. Use custom-made RJ45 cable to connect any inverter (no need to connect to a specific inverter) and Lithium battery. Simply set this inverter battery type to "SOL" in LCD program 5. Others should be "USE".

Step 2. Open DC isolator and switch on Lithium battery.

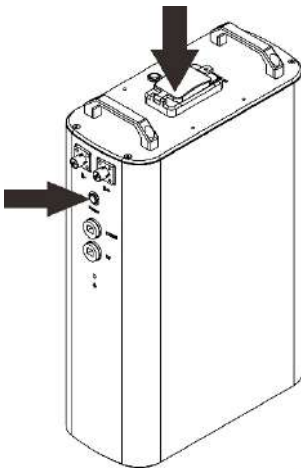

Step 3. Turn on the inverter.

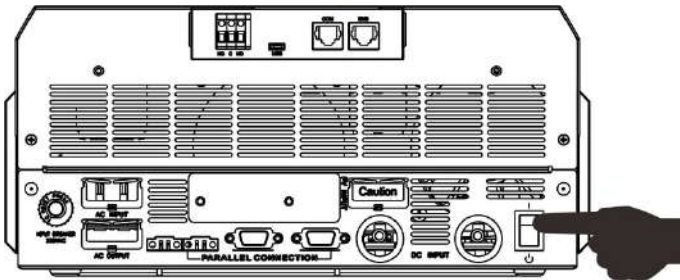

Step 4. Be sure to select battery type as "SOL" in LCD program 5.

05

SETTING → SOL

#### 4. LCD Display Information

Press "UP" or "DOWN" key to switch LCD display information. It will show battery pack and battery group number before "Main CPU version checking" as below screen.

Selectable information	LCD display
Battery pack numbers & Battery group numbers	<p>Battery pack numbers = 3, battery group numbers = 1</p>

#### 5. Code Reference

Related information code will be displayed on LCD screen. Please check inverter LCD screen for the operation.

Code	Description
60	If battery status is not allowed to charge and discharge after the communication between the inverter and battery is successful, it will show code 60 to stop charging and discharging battery.
61	<p>Communication lost (only available when the battery type is setting as "Pylontech Battery" or "WECO Battery" or "Soltaro Battery")</p> <ul style="list-style-type: none"> <li>After battery is connected, communication signal is not detected for 3 minutes, buzzer will beep. After 10 minutes, inverter will stop charging and discharging to lithium battery.</li> <li>Communication lost occurs after the inverter and battery is connected successfully, buzzer beeps immediately.</li> </ul>
69	If battery status is not allowed to charge after the communication between the inverter and battery is successful, it will show code 69 to stop charging battery.
70	If battery status must to charge after the communication between the inverter and battery is successful, it will show code 70 to charge battery.
71	If battery status is not allowed to discharge after the communication between the inverter and battery is successful, it will show code 71 to stop discharge battery.

## Appendix III: The Wi-Fi Operation Guide in Remote Panel

### 1. Introduction

Wi-Fi module can enable wireless communication between off-grid inverters and monitoring platform. Users have complete and remote monitoring and controlling experience for inverters when combining Wi-Fi module with SolarPower APP, available for both iOS and Android based device. All data loggers and parameters are saved in iCloud.

The major functions of this APP:

- Delivers device status during normal operation.
- Allows to configure device setting after installation.
- Notifies users when a warning or alarm occurs.
- Allows users to query inverter history data.

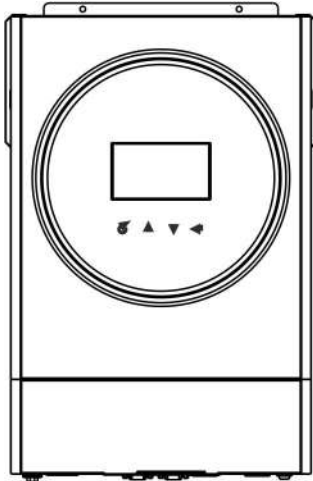

### 2. SolarPower App

#### 2-1. Download and install APP

**Operating system requirement for your smart phone:**

🍏 iOS system supports iOS 9.0 and above

🤖 Android system supports Android 5.0 and above

Please scan the following QR code with your smart phone and download SolarPower App.



Android system





iOS system

Or you may find "SolarPower" app from the Apple® Store or "SolarPower Wi-Fi" in Google® Play Store.



#### 2-2. Initial Setup

Step 1: Registration at first time

After the installation, please tap the shortcut icon  to access this APP on your mobile screen. In the screen, tap "Register" to access "User Registration" page. Fill in all required information and scan the remote box PN by tapping  icon. Or you can simply enter PN directly. Then, tap "Register" button.

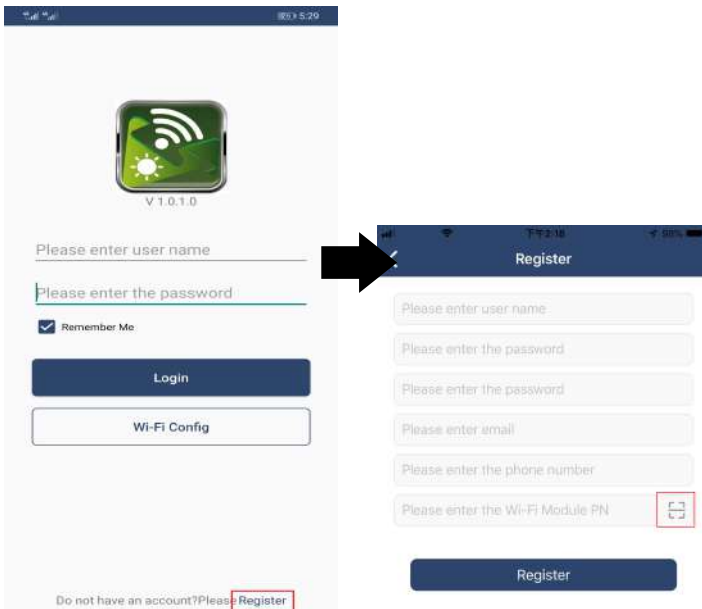

Then, a “Registration success” window will pop up. Tap “Go now” to continue setting local Wi-Fi network connection.



## Step 2: Local Wi-Fi Module Configuration

Now, you are in “Wi-Fi Config” page. There are detailed setup procedure listed in “How to connect?” section and you may follow it to connect Wi-Fi.

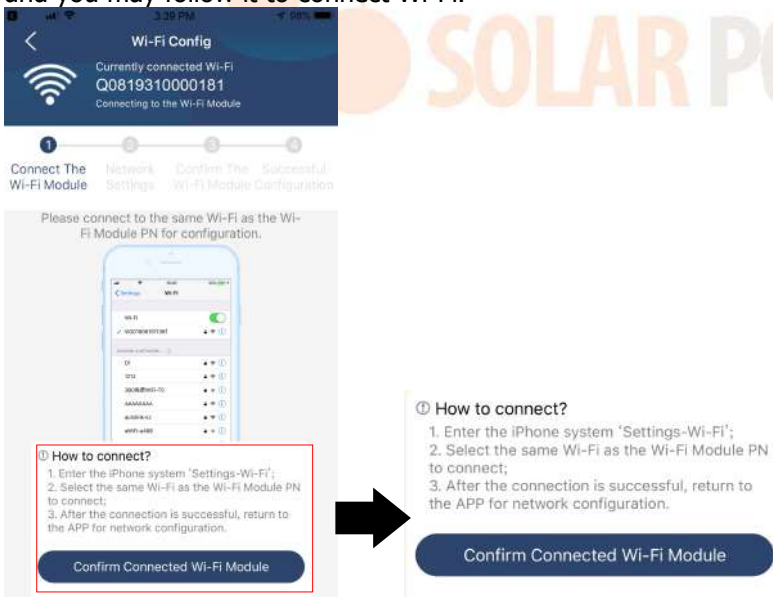

Enter the “Settings→Wi-Fi” and select connected Wi-Fi name. The connected Wi-Fi name is the same to your Wi-Fi PN number and enter default password “12345678”.

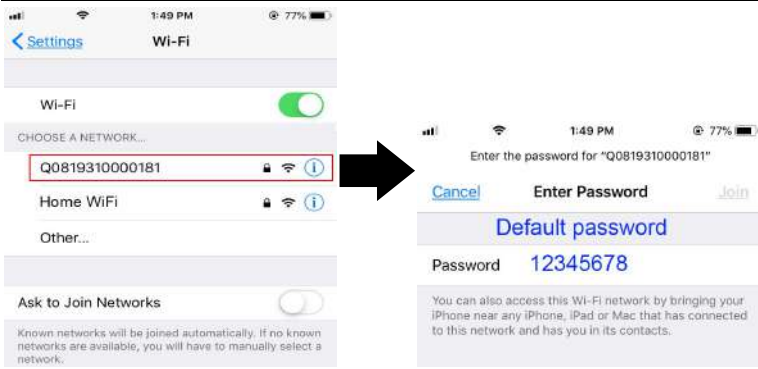

Then, return to SolarPower APP and tap “ **Confirm Connected Wi-Fi Module** ” button when Wi-Fi module is connected successfully.

### Step 3: Wi-Fi Network settings

Tap icon to select your local Wi-Fi router name (to access the internet) and enter password.

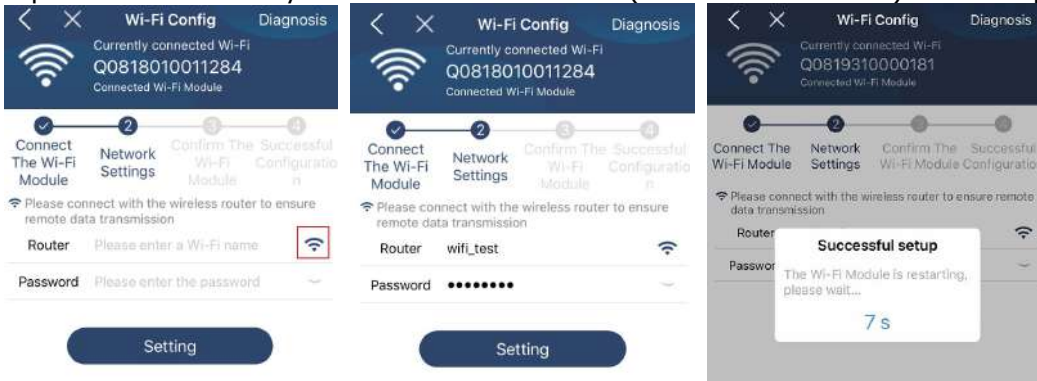

Step 4: Tap “Confirm” to complete the Wi-Fi configuration between the Wi-Fi module and the Internet.

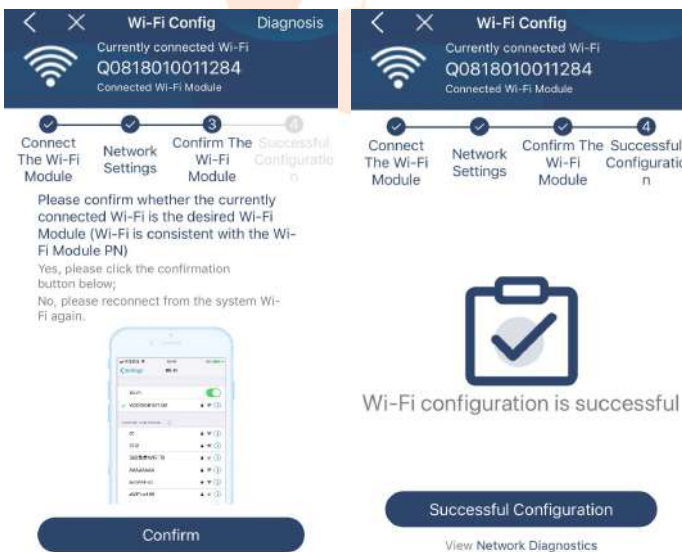

If the connection fails, please repeat Step 2 and 3.

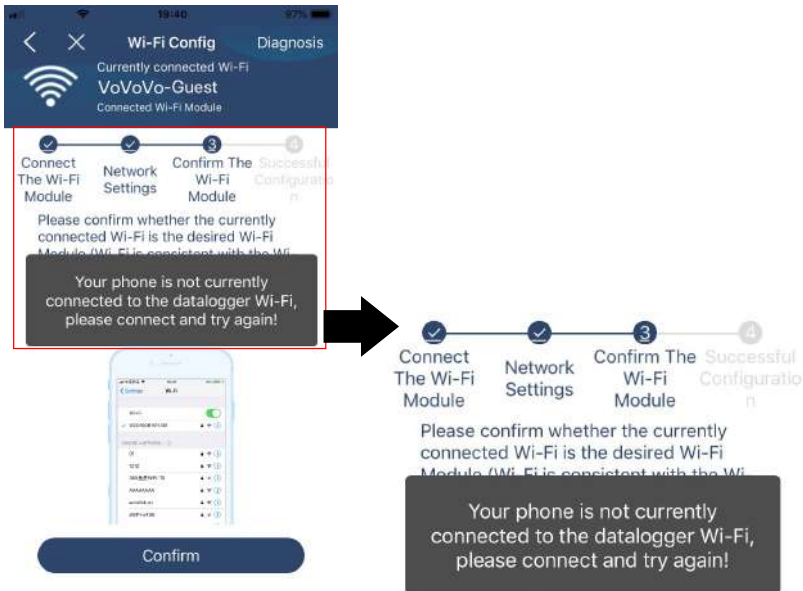

### Diagnose Function

If the module is not monitoring properly, please tap “Diagnosis” on the top right corner of the screen for further details. It will show repair suggestion. Please follow it to fix the problem. Then, repeat the steps in the chapter 4.2 to re-set network setting. After all setting, tap “Rediagnosis” to re-connect again.

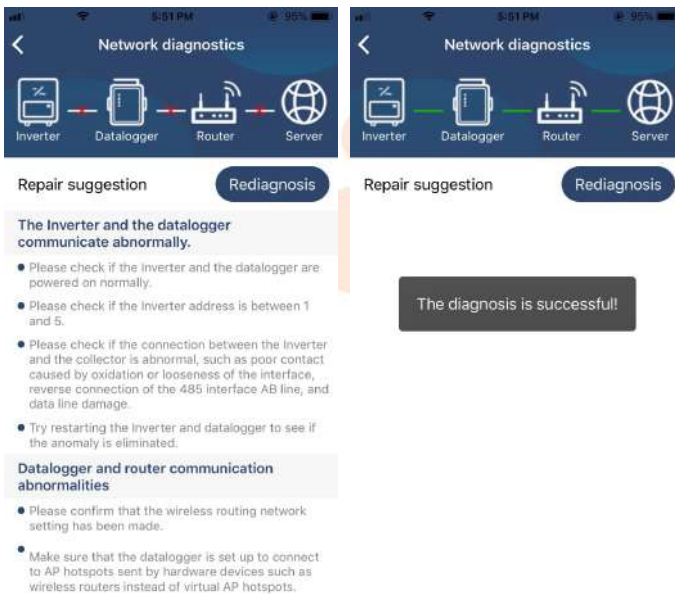

### 2-3. Login and APP Main Function

After finishing the registration and local Wi-Fi configuration, enter registered name and password to login. Note: Tick “Remember Me” for your login convenience afterwards.

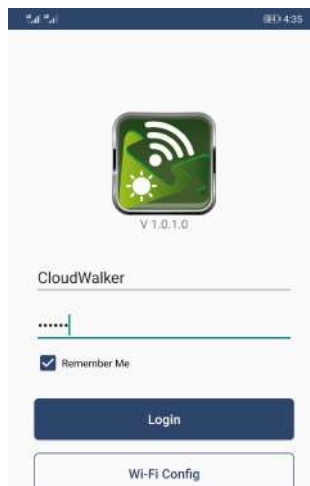



## Overview

After login is successfully, you can access "Overview" page to have overview of your monitoring devices, including overall operation situation and Energy information for Current power and Today power as below diagram.



## Devices

Tap the icon (located on the bottom) to enter Device List page. You can review all devices here by adding or deleting Wi-Fi Module in this page.

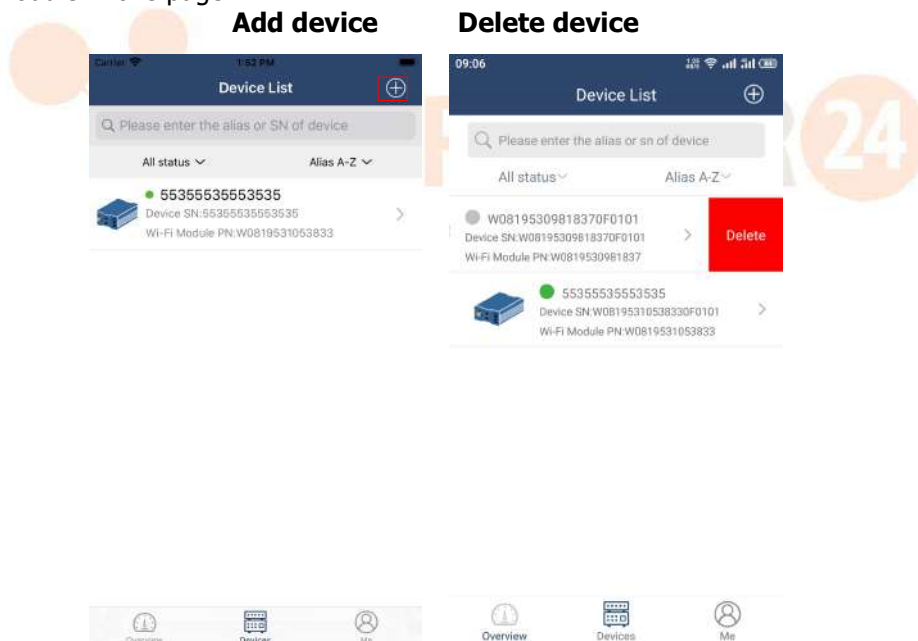

Tap icon on the top right corner and manually enter part number to add device. This part number label is pasted on the bottom of inverter. After entering part number, tap "Confirm" to add this device in the Device list.

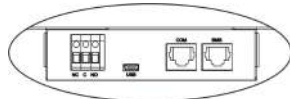
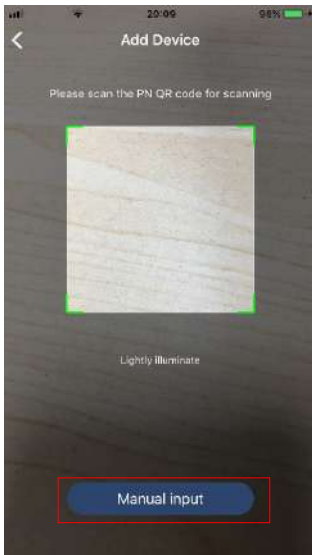

Part number label is pasted on the bottom of inverter.



For more information about Device List, please refer to the section 2.4.

## ME

In ME page, users can modify "My information", including **【User's Photo】**, **【Account security】**, **【Modify password】**, **【Clear cache】**, and **【Log-out】**, shown as below diagrams.

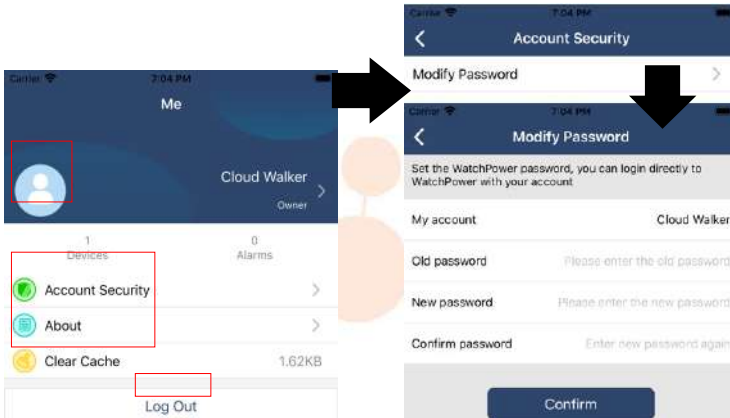

## 2-4. Device List

In Device List page, you can pull down to refresh the device information and then tap any device you want to check up for its real-time status and related information as well as to change parameter settings. Please refer to the parameter setting list.

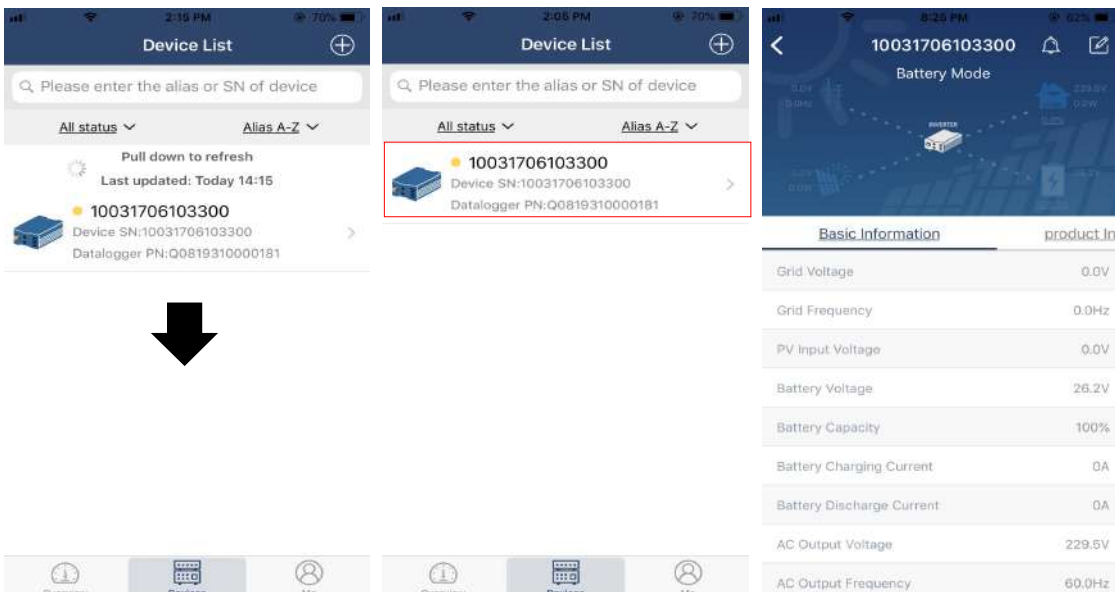

## Device Mode

On the top of screen, there is a dynamic power flow chart to show live operation. It contains five icons to present PV power, inverter, load, utility and battery. Based on your inverter model status, there will be **【Standby Mode】** , **【Line Mode】** , **【Battery Mode】** .

**【Standby Mode】** Inverter will not power the load until "ON" switch is pressed. Qualified utility or PV source can charge battery in standby mode.



**【Line Mode】** Inverter will power the load from the utility with or without PV charging. Qualified utility or PV source can charge battery.

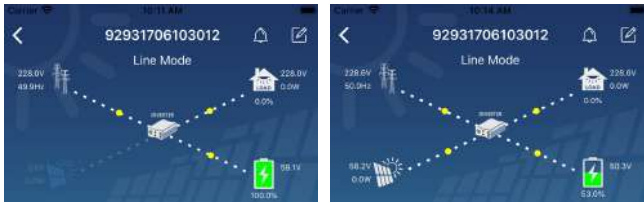

**【Battery Mode】** Inverter will power the load from the batter with or without PV charging. Only PV source can charge battery.



## Device Alarm and Name Modification

In this page, tap the icon on the top right corner to enter the device alarm page. Then, you can review alarm history and detailed information. Tap the icon on the top right corner, a blank input box will pop out. Then, you can edit the name for your device and tap "Confirm" to complete name modification.

Basic information	Product information	Rated info
Grid Voltage		0.0V
Grid Frequency		0.0Hz
PV Input Voltage		302.7V
Battery Voltage		28.3V
Battery Capacity		100%
Battery Charging Current		0A
Battery Discharge Current		0A
AC Output Voltage		230.2V

## Device Information Data

Users can check up **【Basic Information】** , **【Product Information】** , **【Rated information】** , **【History】** , and **【Wi-Fi Module Information】** by swiping left.



← Swipe left

**【Basic Information】** displays basic information of the inverter, including AC voltage, AC frequency, PV input voltage, Battery voltage, Battery capacity, Charging current, Output voltage, Output frequency, Output apparent power, Output active power and Load percent. Please slide up to see more basic information.

**【Production Information】** displays Model type (Inverter type), Main CPU version, Bluetooth CPU version and secondary CPU version.

**【Rated Information】** displays information of Nominal AC voltage, Nominal AC current, Rated battery voltage, Nominal output voltage, Nominal output frequency, Nominal output current, Nominal output apparent power and Nominal output active power. Please slide up to see more rated information.

**【History】** displays the record of unit information and setting timely.

**【Wi-Fi Module Information】** displays of Wi-Fi Module PN, status and firmware version.

### Parameter Setting

This page is to activate some features and set up parameters for inverters. Please be noted that the listing in "Parameter Setting" page in below diagram may differ from the models of monitored inverter. Here will briefly highlight some of it, **【Output Setting】**, **【Battery Parameter Setting】**, **【Enable/ Disable items】**, **【Other Settings】**, **【Restore to the defaults】** to illustrate.



There are three ways to modify setting and they vary according to each parameter.

- a) Listing options to change values by tapping one of it.
- b) Activate/Shut down functions by clicking "Enable" or "Disable" button.
- c) Changing values by clicking arrows or entering the numbers directly in the column.

Each function setting is saved by clicking "Set" button.

Please refer to below parameter setting list for an overall description and be noted that the available parameters may vary depending on different models. Please always see the original product manual for detailed setting instructions.

**Parameter setting list:**

Item		Description
Output setting	Output source priority	To configure load power source priority.
	AC input range	Input voltage range selection
	Output voltage	To set output voltage.
	Output frequency	To set output frequency.
Battery parameter setting	Battery Type	Select connected battery type
	Battery Cut-off Voltage	Set battery cut-off voltage
	Bulk Charging Voltage	Set battery bulk charging voltage
	Battery Float Voltage	Set battery floating charging voltage
	Max Charging Current	To configure total charging current for solar and utility chargers.
	Max AC Charging Current	Set maximum utility charging current
	Charging Source Priority	To configure charger source priority
	Back To Grid Voltage	Set battery voltage to stop discharging when grid is available
	Back To Discharge Voltage	Set battery voltage to stop charging when grid is available
Enable/Disable Functions	Overload Auto Restart	If disabled, the unit won't be restarted after overload occurs.
	Overload Temperature Auto Restart	If disabled, the unit won't be restarted after over-temperature fault is solved.
	Overload Bypass	If enabled, the unit will enter bypass mode when overload occurs.
	Beeps While Primary Source Interrupt	If enabled, buzzer will alarm when primary source is abnormal.
	Buzzer	If disabled, buzzer won't be on when alarm/fault occurred.
	Backlight	If disabled, LCD backlight will be off when panel button is not operated for 1 minute.
	LCD Screen Return To Default Display	If selected, no matter how users switch display screen, it will automatically return to default display screen (Input voltage /output voltage) after no button is pressed for 1 minute.
	Fault Code Record	If enabled, fault code will be recorded in the inverter when any fault happens.
	Solar Feed To	If selected, solar energy is allowed to feed to the grid.

	Grid	
Other Settings	Solar Supply Priority	Set solar power as priority to charge the battery or to power the load.
	Reset PV Energy Storage	If clicked, PV energy storage data will be reset.
	Start Time For Enable AC Charge Working	The setting range of start charging time for AC charger is from 00:00 to 23:00. The increment of each click is 1 hour.
	Ending Time For Enable AC Charge Working	The setting range of stop charging time for AC charger is from 00:00 to 23:00. The increment of each click is 1 hour.
	Scheduled Time For AC Output On	The setting range of scheduled time for AC output on is from 00:00 to 23:00. The increment of each click is 1 hour.
	Scheduled Time For AC Output Off	The setting range of scheduled time for AC output off is from 00:00 to 23:00. The increment of each click is 1 hour.
	Country Customized Regulations	Select inverter installed area to meet local regulation.
	Set Date Time	Set date time.
Restore to the default	This function is to restore all settings back to default settings.	

