



User Manual

SP24 ESS 810 OFF GRID ENERGY STORAGE SYSTEM 8KW AND 5.16KW LIFEP04 BATTERY

Table of Contents

ABOUT THIS MANUAL	3
Purpose.....	3
Scope.....	3
SAFETY INSTRUCTIONS.....	3
INTRODUCTION	5
Features.....	5
Basic System Architecture	5
Product Overview.....	6
INSTALLATION	7
Unpacking and Inspection	7
Mounting the Unit.....	9
Battery Connection	18
AC Input/Output Connection.....	21
PV Connection	22
Final Assembly.....	26
Communication Connection.....	27
Dry Contact Signal.....	29
OPERATION.....	30
Power ON/OFF	30
Operation and Display Panel.....	30
LCD Display Icons	31
LCD Setting.....	33
LCD Display	49
Operating Mode Description	58
Faults Reference Code	63
Warning Indicator.....	64
CLEARANCE AND MAINTENANCE FOR ANTI-DUST KIT	65
Overview	65
Clearance and Maintenance.....	65
SPECIFICATIONS.....	66
Table 1 Line Mode Specifications	66
Table 2 Inverter Mode Specifications	67
Table 3 Charge Mode Specifications.....	68
Table 4 General Specifications.....	70
TROUBLE SHOOTING	71
Appendix I: Parallel function	72

Appendix II: BMS Communication Installation.....	83
Appendix III: The Wi-Fi Operation Guide in Remote Panel	87



ABOUT THIS MANUAL

Purpose

This manual describes the assembly, installation, operation and troubleshooting of this unit. Please read this manual carefully before installations and operations. Keep this manual for future reference.

Scope

This manual provides safety and installation guidelines as well as information on tools and wiring.

SAFETY INSTRUCTIONS

⚠ WARNING: This chapter contains important safety and operating instructions. Read and keep this manual for future reference.

1. Before using the unit, read all instructions and cautionary markings on the unit, the batteries and all appropriate sections of this manual.
2. **CAUTION** --To reduce risk of injury, charge only deep-cycle lead acid type rechargeable batteries. Other types of batteries may burst, causing personal injury and damage.
3. Do not disassemble the unit. Take it to a qualified service center when service or repair is required. Incorrect re-assembly may result in a risk of electric shock or fire.
4. To reduce risk of electric shock, disconnect all wirings before attempting any maintenance or cleaning. Turning off the unit will not reduce this risk.
5. **CAUTION** – Only qualified personnel can install this device with battery.
6. **NEVER** charge a frozen battery.
7. For optimum operation of this inverter/charger, please follow required spec to select appropriate cable size. It's very important to correctly operate this inverter/charger.
8. Be very cautious when working with metal tools on or around batteries. A potential risk exists to drop a tool to spark or short circuit batteries or other electrical parts and could cause an explosion.
9. Please strictly follow installation procedure when you want to disconnect AC or DC terminals. Please refer to INSTALLATION section of this manual for the details.
10. Fuses are provided as over-current protection for the battery supply.
11. **GROUNDING INSTRUCTIONS** -This inverter/charger should be connected to a permanent grounded wiring system. Be sure to comply with local requirements and regulation to install this inverter.
12. **NEVER** cause AC output and DC input short circuited. Do NOT connect to the mains when DC input short circuits.
13. **Warning!!** Only qualified service persons are able to service this device. If errors still persist after following troubleshooting table, please send this inverter/charger back to local dealer or service center for maintenance.
14. **WARNING:** Because this inverter is non-isolated, only three types of PV modules are acceptable: single crystalline, poly crystalline with class A-rated and CIGS modules. To avoid any malfunction, do not connect any PV modules with possible current leakage to the inverter. For example, grounded PV modules will cause current leakage to the inverter. When using CIGS modules, please be sure NO grounding.
15. **CAUTION:** It's required to use PV junction box with surge protection. Otherwise, it will cause damage

on inverter when lightning occurs on PV modules.



INTRODUCTION

This energy storage system can provide power to connected loads by utilizing PV power, utility power and battery power and store surplus energy generated from PV solar modules for use when needed. When the sun has set, energy demand is high, or there is a black-out, you can use the energy stored in this system to meet your energy needs at no extra cost. In addition, this energy storage system helps you pursue the goal of energy self-consumption and ultimately energy-independence.

Features

- Pure sine wave inverter
- Customizable status LED ring with RGB lights
- Touchable button with 5" colored LCD
- Built-in Wi-Fi for mobile monitoring (APP is required)
- Supports USB On-the-Go function
- Built-in anti-dusk kit
- Reserved communication ports for BMS (RS485, CAN-BUS, RS232)
- Configurable input voltage ranges for home appliances and personal computers via LCD control panel
- Configurable output usage timer and prioritization
- Configurable charger source priority via LCD control panel
- Configurable battery charging current based on applications via LCD control panel
- Compatible to utility mains or generator power

Basic System Architecture

The following illustration shows basic application for this unit. It also required the following devices to have a complete running system:

- Generator or Utility mains.
- PV modules

Consult with your system integrator for other possible system architectures depending on your requirements.

This inverter can power various appliances in home or office environment, including motor-type appliances such as tube light, fan, refrigerator and air conditioners.

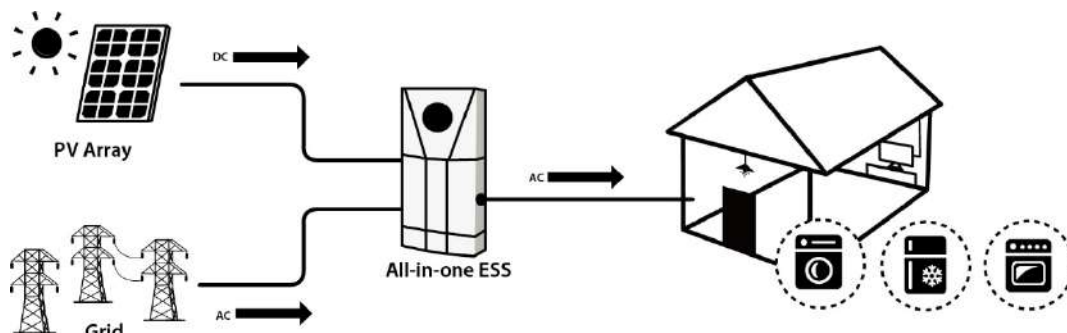
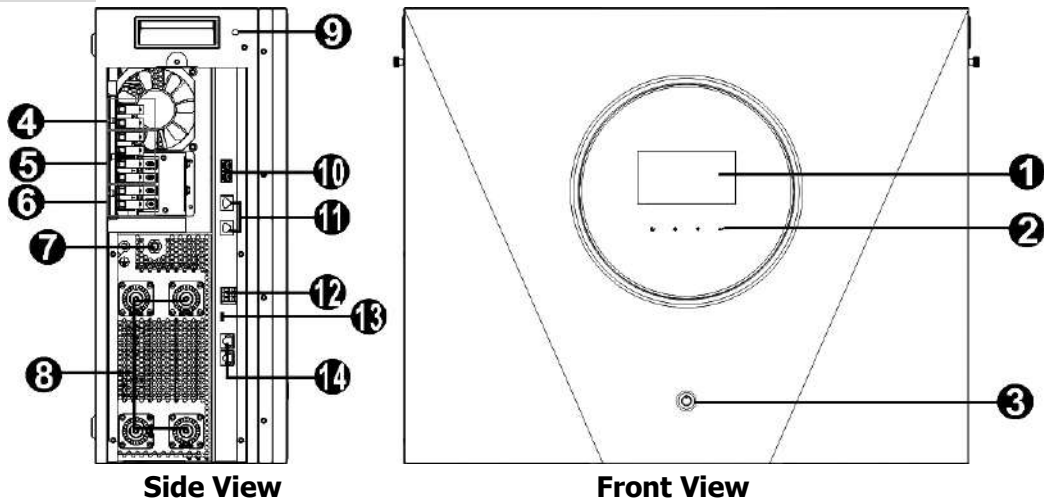

Figure 1 Energy storage system overview

Product Overview

Inverter Module



NOTE: For parallel installation and operation, please check *Appendix I*.

- | | |
|-------------------------------|---------------------------------|
| 1. LCD display | 8. Battery connectors |
| 2. Touchable function buttons | 9. WiFi antenna |
| 3. Power on/off button | 10. Current sharing port |
| 4. PV terminals | 11. Parallel communication port |
| 5. AC output | 12. Dry contact |
| 6. AC input | 13. USB port |
| 7. AC breaker | 14. BMS com. port |

Battery Module

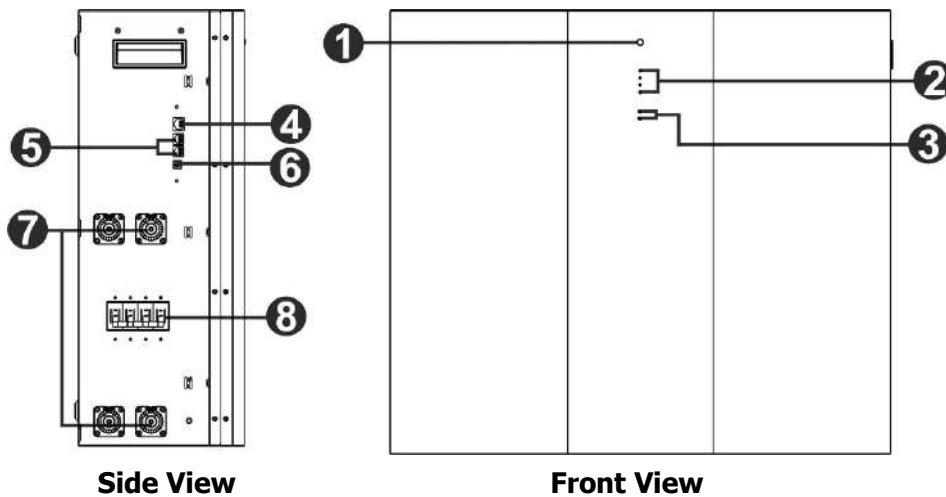

- | | |
|--------------------------------|-----------------------|
| 1. Power on/off button | 5. Extension port |
| 2. Battery capacity indicators | 6. ID switch |
| 3. Battery status indicators | 7. Battery connectors |
| 4. RS485 port (BMS com. port) | 8. DC breaker |











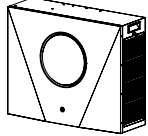
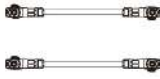

INSTALLATION

Unpacking and Inspection

Before installation, please inspect the unit. Be sure that nothing inside the package is damaged. You should have received the following items inside of package:







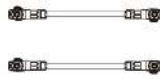
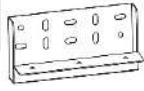
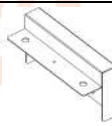

Inverter Package

You should receive the following items inside of package:

 Inverter module	 Battery cable #B1-I	 Software CD	 Manual	 WiFi antenna	 BMS cable
 Mounting brackets	 Flat-head screws x 3	 Mounting screws x 4	 Nylon-Plug x 4	 Bracket cover	 Round-head screws x 8
 Parallel cable	 Share current cable				





Battery Module Package

You should receive the following items inside of package:

 Battery module	 Battery cable #B-B	 Top-bracket	 Bottom-bracket
 L-shape plate x 2	 Round-head screws X 4	 Flat-head screws x 7	 Mounting screws x 8
 Nylon-Plug x 8	 RJ11 cable	 RJ11 signal cable	 Ball screws X 2

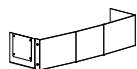
Optional Accessory

There are some optional accessories for purchase separately.

 Wiring cover	 Thumb screws x 4	 Battery cable #BI-2	 Battery cable #B2-B
---	---	--	--

Wiring cover (optional)

There is a separate part called "wiring cover". If connecting parallel battery modules, you may purchase "wiring cover" separately to cover all cables on the bottom.

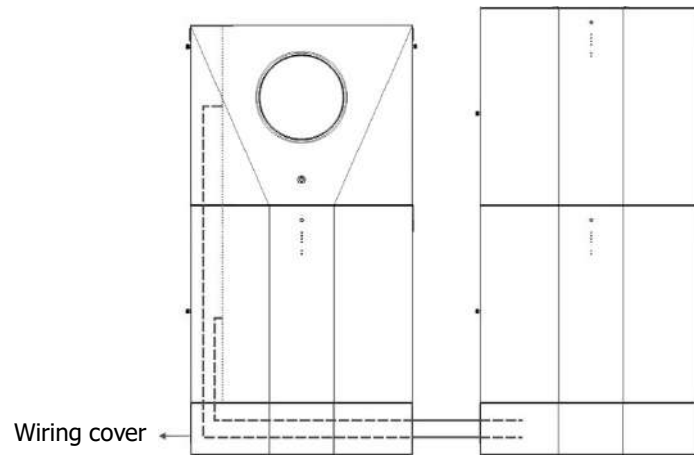

Mounting the Unit

Selecting Mounting Location

Consider the following points to install the energy storage system:

- Do not mount the unit on flammable construction materials.
- Mount on a solid surface
- This unit might make noises during operation which may be perceived as a nuisance in a living area.
- Install this unit at eye level in order to allow the readability of LCD display at all times.
- For proper air circulation to dissipate heat and further maintenance, allow a clearance of approx. 75 cm to the sides of the unit.
- To avoid battery falling, be sure to leave around 80~100cm distance between battery modules installed in parallel.
- Dusty conditions on the unit may impair the performance of this inverter.
- The ambient temperature should be between 0°C and 40°C and relative humidity should be between 5% and 85% to ensure optimal operation.
- The recommended installation is vertical adherence.
- For proper operation of this unit, please use appropriate cables for grid connection.
- The pollution degree of the energy storage system is PD2. Select an appropriate mounting location. Install the inverter and battery modules in a protected area that is dry, free of excessive dust and with adequate air flow. Do NOT operate it in the place where the temperature and humidity is beyond the specific limits. (Please check the specs for the limitations.)
- The inverter should be installed in the position where the disconnection means is easily accessible.
- This unit is designed with IP20 protection for indoor applications only.
- Regularly clean the fan filter.

Mounting the Unit

WARNING!! Remember that this inverter is heavy so please be careful when removing it from the package.

Installation to the wall should be fixed with proper screws. After that, the device should be bolted on securely.

The unit can only operate in a CLOSED ELECTRICAL OPERATING AREA. Only service personnel can enter this area.

WARNING!! FIRE HAZARD.

SUITABLE FOR MOUNTING ON CONCRETE OR OTHER NON-COMBUSTIBLE SURFACE ONLY.

This energy storage system should be installed battery modules first on the bottom and then inverter module on the top.

Step 1: Use Ø10mm drill to drill holes at a depth of 50mm. The distance between holes is as follows. Insert the nylon-plug after drilling is completed.

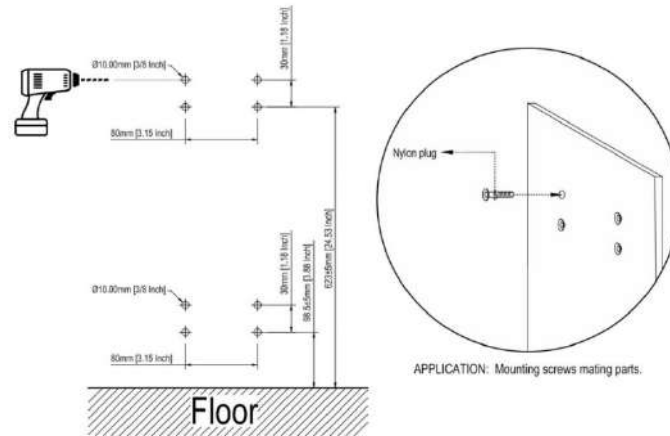

Step 2: It's required to use bubble level to adjust the bottom-bracket to center first. Then, mount the bracket to the wall.

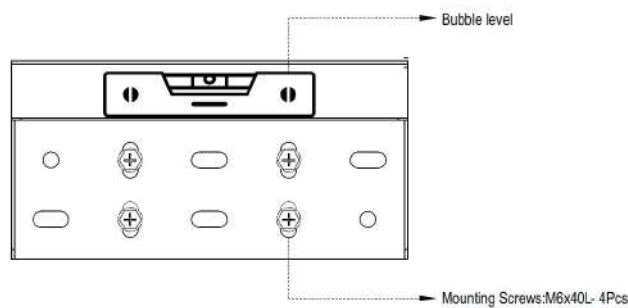

Step 3: Remove side cover of battery module first.

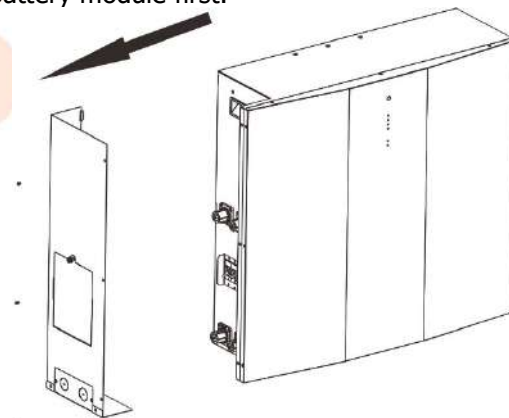

Step 4: Fix top-bracket of the battery module separately with three flat-head screws as shown in the chart.

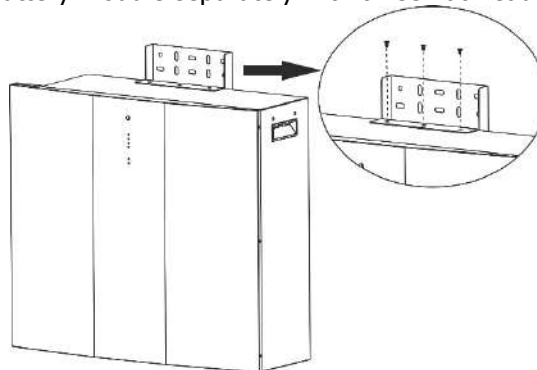

Step 5: Fix ball-screws on the bottom of battery module as shown in below chart.

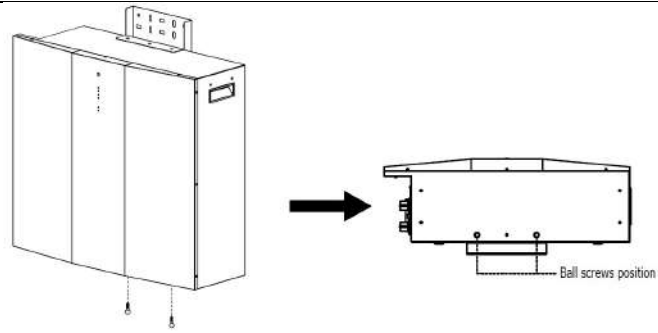

Step 6: Take bottom-bracket and align ball screws with the bracket holes.

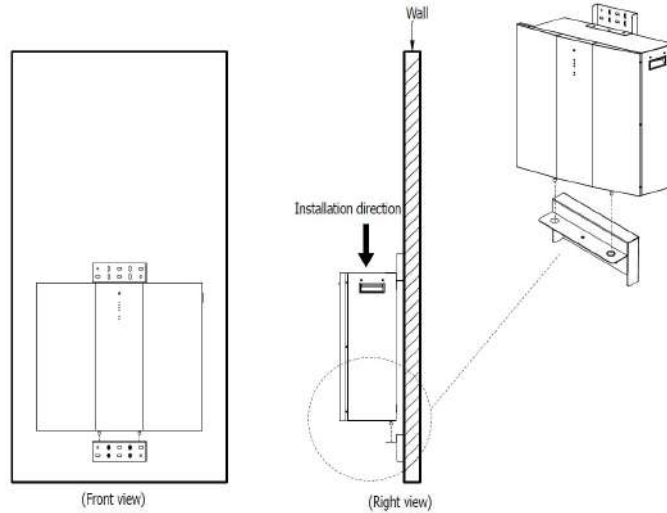

Step 7: Mount the top-bracket with four screws on the wall.

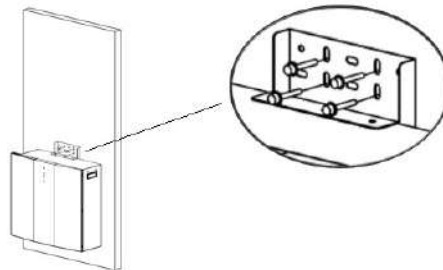

Step 8: Use $\varnothing 10\text{mm}$ drill to drill holes at a depth of 50mm. The distance between holes is as follows. Install the nylon-plug after drilling is completed.

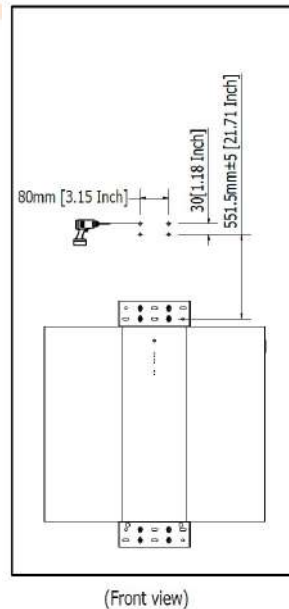

Step 9: Fix two L-shape plates on the bottom of the second battery module with four flat-head screws.

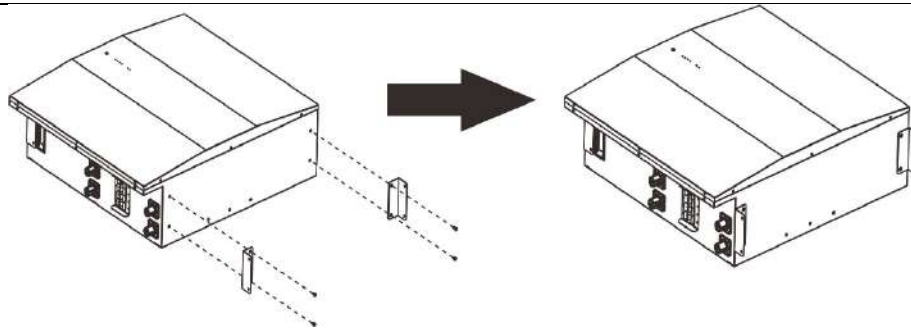

Step 10: Put the second battery module on the top of first battery module and fix two L-shape plates to the first battery module with four round-head screws.
Then, fix the second battery module to the wall with four mounting screws.

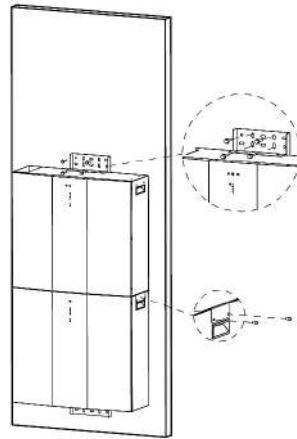

Step 11: Use $\varnothing 10\text{mm}$ to drill holes at a depth of 50mm at the wall and insert nylon-plugs inside of each hole.

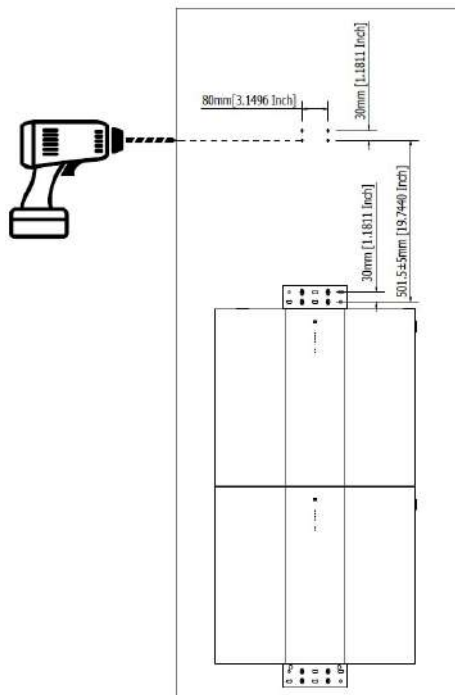

Step 12: Fix two L-shape plates on the bottom of the inverter module with four flat-head screws and also fix mounting bracket on the top of the inverter with two flat-head screws.

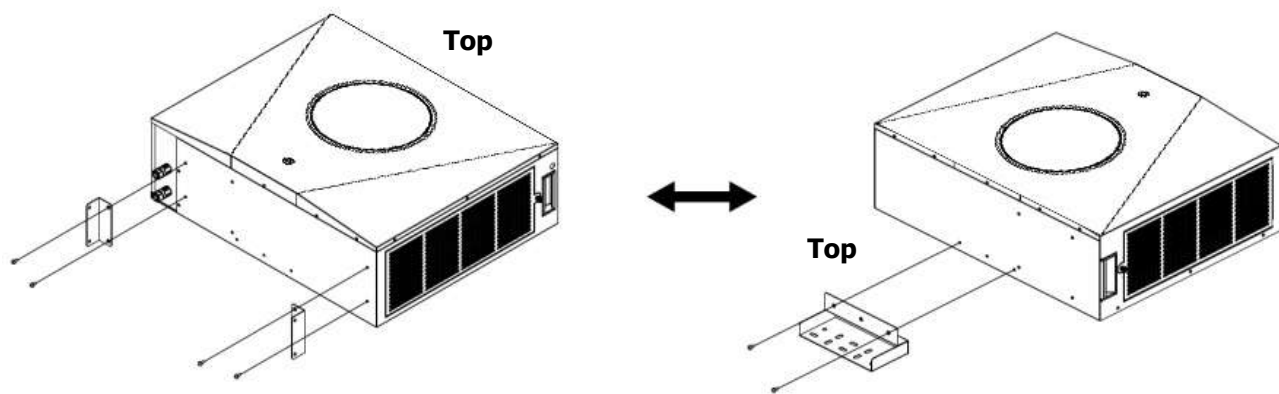

Step 13: Put the inverter module on the top of second battery module. Fix mounting bracket with four mounting screws to the wall. Then, fix two L-shape plates to the second battery module with four round-head screws.

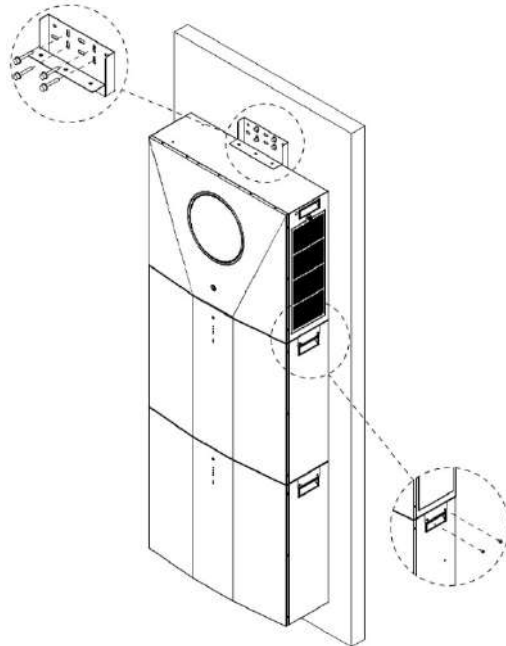

Step 14: Fix bracket cover to the mounting bracket with flat-head screws.

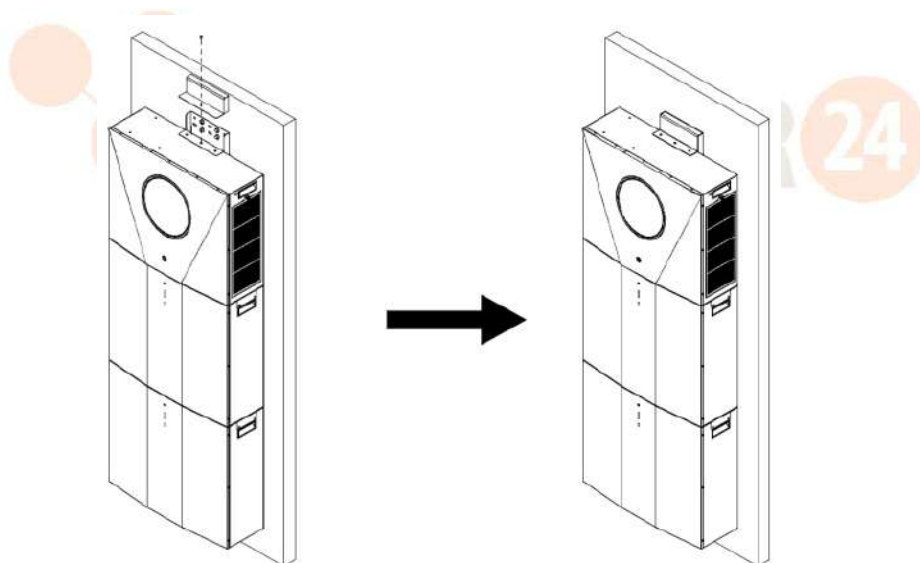

Preparation

Before connecting all wires, be sure to take off wiring cover by removing four screws and one thumb screw. Refer to below chart for the details.

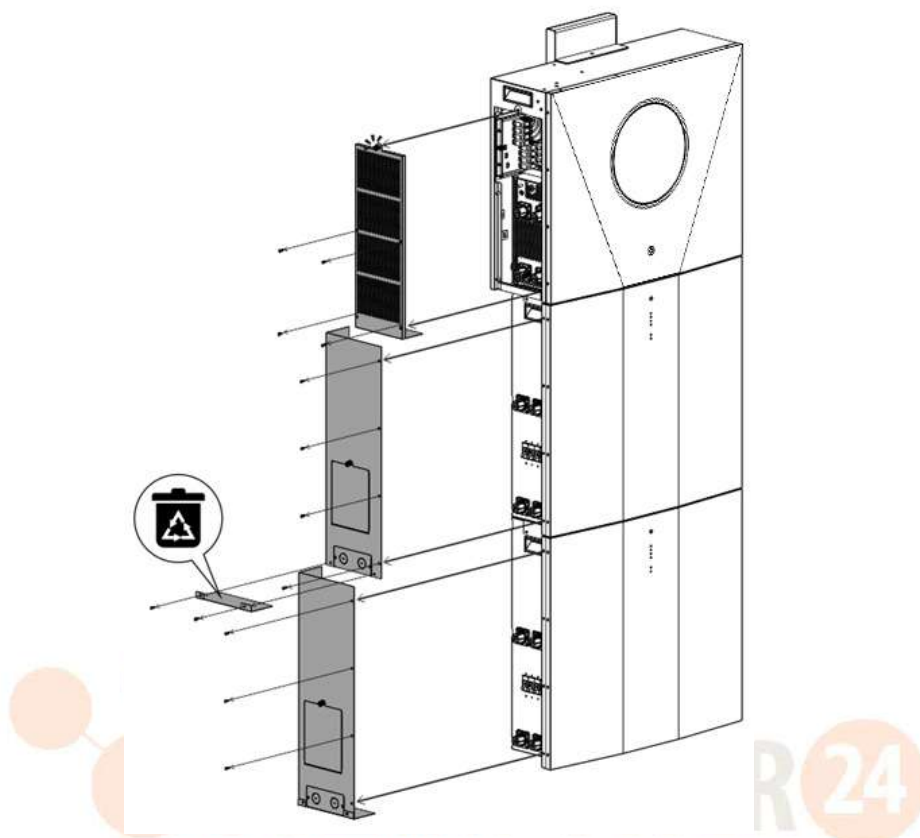

Battery Connection

CAUTION: Before connecting to battery modules, please **disconnect** the DC breaker between inverter and batteries.

Single battery connection

Step 1: Use supplied two battery cables #B-B (supplied in battery module package). Use another two battery cables #B1-I (supplied in inverter package). Follow the polarity of battery printed near the battery terminal! Simply plug battery cable to battery terminals on inverter module and battery module as shown in the chart.

ORANGE cable to the positive terminal (+)

BLACK cable to the negative terminal (-)

WARNING! Wrong connections may damage the unit permanently.

Step 2: Make sure the wires are securely connected.

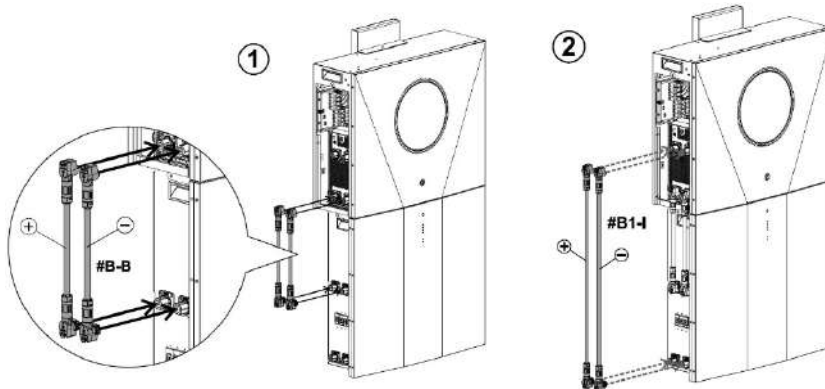

Step 3: Insert the supplied RJ45 cable (from inverter module package) into the BMS port on the inverter module. The other end connects to RS485 port on the first battery module.

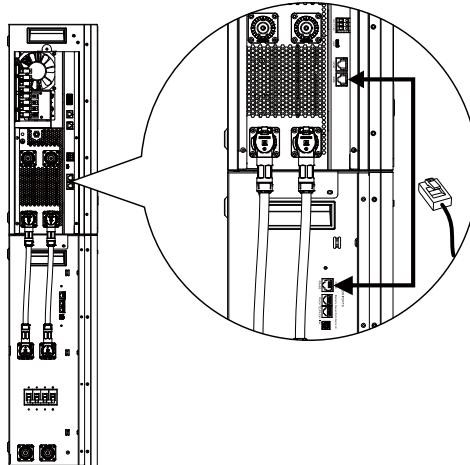

Step 4: Insert the supplied RJ11 signal cable (from battery module package) into one of the extension port (□ or □) on the battery module.

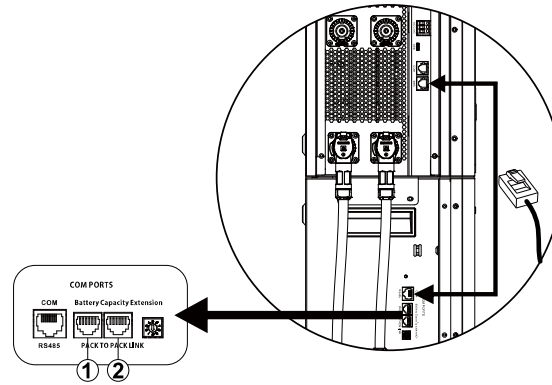

Multiple battery connection

If there are more battery modules to connect, please follow below steps to connect batteries.

Step 1: Use supplied battery cable #B-B (inside of battery module package) to connect the first battery module and purchase another battery cable #BI-2 to connect second battery module as shown below chart.

Follow the polarity of battery printed near the battery terminal!

ORANGE cable to the positive terminal (+)

BLACK cable to the negative terminal (-)

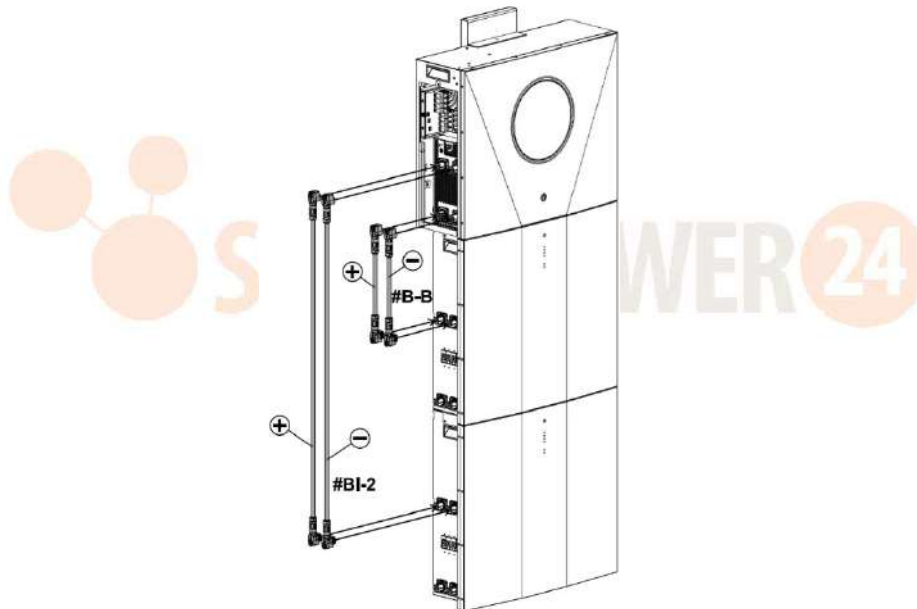

Step 2: Insert the supplied RJ11 cable (from battery module package) into the extension port on the first battery module. The other end connects to extension port on the second battery module. Refer below chart for the details.

Step 3: After all wiring installation is complete, set up ID for each battery module. The ID code for each battery module MUST be unique. Not the same number for 2 battery modules in parallel system. Refer below chart for the details.

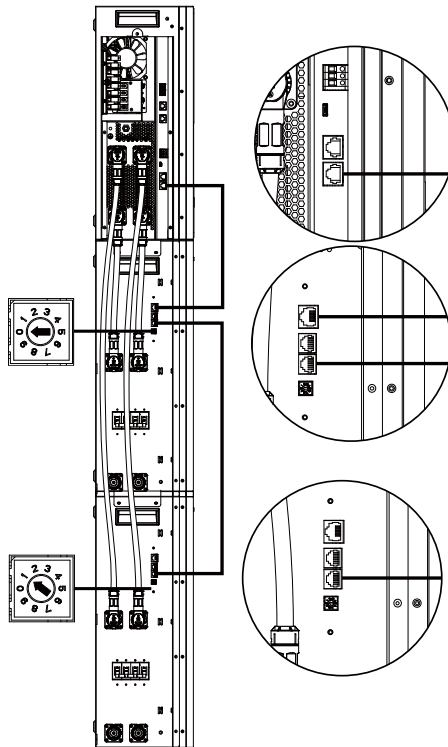

If there is more battery module installed in parallel, please follow below to connect battery module in parallel.

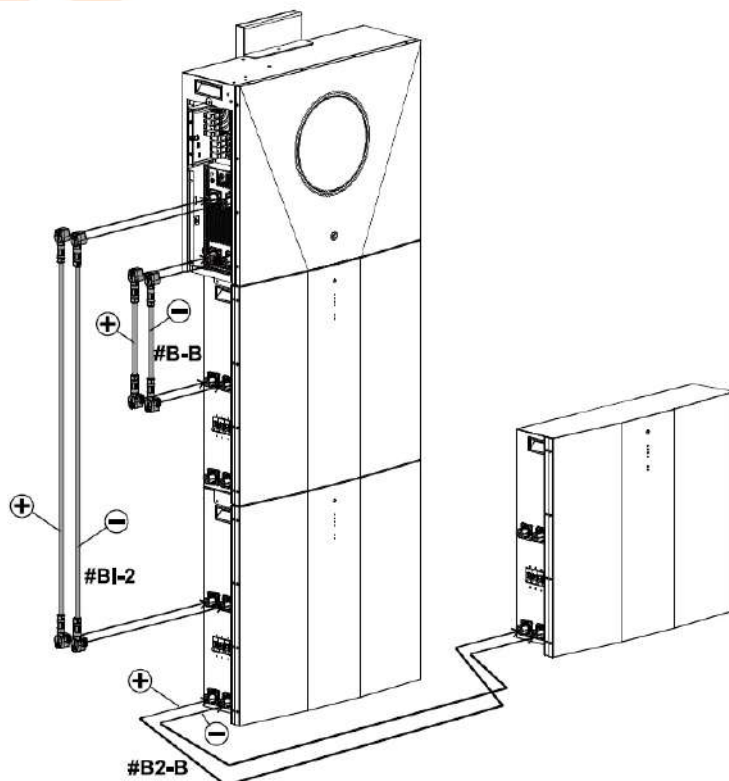

CAUTION: To avoid battery falling, be sure to leave around 75cm distance between battery modules installed in parallel.

AC Input/Output Connection

CAUTION: Before connecting to AC input power source, please install a **separate** AC circuit breaker between inverter module and AC input power source. This will ensure the inverter can be securely disconnected during maintenance and fully protected from over current of AC input.

CAUTION!! There are two terminal blocks with "IN" and "OUT" markings. Please do NOT mis-connect input and output connectors.

WARNING! All wiring must be performed by a qualified personnel.

WARNING! For safety and efficiency, it's very important to use appropriate cables for AC input and output connection. To reduce risk of injury, please use the proper cable size recommended below.

Suggested cable requirement for AC wire:

Gauge	Torque Value
8 AWG	1.4~ 1.6Nm

Please follow below steps to implement AC input/output connection:

Step 1: Before making AC input/output connection, be sure to unscrew all bus terminals.

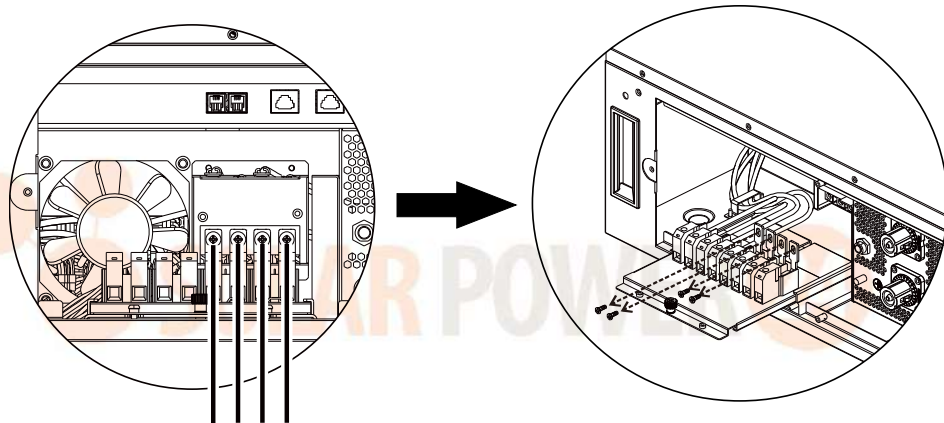

Unscrew all bus terminals

Step 2: Pull out the terminal tray and take off thumb screw.

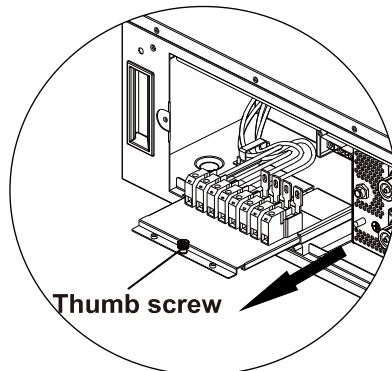

Thumb screw

Step 3: Remove insulation sleeve 10 mm from four conductors and shorten phase L and neutral conductor N for 3 mm. Refer to chart 1.

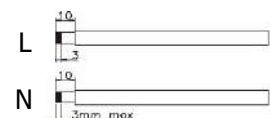
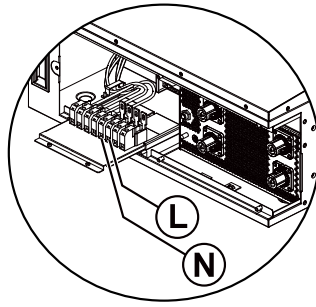

Chart 1

Step 4: Insert AC output wires according to polarities indicated on terminal block and tighten the terminal screws.

L→LINE (brown or black)

N→Neutral (blue)



WARNING:

Be sure that AC power source is disconnected before attempting to hardwire it to the unit.

Step 5: Insert AC input wires according to polarities indicated on terminal block and tighten terminal screws. Be sure to connect PE protective conductor (\perp) first.

L → **LINE (brown or black)**

\perp → **Ground (yellow-green)**

N → **Neutral (blue)**

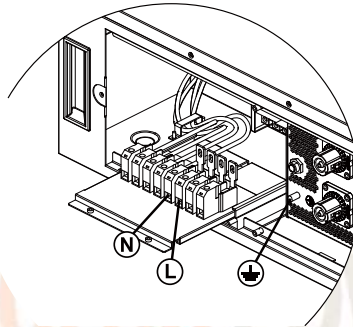

Step 6: Make sure the wires are securely connected. The reference tightening torque is 5N.m.

Step 7: After wires are all connected well, screw back thumb screw and push back the terminal tray to original position.

CAUTION: Important

Be sure to connect AC wires with correct polarity. If L and N wires are connected reversely, it may cause utility short-circuited when these inverters are worked in parallel operation.

CAUTION:

Appliances such as air conditioner requires at least 2~3 minutes to restart because it's required to have enough time to balance refrigerant gas inside of circuits. If a power shortage occurs and recovers in a short time, it will cause damage to your connected appliances. To prevent this kind of damage, please check manufacturer of air conditioner if it's equipped with time-delay function before installation. Otherwise, this inverter/charger will be trigger overload fault and cut off output to protect your appliance but sometimes it still causes internal damage to the air conditioner.

PV Connection

CAUTION: Before connecting to PV modules, please install **separately** DC circuit breakers between inverter and PV modules.

WARNING! It's very important for system safety and efficient operation to use appropriate cable for PV module connection. To reduce risk of injury, please use the proper recommended cable size shown below.

Wire Size	Cable (mm ²)	Torque value (max)
1 x 12AWG	4	1.2 Nm

WARNING: Because this inverter is non-isolated, only two types of PV modules are accepted, single crystalline, poly crystalline with class A-rated and CIGS modules. To avoid any malfunctions, do not connect any PV modules with possible current leakage to the inverter. For example, grounded PV modules will cause current leakage to the inverter. When using CIGS modules, please be sure NO grounding connection.

CAUTION: It's requested to use PV junction box with surge protection. Otherwise, it will cause damage on inverter when lightning occurs on PV modules.



PV Module Selection:

When selecting proper PV modules, please be sure to consider the following parameters:

1. Open circuit Voltage (Voc) of PV modules not to exceeds maximum PV array open circuit voltage of the inverter.
2. Open circuit Voltage (Voc) of PV modules should be higher than the start-up voltage.

Max. PV Array Power	8000W
Max. PV Array Open Circuit Voltage	500Vdc
PV Array MPPT Voltage Range	90Vdc~450Vdc
Start-up Voltage	80Vdc +/- 5Vdc

Recommended solar panel configuration:

Solar Panel Spec. (reference)	SOLAR INPUT 1	SOLAR INPUT 2	Q'ty of panels	Total Input Power
	Min in series: 4pcs, per input Max. in series: 12pcs, per input			
- 250Wp	4pcs in series	x	4pcs	1000W
- Vmp: 30.7Vdc	x	4pcs in series	4pcs	1000W
- Imp: 8.3A	12pcs in series	x	12pcs	3000W
- Voc: 37.7Vdc	x	12pcs in series	12pcs	3000W
- Isc: 8.4A	6pcs in series	6pcs in series	12pcs	3000W
- Cells: 60	6pcs in series, 2 strings	x	12pcs	3000W
	x	6pcs in series, 2 strings	12pcs	3000W
	8pcs in series, 2 strings	x	16pcs	4000W
	x	8pcs in series, 2 strings	16pcs	4000W
	9pcs in series, 1 string	9pcs in series, 1 string	18pcs	4500W
	10pcs in series, 1 string	10pcs in series, 1 string	20pcs	5000W
	12pcs in series, 1 string	12pcs in series, 1 string	24pcs	6000W
	6pcs in series, 2 strings	6pcs in series, 2 strings	24pcs	6000W
	7pcs in series, 2 strings	7pcs in series, 2 strings	28pcs	7000W
	8pcs in series, 2 strings	8pcs in series, 2 strings	32pcs	8000W

PV Module Wire Connection

Please take the following to implement PV module connection:

1. Remove insulation sleeve for about 7 mm on your positive and negative wires.
2. We recommend using bootlace ferrules on the wires for optimal performance.
3. Check polarities of wire connections from PV modules to PV input screw terminals.

Connect your wires as illustrated below.

Recommended tool: 4mm blade screwdriver



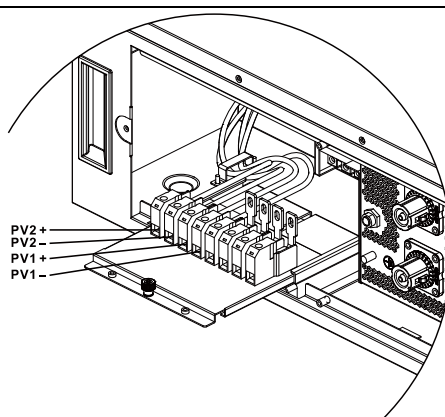

Final Assembly

After connecting all wirings, put side covers back to original positions by fixing screws as shown below.

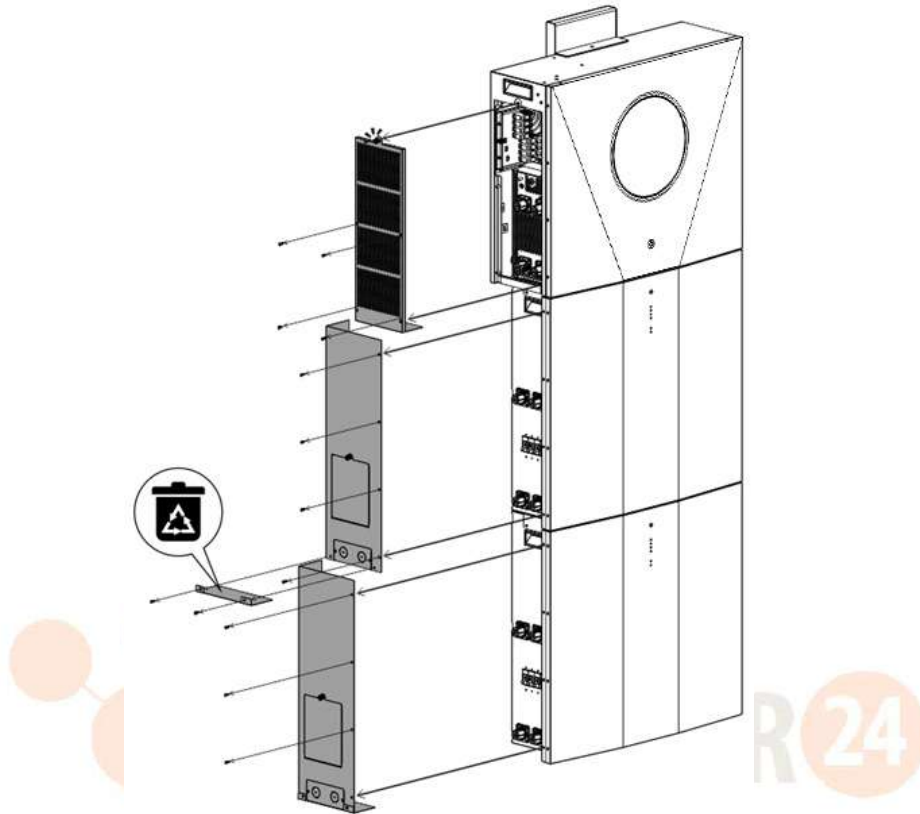

If wiring cover is purchased separately, be sure to screw four thumb screws under the bottom of the battery module first. Then, push the two fixing feet from two sides of the battery module until they are locked with thumb screws. At last, install the cover to fixing feet with four screws as shown below chart.

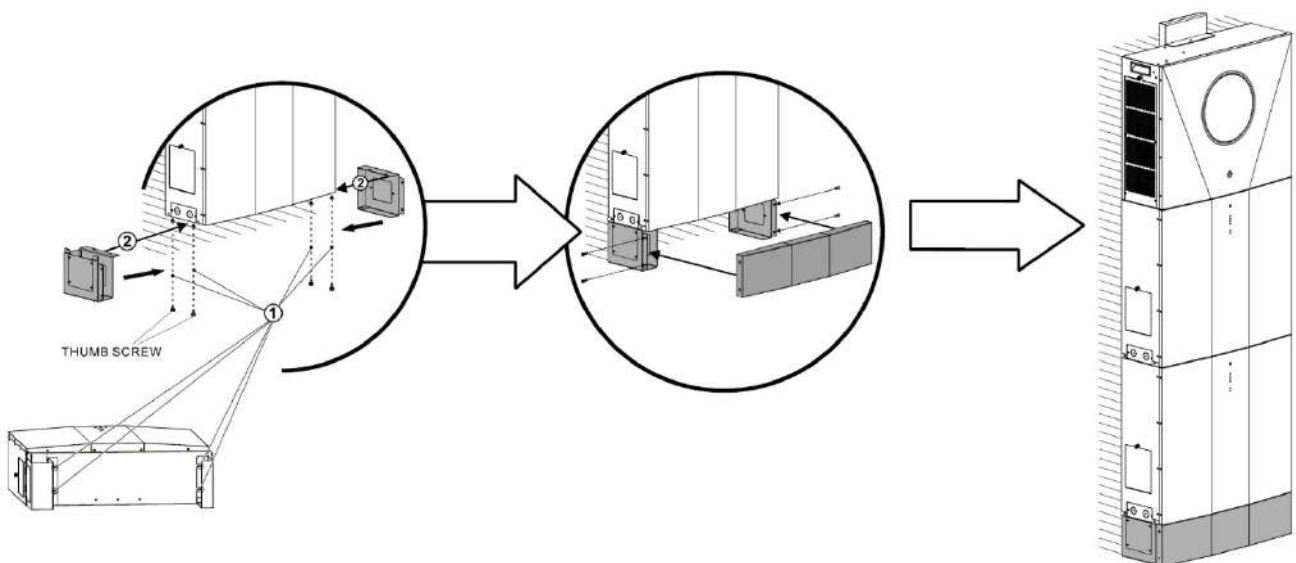

Communication Connection

Follow below chart to connect all communication wiring.

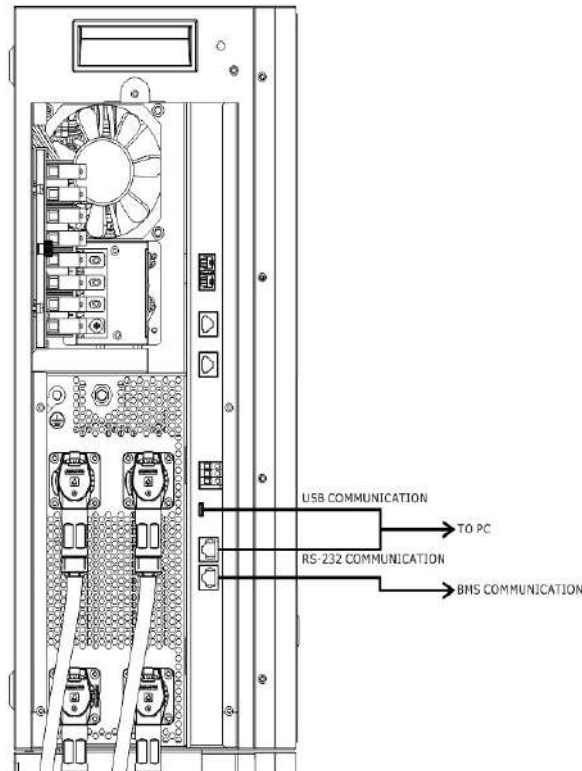

Serial Connection

Please use the supplied serial cable to connect between the inverter and your PC. Install the monitoring software from the bundled CD and follow the on-screen instructions to complete your installation. For detailed software operation, refer to the software user manual on the bundled CD.

Wi-Fi Connection

This unit is equipped with a Wi-Fi transmitter. Wi-Fi transmitter can enable wireless communication between off-grid inverters and monitoring platform. Users can access and control the monitored inverter with downloaded APP. You may find "WatchPower" app from the Apple® Store or "WatchPower Wi-Fi" in Google® Play Store. All data loggers and parameters are saved in iCloud. For quick installation and operation, please check Appendix III.



BMS Communication Connection

Please refer to Appendix II - BMS Communication Installation for details.



Dry Contact Signal

There is one dry contact (3A/250VAC) available on the rear panel. It could be used to deliver signal to external device when battery voltage reaches warning level.

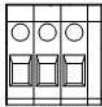
Unit Status	Condition			Dry contact port: 	
				NC & C	NO & C
Power Off	Unit is off and no output is powered.			Close	Open
Power On	Output is powered from Battery power or Solar energy.	Program 01 set as USB (utility first) or SUB (solar first)	Battery SOC < Low DC warning SOC	Open	Close
			Battery SOC > Setting value in Program 13	Close	Open
		Program 01 is set as SBU (SBU priority)	Battery SOC < Setting value in Program 12	Open	Close
			Battery SOC > Setting value in Program 13	Close	Open

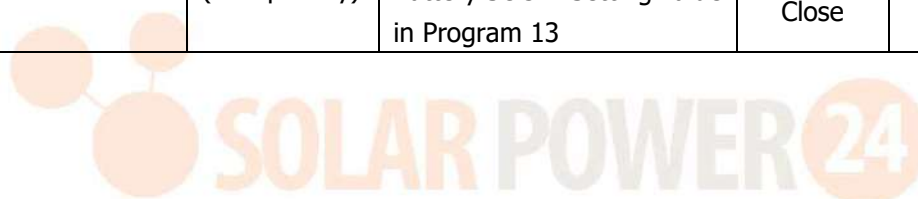

OPERATION

Power ON/OFF

Once the unit has been properly installed and the batteries are connected well, simply press power switch to turn on the unit.

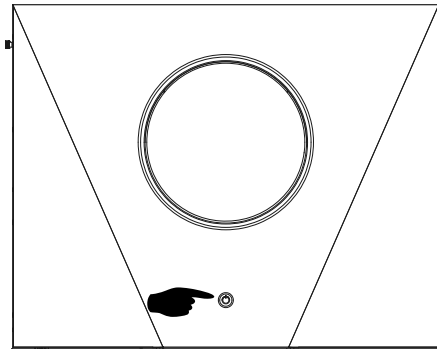

Operation and Display Panel

The operation and the LCD module, shown in the chart below, includes four touchable function keys and a LCD display to indicate the operating status and input/output power information.

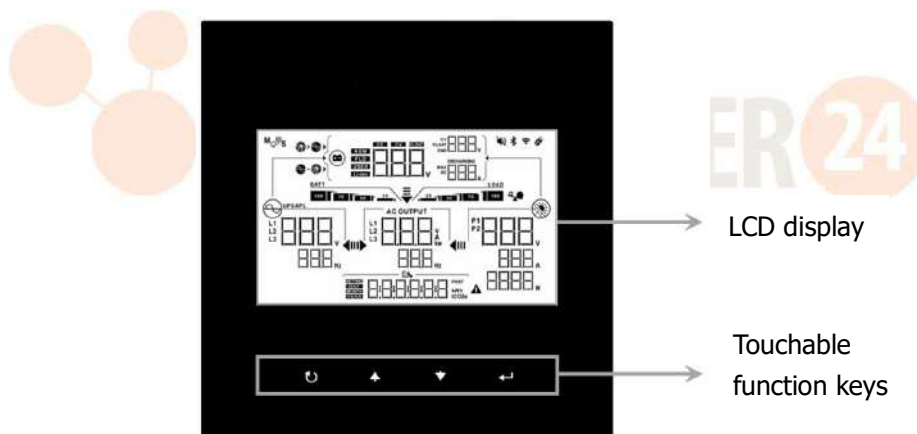

Touchable function key

Function keys		Description
↻	ESC	Exit the setting
	Access USB setting mode	To enter USB setting mode
▲	Up	To last selection
▼	Down	To next selection
↵	Enter	To confirm/enter the selection in setting mode

LCD Display Icons

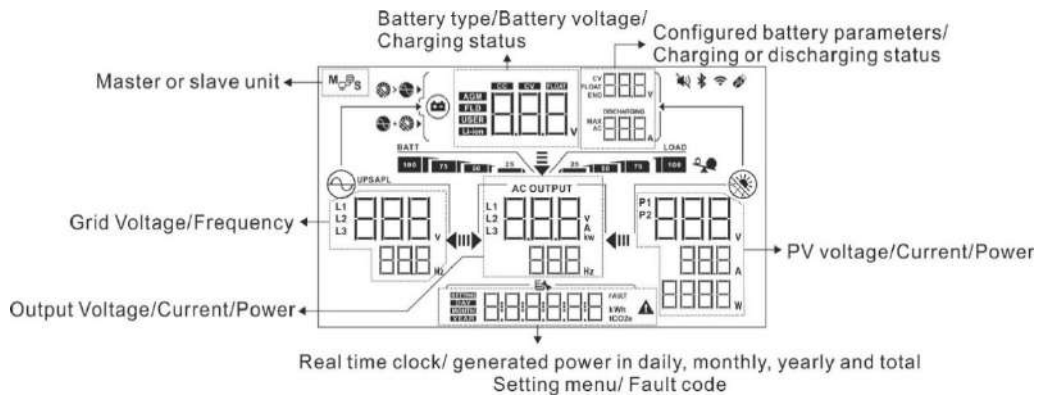

Icon	Function description		
Input Source Information			
	Indicates the AC input voltage and frequency.		
	Indicates the PV voltage, current and power.		
	Indicates the battery types, battery voltage, charging stage, configured battery parameters, charging or discharging current.		
Charging stage			
Icon	Charging stage	Icon	Charging stage
	CC mode		FLOATING mode
	CV mode		Full charged (Charger OFF)
Configuration Program and Fault Information			
	Indicates the setting programs.		
	Indicates the warning and fault codes. Warning: flashing with warning symbol. Fault: lighting with fault character.		
Output Information			
	Indicates the output voltage, load in VA, load in Watt and output frequency.		
Battery Information			
	Indicates battery level by 0-24%, 25-49%, 50-74% and 75-100% in battery mode and charging status in line mode.		
When battery is charging, it will present battery charging status.			
Status	Battery capacity	LCD Display	
C.C. mode	25%	4 bars will flash in turns.	
	50%	The right bar will be on and the other three bars will flash in	

C.V. mode		turns.
	75%	The right two bars will be on and the other two bars will flash in turns.
	100%	The right three bars will be on and the left bar will flash.
Floating mode. Batteries are fully charged.		4 bars will be on.

In battery mode, it will present battery capacity.

Icon	Battery capacity	Icon	Battery capacity
	25%		75%
	50%		100%

Load Information

	Indicates overload.
	Indicates the load level by 0-24%, 25-49%, 50-74% and 75-100%.

Charger Source Priority Setting Display

	Indicates setting program 16 "Charger source priority" is selected as "Solar first".
	Indicates setting program 16 "Charger source priority" is selected as "Solar and Utility".
	Indicates setting program 16 "Charger source priority" is selected as "Solar only".

Output source priority setting display

	Indicates setting program 01 "Output source priority" is selected as "Utility first".
	Indicates setting program 01 "Output source priority" is selected as "Solar first".
	Indicates setting program 01 "Output source priority" is selected as "SBU".

AC Input Voltage Range Setting Display

UPS	Indicates setting program 03 is selected as "UPS". The acceptable AC input voltage range will be within 170-280VAC
APL	Indicates setting program 03 is selected as "APL". The acceptable AC input voltage range will be within 90-280VAC

Operation Status Information

	Indicates unit connects to the mains.
	Indicates unit connects to the PV panel.

AGM FLD USER Li-ion	Indicates battery type.
M ₀ S	Indicates parallel operation is working.
	Indicates unit alarm is disabled.
	Indicates Wi-Fi transmission is working.
	Indicates USB disk is connected.

LCD Setting

General Setting



After pressing and holding “←” button for 3 seconds, the unit will enter the Setup Mode. Press “▲” or “▼” button to select setting programs. Press “←” button to confirm you selection or “/↻” button to exit.



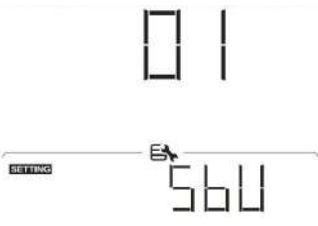
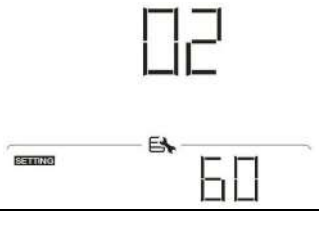

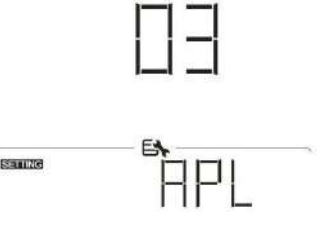
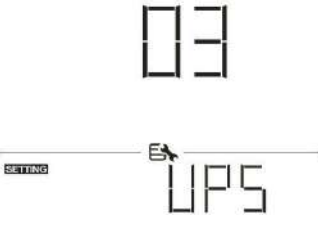
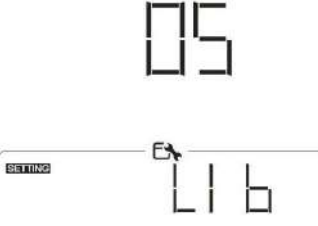
Setting Programs:

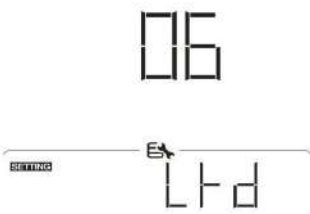
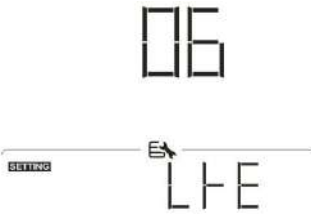
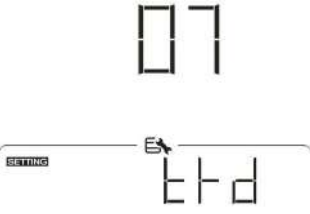
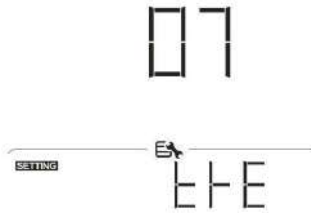
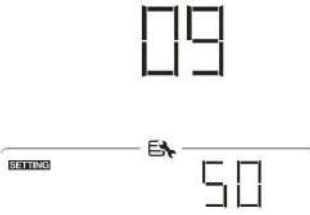
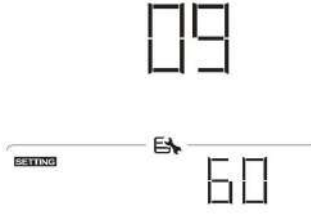
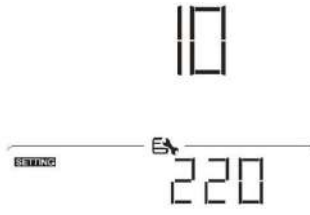
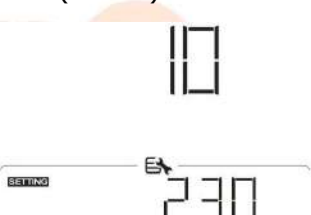
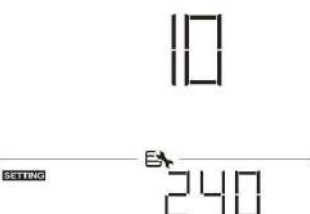
Program	Description	Selectable option	
00	Exit setting mode	Escape 	
01	Output source priority: To configure load power source priority	Utility first (default) 	Utility will provide power to the loads as first priority. Solar and battery energy will provide power to the loads only when utility power is not available.
		Solar first 	Solar energy provides power to the loads as first priority. If solar energy is not sufficient to power all connected loads, Utility energy will supply power to the loads at the same time.



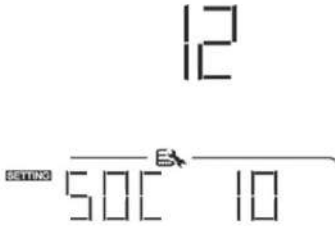
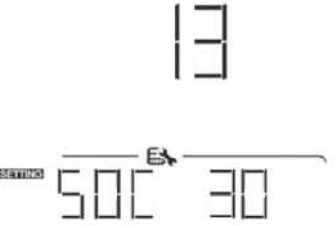

		<p>SBU priority</p> 	<p>Solar energy provides power to the loads as first priority. If solar energy is not sufficient to power all connected loads, battery energy will supply power to the loads at the same time. Utility provides power to the loads only when battery voltage drops to either low-level warning voltage or the setting point in program 12.</p>
02	<p>Maximum charging current: To configure total charging current for solar and utility chargers. (Max. charging current = utility charging current + solar charging current)</p>	<p>30A (default)</p> 	<p>Determined by battery pack and cannot be adjusted</p>

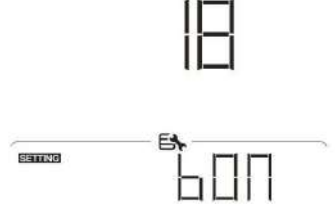
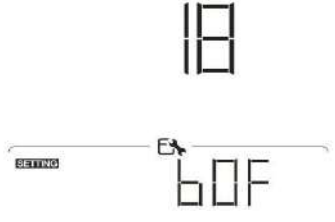

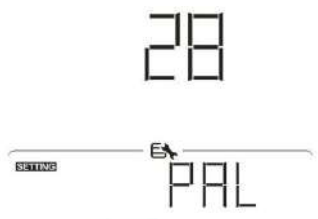
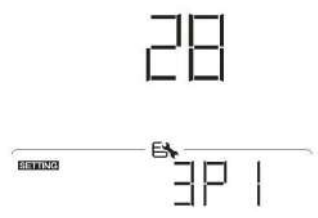

03	AC input voltage range	<p>Appliances (default)</p> 	<p>If selected, acceptable AC input voltage range will be within 90-280VAC</p>
		<p>UPS</p> 	<p>If selected, acceptable AC input voltage range will be within 170-280VAC</p>
05	Battery type	<p>LiB-protocol compatible battery</p> 	<p>This program cannot be revised.</p>

06	Auto restart when overload occurs	Restart disable (default) 	Restart enable 
07	Auto restart when over temperature occurs	Restart disable (default) 	Restart enable 
09	Output frequency	50Hz (default) 	60Hz 
10	Output voltage	220V 	230V (default) 
		240V 	
11	Maximum utility charging current Note: If setting value in program 02 is smaller than that in program in 11, the inverter will apply charging current from program 02 for utility charger.	30A (default) 	Setting range is from 2A, then 10A to 120A. Increment of each click is 10A.

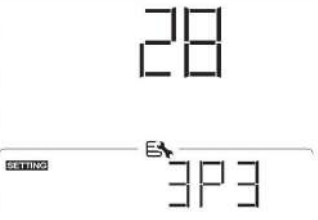
12	Setting SOC point back to utility source when selecting "SBU" (SBU priority) in program 01.	SOC 10% (default) 	Adjustable range is 5% to 95%. Increment of each click is 1%.
13	Setting SOC point back to battery mode when selecting "SBU" (SBU priority) in program 01.	SOC 30% (default) 	Setting range is 10% to 100%. Increment of each click is 1%.
16	Charger source priority: To configure charger source priority	If this inverter/charger is working in Line, Standby or Fault mode, charger source can be programmed as below: Solar first 	Solar energy will charge battery as first priority. Utility will charge battery only when solar energy is not available.
		Solar and Utility (default) 	Solar energy and utility will charge battery at the same time.
		Only Solar 	Solar energy will be the only charger source no matter utility is available or not.
18	Alarm control	Alarm on (default) 	Alarm off 

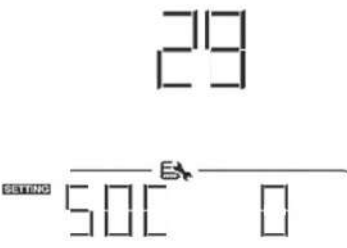
19	Auto return to default display screen	Return to default display screen (default)	If selected, no matter how users switch display screen, it will automatically return to default display screen after no button is pressed for 1 minute.
		Stay at latest screen	If selected, the display screen will stay at latest screen user finally switches.
20	Backlight control	Backlight on (default)	Backlight off
22	Beeps while primary source is interrupted	Alarm on (default)	Alarm off
23	Overload bypass: When enabled, the unit will transfer to line mode if overload occurs in battery mode.	Bypass disable (default)	Bypass enable
25	Record Fault code	Record enable (default)	Record disable

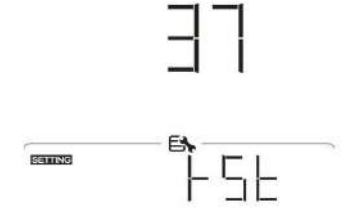
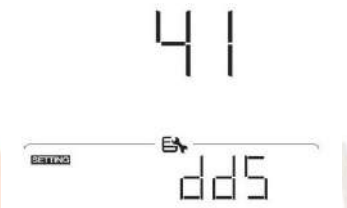
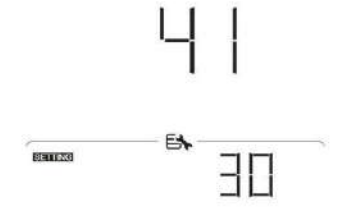
26	Bulk charging voltage (C.V voltage)	56V (default) 	Determined by battery pack and cannot be adjusted
27	Floating charging voltage	56V (default) 	Determined by battery pack and cannot be adjusted
28	AC output mode *This setting is only available when the inverter is in standby mode (Switch off).	Single: This inverter is used in single phase application. 	Parallel: This inverter is operated in parallel system. 
		When the inverter is operated in 3-phase application, set up inverter to be operated in specific phase.	
		L1 phase: 	L2 phase: 
		L3 phase: 	

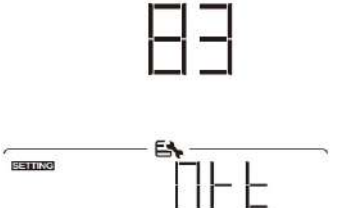
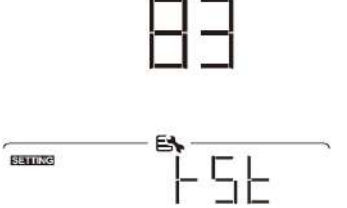





<p>29</p>	<p>Low DC cut-off capacity:</p> <ul style="list-style-type: none"> ● If battery power is only power source available, inverter will shut down. ● If PV energy and battery power are available, inverter will charge battery without AC output. <p>If PV energy, battery power and utility are all available, inverter will transfer to line mode</p>	<p>SOC 0% (default)</p> 	<p>Setting range is from 0% to 90%. Increment of each click is 1%.</p>
<p>37</p>	<p>Reset all stored data for PV generated power and output load energy</p>	<p>Not reset(Default)</p> 	<p>Reset</p> 
<p>41</p>	<p>Maximum battery discharging current</p>	<p>Disable (Default)</p> 	<p>If selected, battery discharge protection is disabled.</p>
		<p>30A</p>  <p>180A</p> 	<p>The setting range is from 30 A to 180 A. Increment of each click is 10A.</p> <p>If discharging current is higher than setting value, battery will stop discharging. At this time, if the utility is available, the inverter will operate in bypass mode. If no utility is available, the inverter will shut down output after 5-minute operation in battery mode.</p>
<p>83</p>	<p>Erase all data log</p>	<p>Not reset (Default)</p> 	<p>Reset</p> 

84	Data log recorded interval *The maximum data log number is 1200. If it's over 1200, it will re-write the first log.	3 minutes 	5 minutes
		10 minutes (default) 	20 minutes
		30 minutes 	60 minutes
85	Time setting – Minute		For minute setting, the range is from 0 to 59.
86	Time setting – Hour		For hour setting, the range is from 0 to 23.
87	Time setting– Day		For day setting, the range is from 1 to 31.



88	Time setting– Month		For month setting, the range is from 1 to 12.
89	Time setting – Year		For year setting, the range is from 17 to 99.
91	On/Off control for RGB LED *It's required to enable this setting to activate RGB LED lighting function.	<p>Enabled (default)</p>	<p>Disable</p>
92	Brightness of RGB LED	<p>Low</p>	<p>Normal (default)</p>
		<p>High</p>	
93	Lighting speed of RGB LED	<p>Low</p>	<p>Normal (default)</p>

		High 93 SETTING — E — HI	
--	--	--------------------------------	--

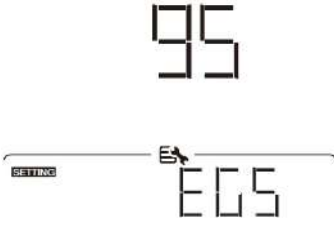

94	RGB LED effects	Power cycling 94 	Power wheel 94 
		Power chasing 94 	Solid on (Default) 94 
95	Data Presentation of data color *Energy source (Grid-PV-Battery) and battery charge/discharge status only available when RGB LED effects is set to Solid on.	Solar input power in watt 95 	LED lighting portion will be changed by the percentage of solar input power and nominal PV power. If "Solid on" is selected in #94, LED ring will light up with background color setting in #96. If "Power wheel" is selected in #94, LED ring will light up in 4 levels. If "cycling" or "chasing" is selected in #94, LED ring will light up in 12 levels.
		Battery capacity percentage (Default) 95 	LED lighting portion will be changed by battery capacity percentage. If "Solid on" is selected in #94, LED ring will light up with background color setting in #96. If "Power wheel" is selected in #94, LED ring will light up in 4 levels. If "cycling" or "chasing" is selected in #94, LED ring will light up in 12 levels.
		Load percentage. 95 	LED lighting portion will be changed by load percentage. If "Solid on" is selected in #94, LED ring will light up with background color setting in #96. If "Power wheel" is selected in #94, LED ring will light up in 4 levels. If "cycling" or "chasing" is selected in #94, LED ring will light up in 12 levels.

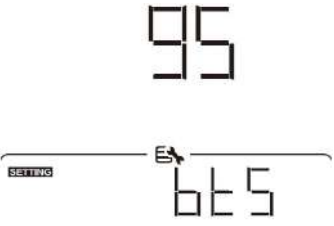
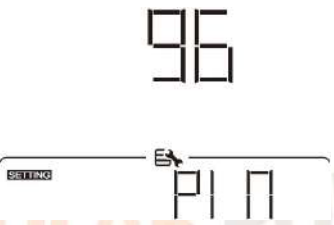
		Energy source(Grid-PV-Battery) 	If selected, the LED color will be background color setting in #96 in AC mode. If PV power is active, the LED color will be data color setting in #97. If the remaining status occur, the LED color will be set in #98.
--	--	--	---

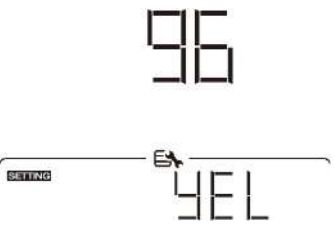
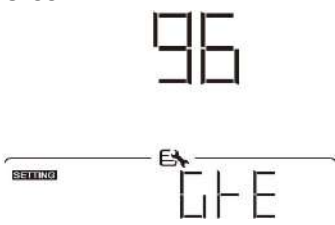
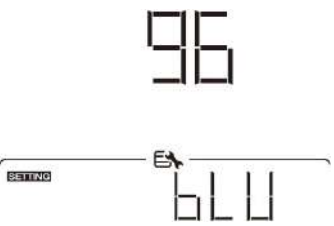
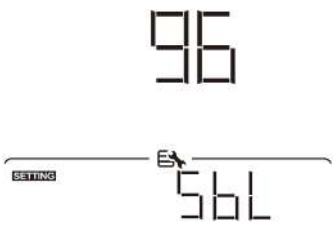
95	Data Presentation of data color *Energy source (Grid-PV-Battery) and battery charge/discharge status only available when RGB LED effects is set to Solid on.	Battery charge/discharge status 	If selected, the LED color will be background color setting in #96 in battery charging status. The LED color will be data color setting in #97 in battery discharging status.
96	Background color of RGB LED	Pink 	Orange 
		Yellow 	Green 
		Blue 	Sky blue (Default) 

		<p>Purple</p> <p>96</p> <p>SETTING ← E →</p> <p>PUR</p>	<p>Other: If selected, the background color is set by RGB via software.</p> <p>96</p> <p>SETTING ← E →</p> <p>0EH</p>
97	Data Color for RGB LED	<p>Pink</p> <p>97</p> <p>SETTING ← E →</p> <p>PIN</p>	<p>Orange</p> <p>97</p> <p>SETTING ← E →</p> <p>0FA</p>



97	Data Color for RGB LED	<p>Yellow</p> <p>97</p> <p>SETTING → 4EL</p>	<p>Green</p> <p>97</p> <p>SETTING → GFE</p>
		<p>Blue</p> <p>97</p> <p>SETTING → BLU</p>	<p>Sky blue</p> <p>97</p> <p>SETTING → SBL</p>
		<p>Purple (Default)</p> <p>97</p> <p>SETTING → PUT</p>	<p>Other: If selected, the data color is set by RGB via software.</p> <p>97</p> <p>SETTING → OEH</p>
		<p>Other: If selected, the data color is set by RGB via software.</p>	
98	<p>Background color of RGB LED</p> <p>*Only available when data Presentation of data color is set to Energy source (Grid-PV-Battery).</p>	<p>Pink</p> <p>98</p> <p>SETTING → PIN</p>	<p>Orange</p> <p>98</p> <p>SETTING → OPA</p>
		<p>Yellow</p> <p>98</p> <p>SETTING → YEL</p>	<p>Green</p> <p>98</p> <p>SETTING → GFE</p>
		<p>Blue</p> <p>98</p> <p>SETTING → BLU</p>	<p>Sky blue (Default)</p> <p>98</p> <p>SETTING → SBL</p>
		<p>Other: If selected, the data color is set by RGB via software.</p>	

		<p>Purple</p>	<p>Other: If selected, the background color is set by RGB via software.</p>
99	<p>Timer Setting for Output Source Priority</p>	<p>Once access this program, it will show "OPP" in LCD. Press "←" button to select timer setting for output source priority. There are three timers to set up. Press "▲" or "▼" button to select specific timer option. Then, press "←" to confirm timer option. Press "▲" or "▼" button to adjust starting time first and the setting range is from 00 to 23. Increment of each click is one hour. Press "←" to confirm starting time setting. Next, the cursor will jump to right column to set up end time. Once end time is set completely, press "←" to confirm all setting.</p> <p>Utility first timer</p>	<p>Solar first timer</p>
		<p>SBU priority timer</p>	
100	<p>Timer Setting for Charger Source Priority</p>	<p>Once access this program, it will show "CGP" in LCD. Press "←" button to select timer setting for charger source priority. There are three timers to set up. Press "▲" or "▼" button to select specific timer option. Then, press "←" to confirm timer option. Press "▲" or "▼" button to adjust starting time first and the setting range is from 00 to 23. Increment of each click is one hour. Press "←" to confirm starting time setting. Next, the cursor will jump to right column to set up end time. Once end time is set completely, press "←" to confirm all setting.</p>	

		Solar first 	Solar and utility
		Only solar 	

USB Function Setting

There are three USB function setting such as firmware upgrade, data log export and internal parameter re-write from the USB disk. Please follow below procedure to execute selected USB function setting.

Procedure	LCD Screen
Step 1: Insert an OTG USB disk into the USB port (L).	
Step 2: Press "↻" button to enter USB function setting.	

Step 3: Please select setting program by following the procedure.

Program#	Operation Procedure	LCD Screen
Upgrade firmware	After entering USB function setting, press "←" button to enter "upgrade firmware" function. This function is to upgrade inverter firmware. If firmware upgrade is needed, please check with your dealer or installer for detail instructions.	
Re-write internal parameters	After entering USB function setting, press "▼" button to switch to "Re-write internal parameters" function. This function is to over-write all parameter settings (TEXT file) with settings in the USB disk from a previous setup or to duplicate inverter settings. Please check with your dealer or installer for detail instructions.	
Export data log	After entering USB function setting, press "▼" button twice to switch to "export data log" function and it will show "LOG" in the LCD. Press "←" button to confirm the selection for export data log. If the selected function is ready, LCD will display "t d y". Press "←" button to confirm the selection again.	

	<ul style="list-style-type: none"> ● Press "▲" button to select "Yes" to export data log. "YES" will disappear after this action is complete. Then, press "↻" button to return to main screen. ● Or press "▼" button to select "No" to return to main screen. 	

If no button is pressed for 1 minute, it will automatically return to main screen.

Error message:

Error Code	Messages
U01	No USB disk is detected.
U02	USB disk is protected from copy.
U03	Document inside the USB disk with wrong format.

If any error occurs, error code will only show 3 seconds. After 3 seconds, it will automatically return to display screen.

LCD Display

The LCD display information will be switched in turn by pressing the "▲" or "▼" button. The selectable information is switched as the following table in order.

Selectable information	LCD display
Default Display Screen	<p>Input Voltage=230V, Input frequency=50Hz</p> <p>AGM 50.4 V CV 56.4 V CHARGING MAX AC 20 A LOAD</p> <p>BATT UPS 230 V 500 Hz AC OUTPUT 230 V 500 Hz P1</p> <p>DATE 20.12.14</p> <p>V A W</p>
PV voltage/ PV current/ PV power	PV1 voltage=300V, PV1 current=2.0A, PV1 power=600W

(PV1 and PV2 switch every 5 seconds)







PV2 voltage=300V, PV2 current=2.0A, PV2 power=600W



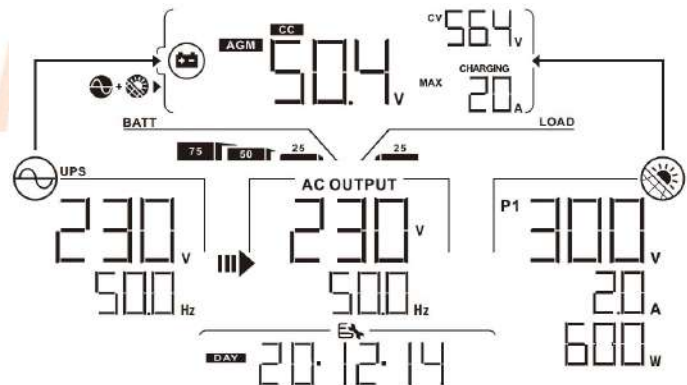



Battery voltage, charging stage/
Configured battery parameters/
Charging or discharging current

Battery voltage=50.4V, Bulk charging voltage=56.4V,
Charging current=20A

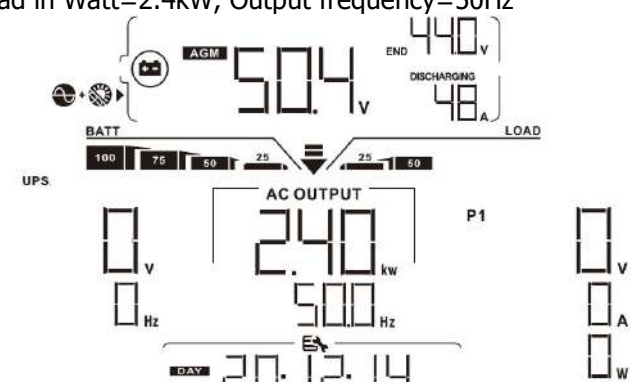

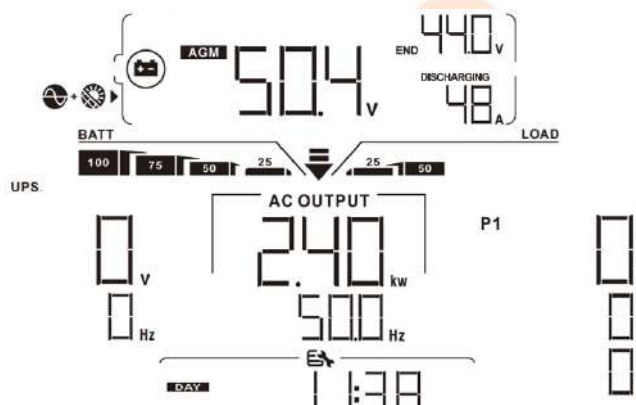
<p>Default Display Screen</p>	<p>Battery voltage, charging stage/ Configured battery parameters/ Charging or discharging current</p>	<p>Battery voltage=53.9V, Floating charging voltage=54.0V, Charging current=1A</p> 
	<p>Battery voltage=50.4V, Low DC cut-off voltage=44.0V, Discharging current=48A</p> 	<p>Output voltage=230V, Output frequency=50Hz</p> 
	<p>Output voltage, load in VA, load in Watt switch every 5 second/ Output frequency</p>	<p>Load in VA=2.4kVA, Output frequency=50Hz</p> 

<p>Default Display Screen</p>	<p>Output voltage, load in VA, load in Watt switch every 5 second/ Output frequency</p>	<p>Load in Watt=2.4kW, Output frequency=50Hz</p> 
<p>Real date</p>	<p>Real date.</p>	<p>Real date Dec 14, 2020.</p> 
<p>Real time.</p>	<p>Real time.</p>	<p>Real time 11:38.</p> 
<p>PV energy generation today</p>	<p>PV energy generation today</p>	<p>PV energy generation today =888Wh.</p> 

<p>PV energy generation this month</p>	<p>PV energy generation this month =8.88kWh.</p>
<p>PV energy generation this year</p>	<p>PV energy generation this year =88.8kWh.</p>
<p>Total PV energy generation</p>	<p>Total PV energy generation =888kWh.</p>
<p>Load output energy today</p>	<p>Load output energy today =888Wh.</p>

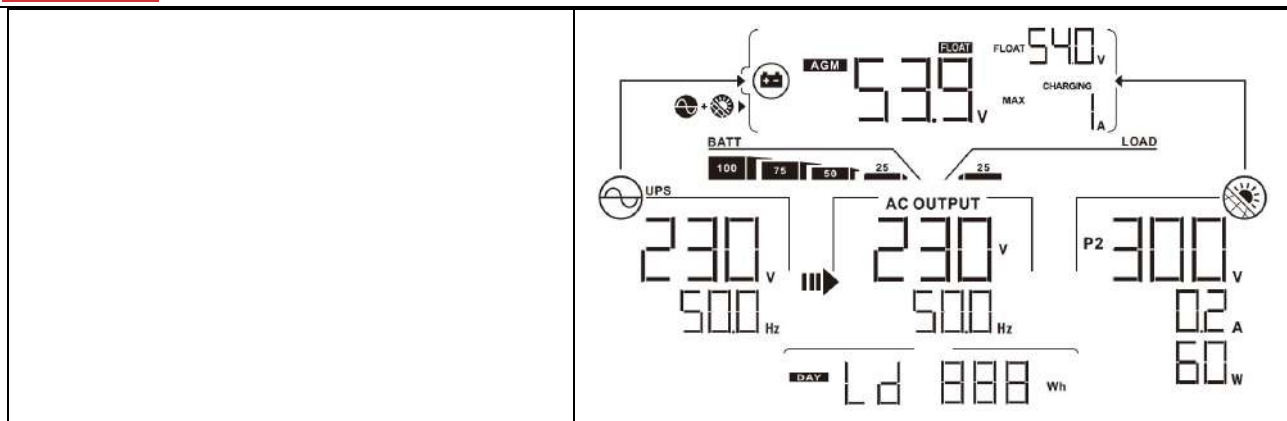

<p>Load output energy this month</p>	<p>Load output energy this month =8.88kWh.</p>
<p>Load output energy this year</p>	<p>Load output energy this year =88.8kWh.</p>
<p>Total load output energy</p>	<p>Total load output energy =888kWh.</p>
<p>Main CPU version checking.</p>	<p>Main CPU version 00050.72.</p>

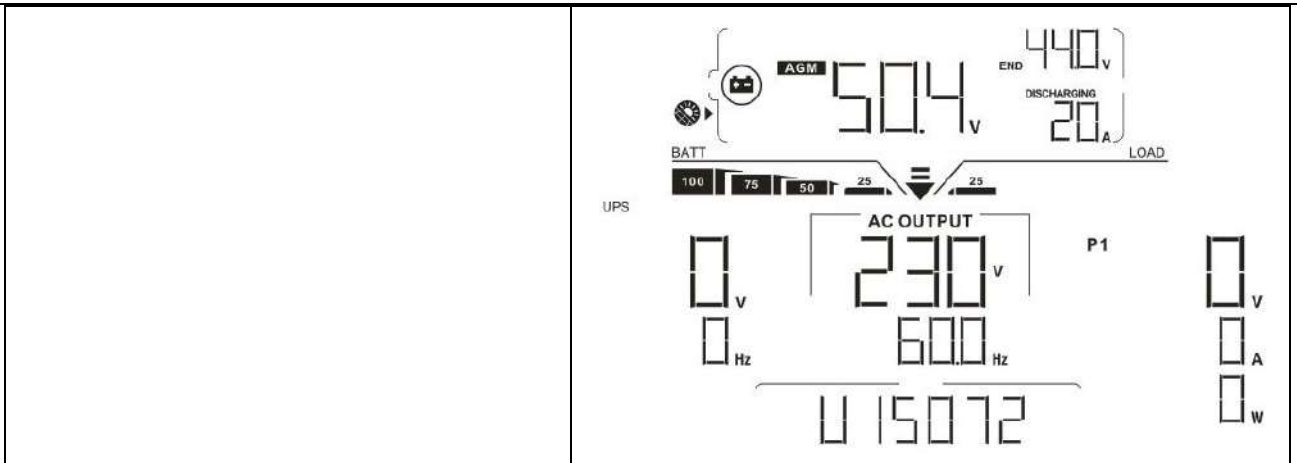

<p>Secondary CPU version checking.</p>	<p>Secondary CPU version 00022.01.</p>  <p>The display shows a battery level bar at 100%, a battery icon with 'AGM' and '50.4 V', a '44.0 V' end voltage, 'DISCHARGING 20 A', and 'LOAD'. The AC output section shows '230 V', '600 Hz', and 'P1'. The version number '022201' is displayed at the bottom.</p>
<p>Wi-Fi version checking</p>	<p>Wi-Fi version 00088.88.</p>  <p>The display shows a battery level bar at 100%, a battery icon with 'AGM' and '50.4 V', a '44.0 V' end voltage, 'DISCHARGING 20 A', and 'LOAD'. The AC output section shows '230 V', '600 Hz', and 'P1'. The version number '038888' is displayed at the bottom.</p>

Operating Mode Description

Operation mode	Description	LCD display
<p>Standby mode</p> <p>Note:</p> <p>*Standby mode: The inverter is not turned on yet but at this time, the inverter can charge battery without AC output.</p>	<p>No output is supplied by the unit but it still can charge batteries.</p>	<p>Charging by utility and PV energy.</p>
		<p>Charging by utility.</p>
		<p>Charging by PV energy.</p>
		<p>No charging.</p>

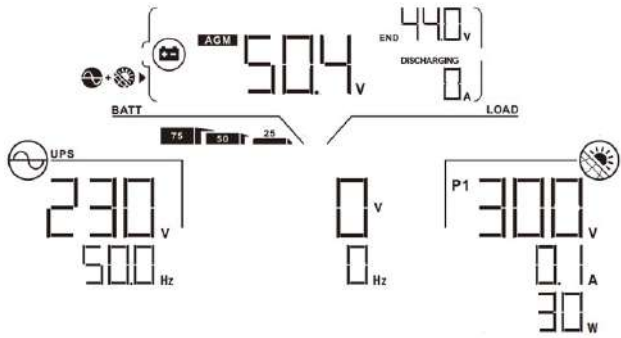
<p>Fault mode</p> <p>Note:</p> <p>*Fault mode: Errors are caused by inside circuit error or external reasons such as over temperature, output short circuited and so on.</p>	<p>No charging at all no matter if grid or PV power is available.</p>	<p>Grid and PV power are available.</p> 
--	---	--

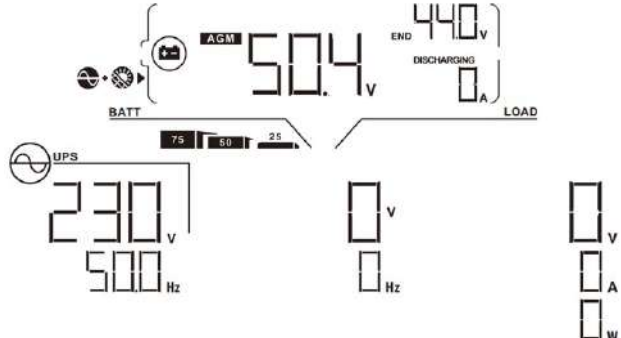
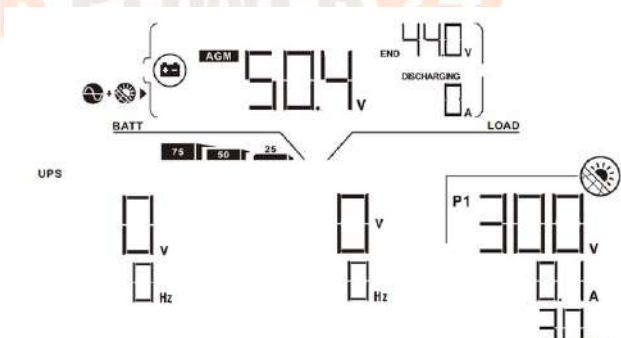
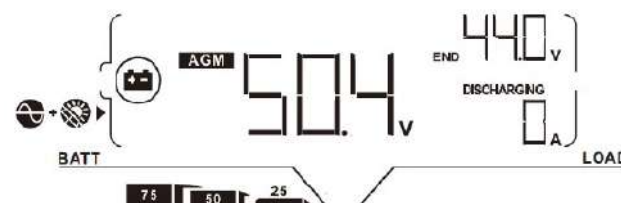
Operation mode	Description	LCD display
<p>Fault mode</p> <p>Note:</p> <p>*Fault mode: Errors are caused by inside circuit error or external reasons such as over temperature, output short circuited and so on.</p>	<p>No charging at all no matter if grid or PV power is available.</p>	<p>Grid is available.</p> 
		<p>PV power is available.</p> 
		<p>No charging.</p> 
<p>Line Mode</p>	<p>The unit will provide</p>	<p>Charging by utility and PV energy.</p>

	<p>output power from the mains. It will also charge the battery at line mode.</p>	<p>Charging by utility.</p>
--	---	-----------------------------

Operation mode	Description	LCD display
Line Mode	<p>The unit will provide output power from the mains. It will also charge the battery at line mode.</p>	<p>If "SUB" (solar first) is selected as output source priority and solar energy is not sufficient to provide the load, solar energy and the utility will provide the loads and charge the battery at the same time.</p> <p>If either "SUB" (solar first) or "SBU" is selected as output source priority and battery is not connected, solar energy and the utility will provide the loads.</p>

		<p>Power from utility</p>
<p>Battery Mode</p>	<p>The unit will provide output power from battery and/or PV power.</p>	<p>Power from battery and PV energy.</p>













Operation mode	Description	LCD display
<p>Battery Mode</p>	<p>The unit will provide output power from battery and/or PV power.</p>	<p>PV energy will supply power to the loads and charge battery at the same time. No utility is available.</p>
		<p>Power from battery only.</p>
		<p>Power from PV energy only.</p>

Faults Reference Code

Fault Code	Fault Event	Icon on
01	Fan is locked when inverter is off.	F01
02	Over temperature	F02
03	Battery voltage is too high	F03
04	Battery voltage is too low	F04
05	Output short circuited.	F05
06	Output voltage is too high.	F06
07	Overload time out	F07
08	Bus voltage is too high	F08
09	Bus soft start failed	F09
10	PV over current	F10
11	PV over voltage	F11
12	DCDC over current	F12
13	Battery discharge over current	F13
51	Over current	F51
52	Bus voltage is too low	F52
53	Inverter soft start failed	F53
55	Over DC voltage in AC output	F55
57	Current sensor failed	F57
58	Output voltage is too low	F58

Warning Indicator

Warning Code	Warning Event	Audible Alarm	Icon flashing
01	Fan is locked when inverter is on.	Beep three times every second	01 
02	Over temperature	None	02 
03	Battery is over-charged	Beep once every second	03 
04	Low battery	Beep once every second	04 
07	Overload	Beep once every 0.5 second	07  
10	Output power derating	Beep twice every 3 seconds	10 
15	PV energy is low.	Beep twice every 3 seconds	15 
16	High AC input (>280VAC) during BUS soft start	None	16 
32	Communication failure between inverter and display panel	None	32 
E9	Battery equalization	None	E9 

CLEARANCE AND MAINTENANCE FOR ANTI-DUST KIT

Overview

Every inverter is already installed with anti-dusk kit from factory. This kit keeps dusk from your inverter and increases product reliability in harsh environment.

Clearance and Maintenance

Step 1: Please remove the side cover of the inverter.

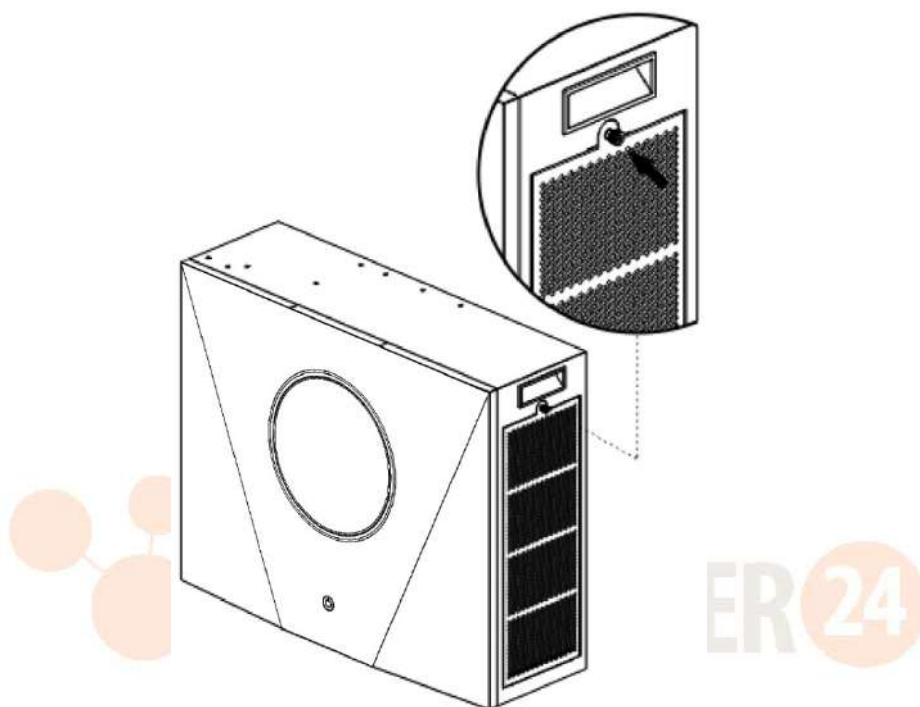

Step 2: Then, dustproof case can be removed and take out air filter foam as shown in below chart.

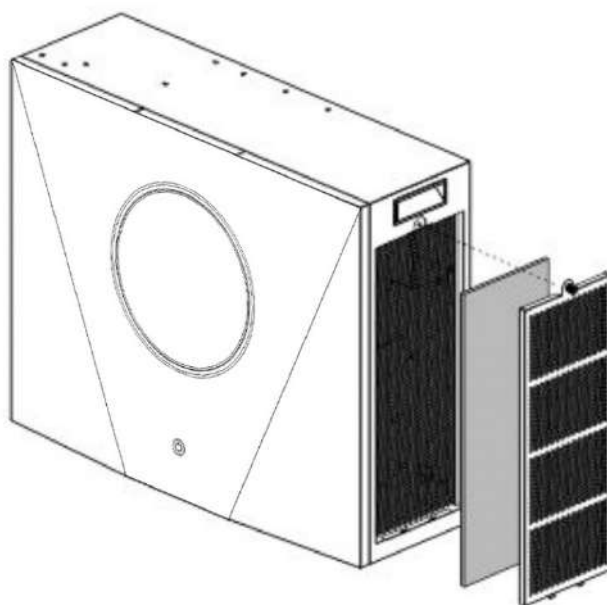

Step 3: Clean air filter foam and dustproof case. After clearance, re-assemble the dust-kit back to the inverter.

NOTICE: The anti-dust kit should be cleaned from dust every one month.

SPECIFICATIONS

Table 1 Line Mode Specifications

Inverter Power Rating	8KW
Input Voltage Waveform	Sinusoidal (utility or generator)
Nominal Input Voltage	230Vac
Low Loss Voltage	170Vac±7V (UPS) 90Vac±7V (Appliances)
Low Loss Return Voltage	180Vac±7V (UPS); 100Vac±7V (Appliances)
High Loss Voltage	280Vac±7V
High Loss Return Voltage	270Vac±7V
Max AC Input Voltage	300Vac
Max AC Input Current	60A
Nominal Input Frequency	50Hz / 60Hz (Auto detection)
Low Loss Frequency	40±1Hz
Low Loss Return Frequency	42±1Hz
High Loss Frequency	65±1Hz
High Loss Return Frequency	63±1Hz
Output Short Circuit Protection	Line mode: Circuit Breaker Battery mode: Electronic Circuits
Efficiency (Line Mode)	>95% (Rated R load, battery full charged)
Transfer Time	10ms typical (UPS); 20ms typical (Appliances)
Output power de-rating: When AC input voltage under 170V the output power will be de-rated.	 <p>8K model</p>

Table 2 Inverter Mode Specifications

Utility Inverter Mode	
Rated Output Power	8000W
Output Voltage Waveform	Pure Sine Wave
Output Voltage Regulation	230Vac±5%
Output Frequency	60Hz or 50Hz
Peak Efficiency	93%
Overload Protection	100ms@≥205% load;5s@≥150% load; 10s@110%~150% load
Surge Capacity	2* rated power for 5 seconds
Low DC Warning capacity	Setting of Program 29 + 10%
Low DC Cut-off level	Setting of Program 29
High DC Recovery Voltage	52.5Vdc (ESS LIO-I-4810), 56Vdc (ESS LIO-II-4810)
High DC Cut-off Voltage	54Vdc (ESS LIO-I-4810); 57.5Vdc (ESS LIO-II-4810)
DC Voltage Accuracy	+/-0.3V@ no load
THDV	<5% for linear load,<10% for non-linear load @ nominal voltage
DC Offset	≅ 100mV
No Load Power Consumption	<75W

Table 3 Charge Mode Specifications

Utility Charging Mode	
Charging Current (UPS) @ Nominal Input Voltage	30A (@ $V_{I/P}=230V_{ac}$)
Bulk Charging Voltage	52.5Vdc (ESS LIO-I-4810); 56.0Vdc (ESS LIO-II-4810)
Floating Charging Voltage	52.5Vdc (ESS LIO-I-4810); 56.0Vdc (ESS LIO-II-4810)
Overcharge Protection	54.0Vdc (ESS LIO-I-4810); 57.5Vdc (ESS LIO-II-4810)
Charging Algorithm	3-Step
Charging Curve	
Solar Input	
Rated Power	8000W
Max. PV Array Open Circuit Voltage	500Vdc
PV Array MPPT Voltage Range	90Vdc~450Vdc
Max. Input Current	18A x 2
Start-up Voltage	80V +/- 5Vdc
Power Limitation	

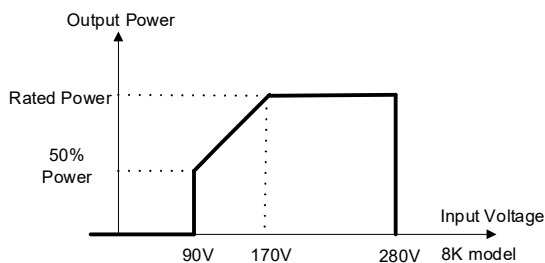

Table 4 General Specifications

Safety Compliance	CE
Operating Temperature Range	-10°C to 50°C
Storage temperature	-15°C~ 60°C
Humidity	5% to 95% Relative Humidity (Non-condensing)
Dimension (D*W*H), mm	214 x 621 x 500
Net Weight, kg	25

Table 5 Parallel Specifications

Max parallel numbers	3
Circulation Current under No Load Condition	Max 2A
Power Unbalance Ratio	<5% @ 100% Load
Parallel communication	CAN
Transfer time in parallel mode	Max 50ms
Parallel Kit	YES

Note: Parallel feature will be disabled when only PV power is available.

Table 6 Battery Module Specifications

Nominal Voltage	48VDC
Typical Capacity	100 Ah
Max Discharging Current	150A
Protection	BMS, breaker
Dimension, D X W X H (mm)	214 x 621 x 550
Net Weight (kgs)	55

TROUBLE SHOOTING

Problem	LCD/LED/Buzzer	Explanation / Possible cause	What to do
Unit shuts down automatically during startup process.	LCD/LEDs and buzzer will be active for 3 seconds and then complete off.	The battery voltage is too low (<1.91V/Cell)	1. Re-charge battery. 2. Replace battery.
No response after power on.	No indication.	1. The battery voltage is far too low. (<1.4V/Cell) 2. Battery polarity is connected reversed.	1. Check if batteries and the wiring are connected well. 2. Re-charge battery. 3. Replace battery.
Mains exist but the unit works in battery mode.	Input voltage is displayed as 0 on the LCD and green LED is flashing.	Input protector is tripped	Check if AC breaker is tripped and AC wiring is connected well.
	Green LED is flashing.	Insufficient quality of AC power. (Shore or Generator)	1. Check if AC wires are too thin and/or too long. 2. Check if generator (if applied) is working well or if input voltage range setting is correct. (UPS→Appliance)
	Green LED is flashing.	Set "Solar First" as the priority of output source.	Change output source priority to Utility first.
When the unit is turned on, internal relay is switched on and off repeatedly.	LCD display and LEDs are flashing	Battery is disconnected.	Check if battery wires are connected well.
Buzzer beeps continuously and red LED is on.	Fault code 07	Overload error. The inverter is overload 110% and time is up.	Reduce the connected load by switching off some equipment.
	Fault code 05	Output short circuited.	Check if wiring is connected well and remove abnormal load.
		Temperature of internal converter component is over 120°C. (Only available for 1-3KVA models.)	Check whether the air flow of the unit is blocked or whether the ambient temperature is too high.
	Fault code 02	Internal temperature of inverter component is over 100°C.	
	Fault code 03	Battery is over-charged.	Return to repair center.
		The battery voltage is too high.	Check if spec and quantity of batteries are meet requirements.
	Fault code 01	Fan fault	Replace the fan.
	Fault code 06/58	Output abnormal (Inverter voltage below than 190Vac or is higher than 260Vac)	1. Reduce the connected load. 2. Return to repair center
	Fault code 08/09/53/57	Internal components failed.	Return to repair center.
	Fault code 51	Over current or surge.	Restart the unit, if the error happens again, please return to repair center.
Fault code 52	Bus voltage is too low.		
Fault code 55	Output voltage is unbalanced.		

Appendix I: Parallel function

1. Introduction

This inverter can be used in parallel with two different operation modes.

1. Parallel operation in single phase is with up to 3 units. The supported maximum output power is 24KW/24KVA.
2. Three units work together (each unit on one phase) to support three-phase equipment.

2. Mounting the Unit

When installing multiple units, please follow below chart.

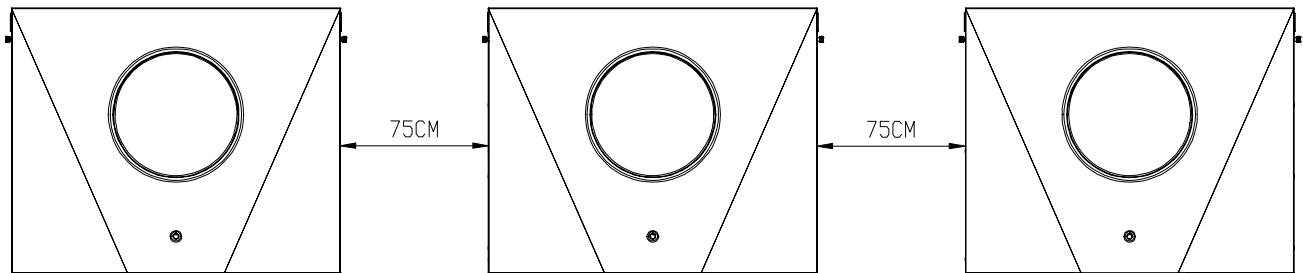

NOTE: For proper air circulation to dissipate heat, allow a clearance of approx. 75 cm to the side.

3. Wiring Connection

WARNING: It's REQUIRED to connect battery for parallel operation.

The cable size of each inverter is shown as below:

Recommended battery cable and terminal size for each inverter:

Wire Size	Cable mm ²	Ring Terminal Dimensions		Torque value
		D (mm)	L (mm)	
		1*2/0AWG	67.4	

Ring terminal:

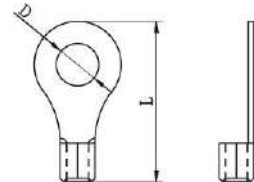

WARNING: Be sure the length of all battery cables is the same. Otherwise, there will be voltage difference between inverter and battery to cause parallel inverters not working.

Recommended AC input and output cable size for each inverter:

AWG no.	Torque
8 AWG	1.4~ 1.6 Nm

You need to connect the cables of each inverter together. Take the battery cables for example: You need to use a connector or bus-bar as a joint to connect the battery cables together, and then connect to the battery terminal. The cable size used from joint to battery should be X times cable size in the tables above. "X" indicates the number of inverters connected in parallel.

Regarding AC input and output, please also follow the same principle.

CAUTION!! Please install the breaker at the battery and AC input side. This will ensure the inverter can be securely disconnected during maintenance and fully protected from over current of battery or AC input.

Recommended breaker specification of battery for each inverter:

1 unit*
250A/70VDC

*If you want to use only one breaker at the battery side for the whole system, the rating of the breaker should be X times current of 1 unit. "X" indicates the number of inverters connected in parallel.



Recommended breaker specification of AC input with single phase:

2 units	3 units
120A/230VAC	180A/230VAC

Note 1: Also, you can use 60A breaker with only 1 unit and install one breaker at its AC input in each inverter.

Note 2: Regarding three-phase system, you can use 4-pole breaker directly and the rating of the breaker should be compatible with the phase current limitation from the phase with maximum units.

Recommended battery capacity

Inverter parallel numbers	2	3
Battery Capacity	200AH	400AH

WARNING! Be sure that all inverters will share the same battery bank. Otherwise, the inverters will transfer to fault mode.

4-1. Parallel Operation in Single phase

Two inverters in parallel:

Power Connection

Communication Connection



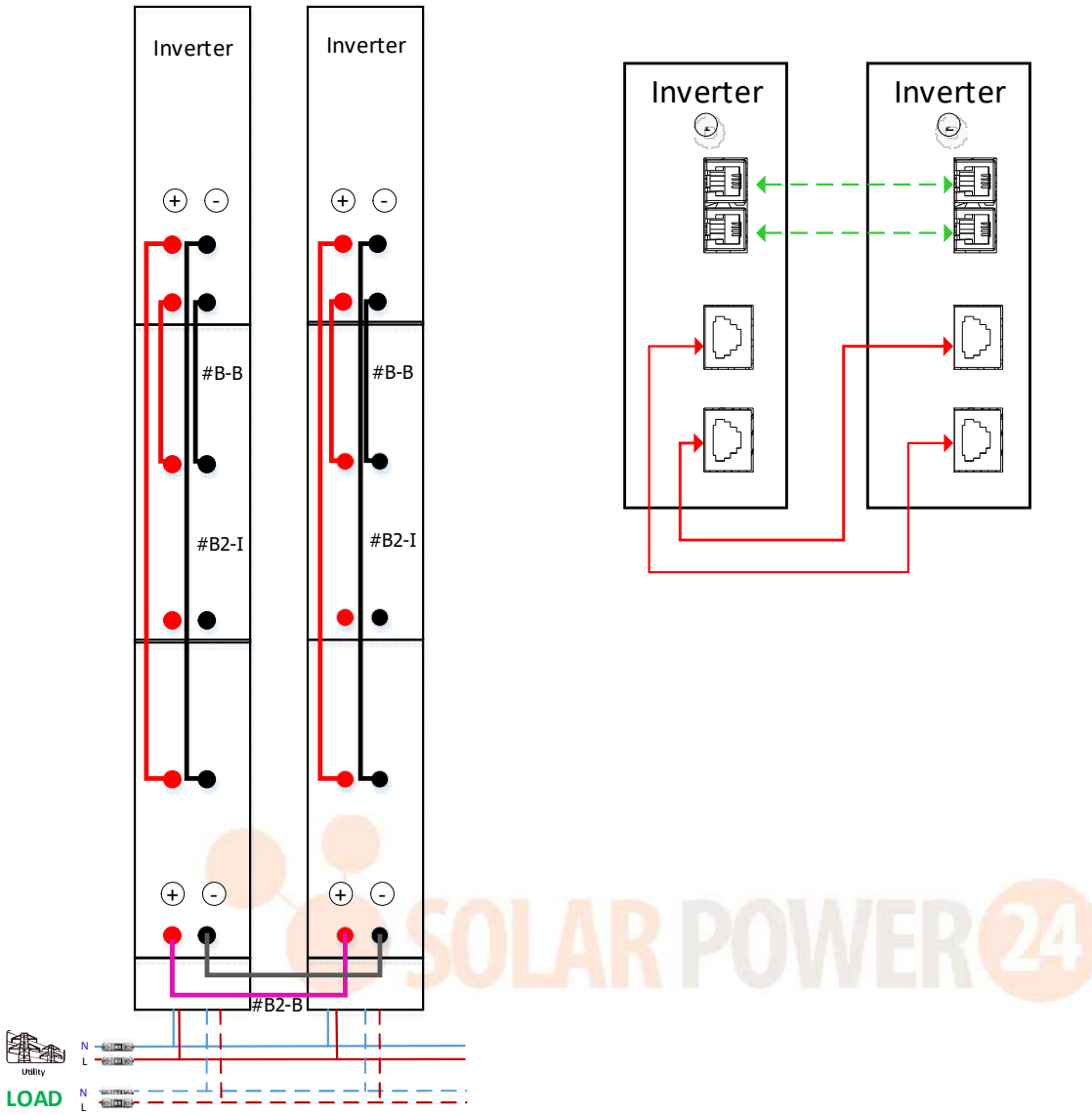

Three inverters in parallel:

Power Connection

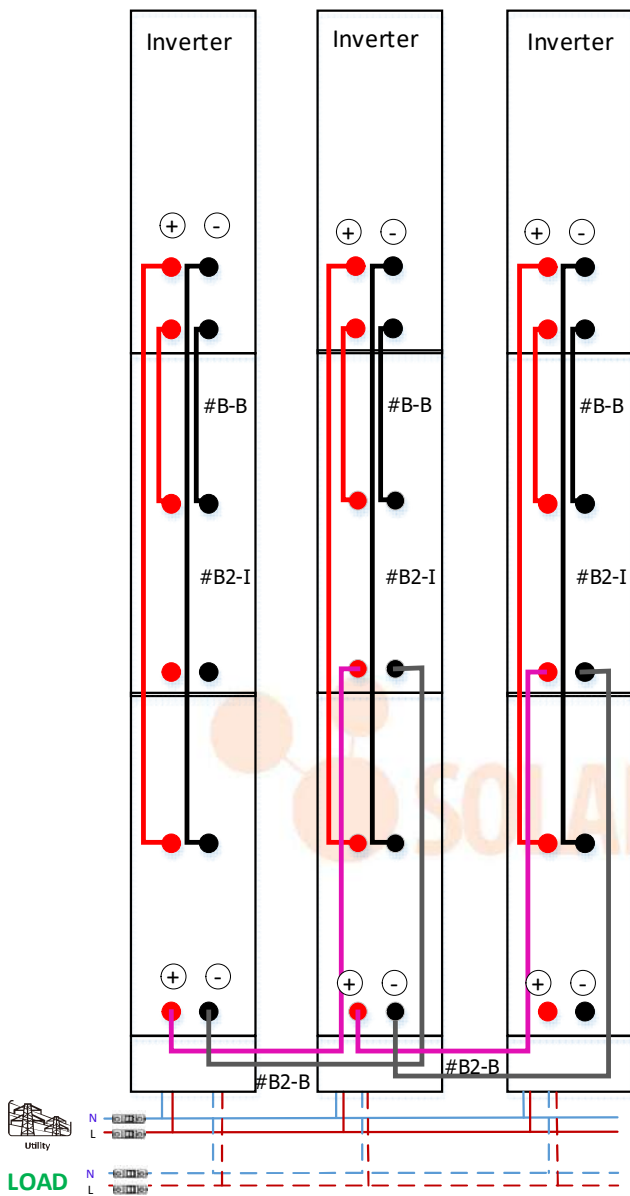

Communication Connection

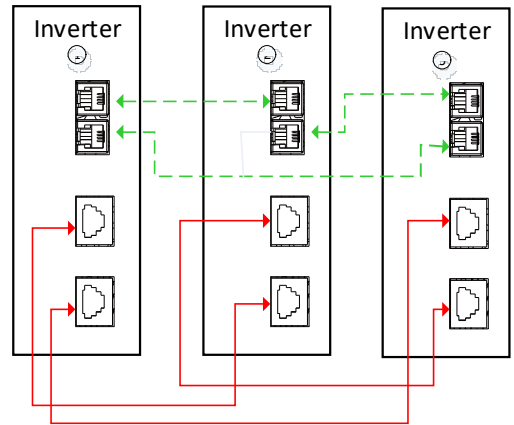

6. LCD Setting and Display

Setting Program:

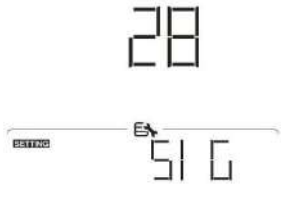
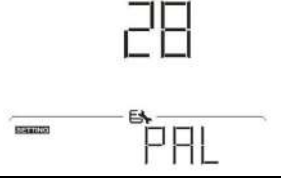
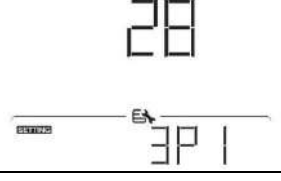
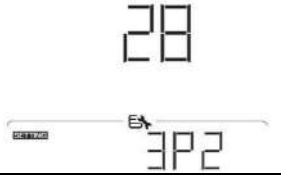
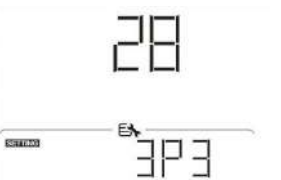
Program	Description	Selectable option	
28	AC output mode *This setting is able to set up only when the inverter is in standby mode. Be sure that on/off switch is in "OFF" status.	Single	<p>When the unit is operated alone, please select "SIG" in program 28.</p> <p>When the units are used in parallel for single phase application, please select "PAL" in program 28. Please refer to 5-1 for detailed information.</p> <p>When the units are operated in 3-phase application, please choose "3PX" to define each inverter. It's required to have at least one inverter in each phase for three-phase application. Please refers to 5-2 for detailed information.</p> <p>Please select "3P1" in program 28 for the inverter connected to L1 phase, "3P2" in program 28 for the inverter connected to L2 phase and "3P3" in program 28 for the inverter connected to L3 phase.</p> <p>Be sure to connect share current cable to units which are on the same phase. Do NOT connect share current cable between units on different phases.</p>
			
		Parallel	
			
		L1 phase:	
			
L2 phase:			
L3 phase:			

Fault code display:

Fault Code	Fault Event	Icon on
60	Power feedback protection	F60
71	Firmware version inconsistent	F71
72	Current sharing fault	F72
80	CAN fault	F80
81	Host loss	F81
82	Synchronization loss	F82
83	Battery voltage detected different	F83
84	AC input voltage and frequency detected different	F84
85	AC output current unbalance	F85
86	AC output mode setting is different	F86

Code Reference:

Code	Description	Icon on
NE	Unidentified unit master or slave	NE 24
HS	Master unit	HS
SL	Slave unit	SL

7. Commissioning

Parallel in single phase

Step 1: Check the following requirements before commissioning:

- Correct wire connection
- Ensure all breakers in Line wires of load side are open and each Neutral wires of each unit are connected together.

Step 2: Turn on each unit and set "PAL" in LCD setting program 28 of each unit. And then shut down all units.

NOET: It's necessary to turn off switch when setting LCD program. Otherwise, the setting cannot be programmed.

Step 3: Turn on each unit.

LCD display in Master unit	LCD display in Slave unit
----------------------------	---------------------------

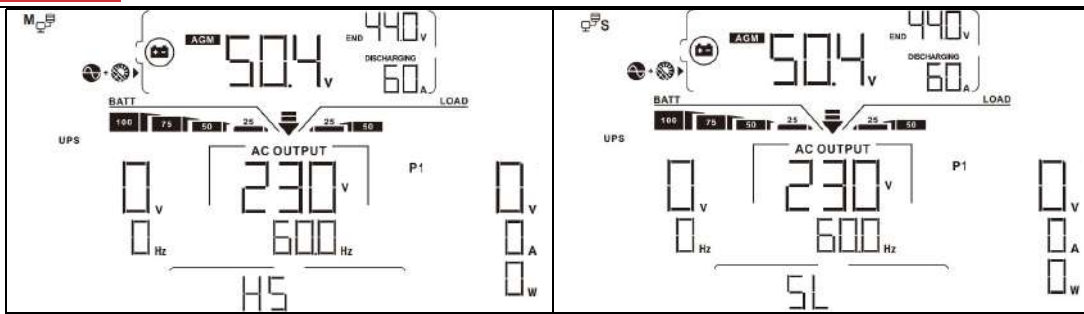

NOTE: Master and slave units are randomly defined.

Step 4: Switch on all AC breakers of Line wires in AC input. It's better to have all inverters connect to utility at the same time. If not, it will display fault 82 in following-order inverters. However, these inverters will automatically restart. If detecting AC connection, they will work normally.

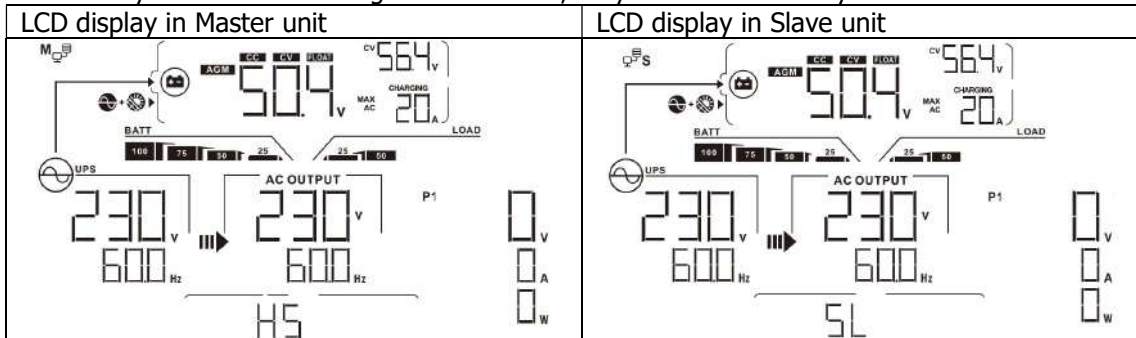

Step 5: If there is no more fault alarm, the parallel system is completely installed.

Step 6: Please switch on all breakers of Line wires in load side. This system will start to provide power to the load.

Support three-phase equipment

Step 1: Check the following requirements before commissioning:

- Correct wire connection
- Ensure all breakers in Line wires of load side are open and each Neutral wires of each unit are connected together.

Step 2: Turn on all units and configure LCD program 28 as P1, P2 and P3 sequentially. And then shut down all units.

NOET: It's necessary to turn off switch when setting LCD program. Otherwise, the setting cannot be programmed.

Step 3: Turn on all units sequentially.

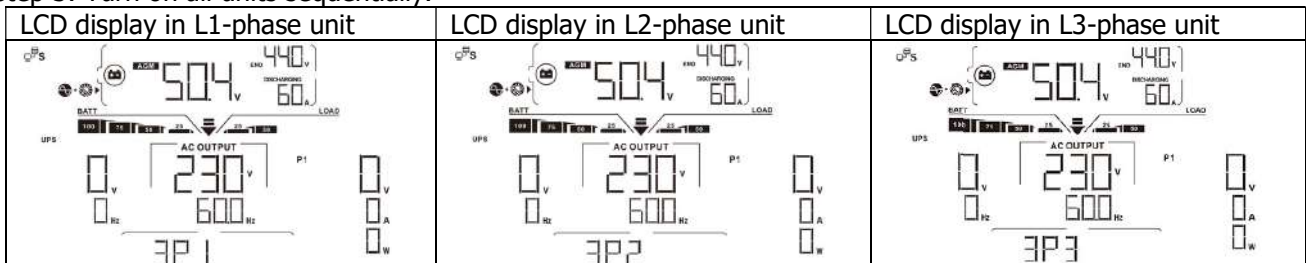

Step 4: Switch on all AC breakers of Line wires in AC input. If AC connection is detected and three phases are matched with unit setting, they will work normally. Otherwise, the AC icon will flash and they will not work in line mode.

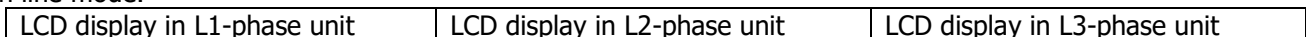



Step 5: If there is no more fault alarm, the system to support 3-phase equipment is completely installed.

Step 6: Please switch on all breakers of Line wires in load side. This system will start to provide power to the load.

Note 1: To avoid overload occurring, before turning on breakers in load side, it's better to have whole system in operation first.

Note 2: Transfer time for this operation exists. Power interruption may happen to critical devices, which cannot bear transfer time.



8. Trouble shooting

Situation		Solution
Fault Code	Fault Event Description	
60	Current feedback into the inverter is detected.	<ol style="list-style-type: none"> 1. Restart the inverter. 2. Check if L/N cables are not connected reversely in all inverters. 3. For parallel system in single phase, make sure the sharing are connected in all inverters. For supporting three-phase system, make sure the sharing cables are connected in the inverters in the same phase, and disconnected in the inverters in different phases. 4. If the problem remains, please contact your installer.
71	The firmware version of each inverter is not the same.	<ol style="list-style-type: none"> 1. Update all inverter firmware to the same version. 2. Check the version of each inverter via LCD setting and make sure the CPU versions are same. If not, please contact your instraller to provide the firmware to update. 3. After updating, if the problem still remains, please contact your installer.
72	The output current of each inverter is different.	<ol style="list-style-type: none"> 1. Check if sharing cables are connected well and restart the inverter. 2. If the problem remains, please contact your installer.
80	CAN data loss	<ol style="list-style-type: none"> 1. Check if communication cables are connected well and restart the inverter. 2. If the problem remains, please contact your installer.
81	Host data loss	
82	Synchronization data loss	
83	The battery voltage of each inverter is not the same.	<ol style="list-style-type: none"> 1. Make sure all inverters share same groups of batteries together. 2. Remove all loads and disconnect AC input and PV input. Then, check battery voltage of all inverters. If the values from all inverters are close, please check if all battery cables are the same length and same material type. Otherwise, please contact your installer to provide SOP to calibrate battery voltage of each inverter. 3. If the problem still remains, please contact your installer.
84	AC input voltage and frequency are detected different.	<ol style="list-style-type: none"> 1. Check the utility wiring connction and restart the inverter. 2. Make sure utility starts up at same time. If there are breakers installed between utility and inverters, please be sure all breakers can be turned on AC input at same time. 3. If the problem remains, please contact your installer.
85	AC output current unbalance	<ol style="list-style-type: none"> 1. Restart the inverter. 2. Remove some excessive loads and re-check load information from LCD of inverters. If the values are different, please check if AC input and output cables are in the same length and material type. 3. If the problem remains, please contact your installer.
86	AC output mode setting is different.	<ol style="list-style-type: none"> 1. Switch off the inverter and check LCD setting #28. 2. For parallel system in single phase, make sure no 3P1, 3P2 or 3P3 is set on #28. For upporting three-phase system, make sure no "PAL" is set on #28. 3. If the problem remains, please contact your installer.

Appendix II: BMS Communication Installation

1. Introduction

This BMS communication cable delivers information and signal between lithium battery and the inverter. These information are listed below:

- Re-configure charging voltage, charging current and battery discharge cut-off voltage according to the lithium battery parameters.
- Have the inverter start or stop charging according to the status of lithium battery.

2. Pin Assignment for BMS Communication Port

	Definition
PIN 1	RS232TX
PIN 2	RS232RX
PIN 3	RS485B
PIN 4	NC
PIN 5	RS485A
PIN 6	CANH
PIN 7	CANL
PIN 8	GND

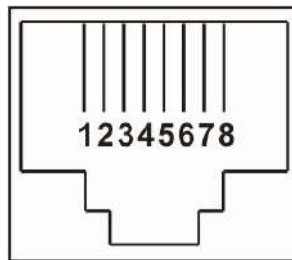

3. Lithium Battery Communication Configuration

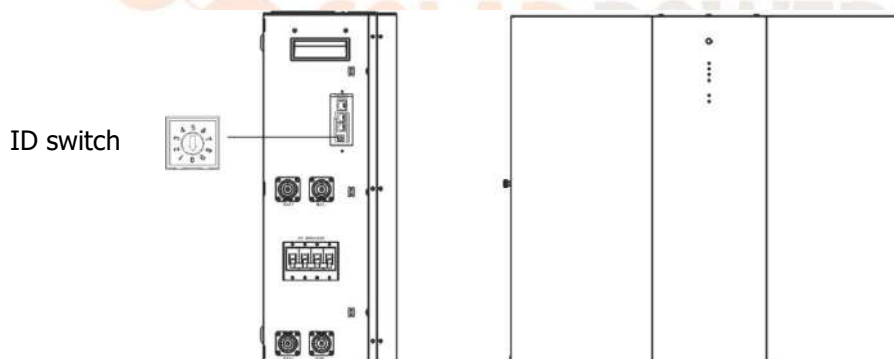

ID Switch indicates the unique ID code for each battery module. It's required to assign a unique ID to each battery module for normal operation. We can set up the ID code for each battery module by rotating the PIN number on the ID switch. From number 0 to 9, the number can be random; no particular order. Maximum 10 battery modules can be operated in parallel.

4. Installation and Operation

After ID no. is assigned for each battery module, please set up LCD panel in inverter and install the wiring connection as following steps.

Step 1: Use supplied RJ11 signal cable to connect into the extension port (P1 or P2).

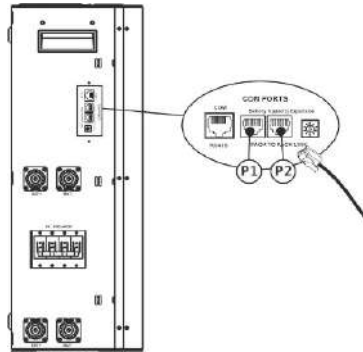

Step 2: Use supplied BMS cable (from battery module package) to connect inverter and Lithium battery.

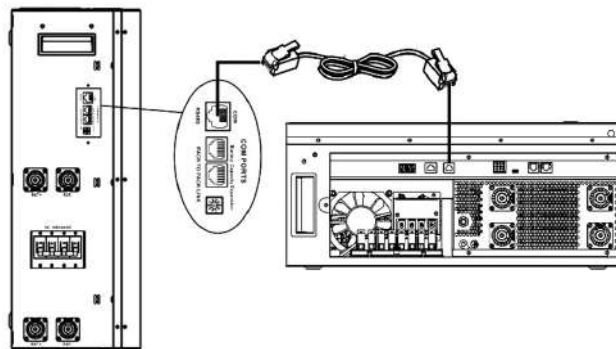

Note for parallel system:

1. Only support common battery installation.

Step 3: Turn the breaker switch "ON". Now, the battery module is ready for DC output.

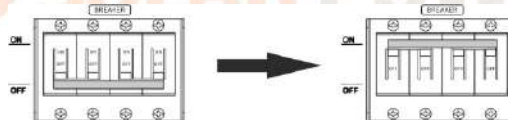

Step 4: Press Power on/off button on battery module for 5 secs, the battery module will start up.

Step 5: Turn on the inverter.

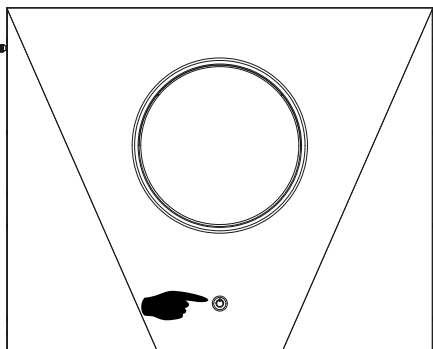

If communication between the inverter and battery is successful, the battery icon  on LCD display will flash. Generally speaking, it will take longer than 1 minute to establish communication.

Active Function

This function is to activate lithium battery automatically while commissioning. After battery wiring and commissioning is successfully, if battery is not detected, the inverter will automatically activate battery if the inverter is powered on.



5. LCD Display Information

Press “▲” or “▼” button to switch LCD display information. It will show battery pack and battery group number before “Main CPU version checking” as shown below.

Selectable information	LCD display
Battery pack numbers & Battery group numbers	<p>Battery pack numbers = 3, battery group numbers = 1</p>

6. Code Reference

Related information code will be displayed on LCD screen. Please check inverter LCD screen for the operation.

Code	Description
60	If battery status is not allowed to charge and discharge after the communication between the inverter and battery is successful, it will show code 60 to stop charging and discharging battery.
61	<p>Communication lost (only available when the battery type is not setting as “AGM”, “Flooded” or “User-Defined”).</p> <ul style="list-style-type: none"> After battery is connected, communication signal is not detected for 3 minutes, buzzer will beep. After 10 minutes, inverter will stop charging and discharging to lithium battery. Communication lost occurs after the inverter and battery is connected successfully, buzzer beeps immediately.
62	Internal communication failure of batteries.
69	If battery status is not allowed to charge after the communication between the inverter and battery is successful, it will show code 69 to stop charging battery.
70	If battery status must to be charged after the communication between the inverter and battery is successful, it will show code 70 to charge battery.
71	If battery status is not allowed to discharge after the communication between the inverter and battery is successful, it will show code 71 to stop discharging battery.

Appendix III: The Wi-Fi Operation Guide in Remote Panel

1. Introduction

Wi-Fi module can enable wireless communication between off-grid inverters and monitoring platform. Users have complete and remote monitoring and controlling experience for inverters when combining Wi-Fi module with WatchPower APP, available for both iOS and Android based device. All data loggers and parameters are saved in iCloud.

The major functions of this APP:

- Delivers device status during normal operation.
- Allows to configure device setting after installation.
- Notifies users when a warning or alarm occurs.
- Allows users to query inverter history data.

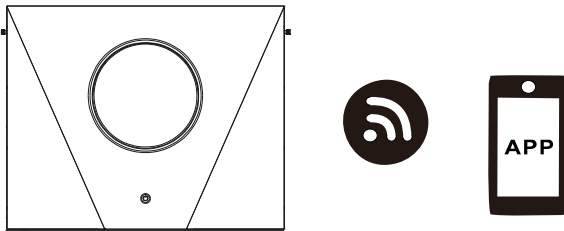

2. WatchPower App

2-1. Download and install APP

Operating system requirement for your smart phone:

🍏 iOS system supports iOS 9.0 and above

🤖 Android system supports Android 5.0 and above

Please scan the following QR code with your smart phone and download WatchPower App.



Android
system





iOS system

Or you may find "WatchPower" app from the Apple® Store or "WatchPower Wi-Fi" in Google® Play Store.



2-2. Initial Setup

Step 1: Registration at first time

After the installation, please tap the shortcut icon  to access this APP on your mobile screen. In the screen, tap "Register" to access "User Registration" page. Fill in all required information and scan the Wi-Fi module PN by tapping  icon. Or you can simply enter PN directly. Then, tap "Register" button.



Don't have an account? Please [Register](#)

Then, a "Registration success" window will pop up. Tap "Go now" to continue setting local Wi-Fi network connection.



Step 2: Local Wi-Fi Module Configuration

Now, you are in "Wi-Fi Config" page. There are detailed setup procedure listed in "How to connect?" section and you may follow it to connect Wi-Fi.

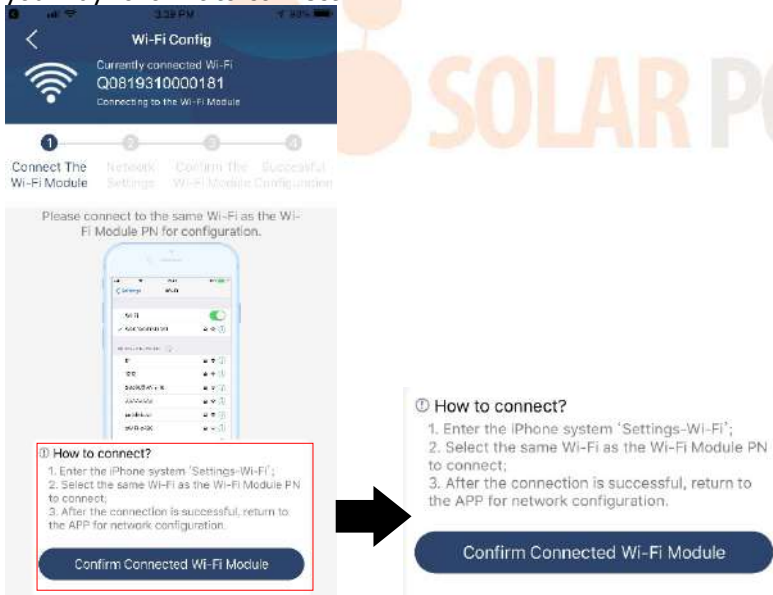

Enter the "Settings→Wi-Fi" and select connected Wi-Fi name. The connected Wi-Fi name is the same to your Wi-Fi PN number and enter default password "12345678".



Then, return to WatchPower APP and tap “ **Confirm Connected Wi-Fi Module** ” button when Wi-Fi module is connected successfully.

Step 3: Wi-Fi Network settings

Tap  icon to select your local Wi-Fi router name (to access the internet) and enter password.



Step 4: Tap “Confirm” to complete the Wi-Fi configuration between the Wi-Fi module and the Internet.

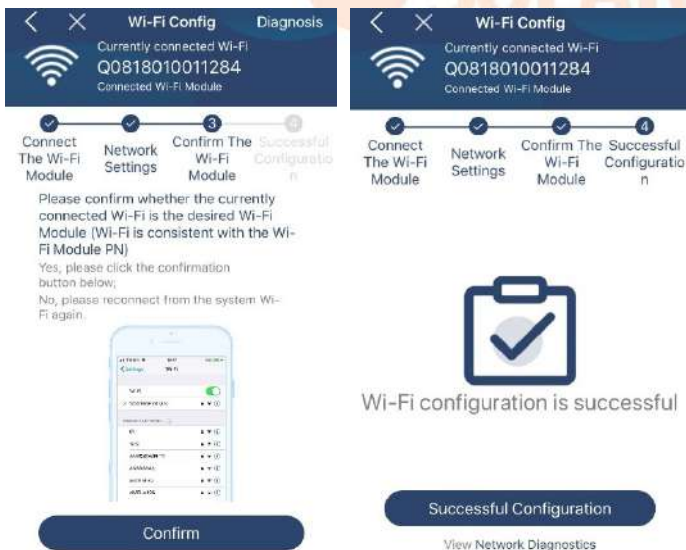

If the connection fails, please repeat Step 2 and 3.

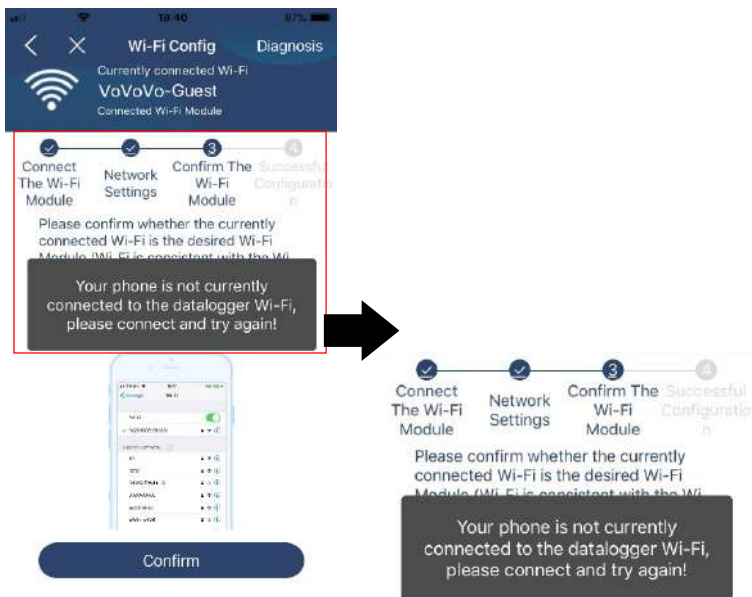

Diagnose Function

If the module is not monitoring properly, please tap "Diagnosis" on the top right corner of the screen for further details. It will show repair suggestion. Please follow it to fix the problem. Then, repeat the steps in the chapter 4.2 to re-set network setting. After all setting, tap "Rediagnosis" to re-connect again.

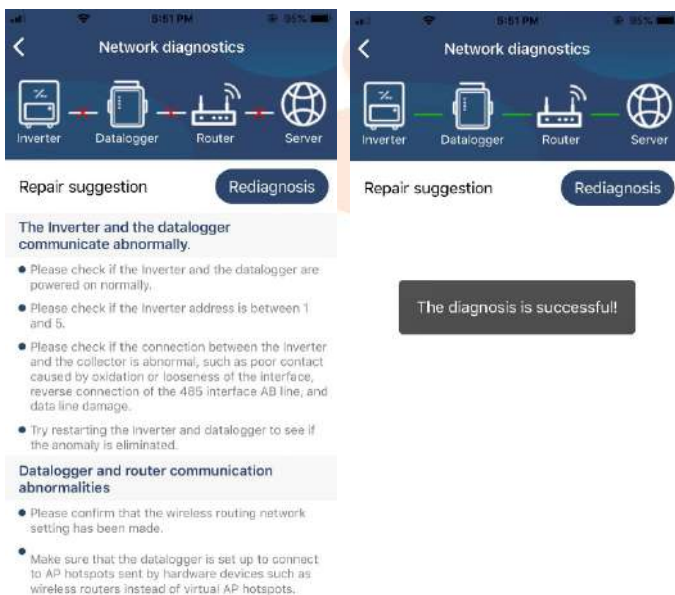

2-3.Login and APP Main Function

After finishing the registration and local Wi-Fi configuration, enter registered name and password to login. Note: Tick "Remember Me" for your login convenience afterwards.



V 1.0.0

Cloud Walker



Remember Me

Login

Wi-Fi Config

Overview

After login is successfully, you can access "Overview" page to have overview of your monitoring devices, including overall operation situation and Energy information for Current power and Today power as below diagram.



Devices

Tap the  icon (located on the bottom) to enter Device List page. You can review all devices here by adding or deleting Wi-Fi Module in this page.

Add device



Delete device

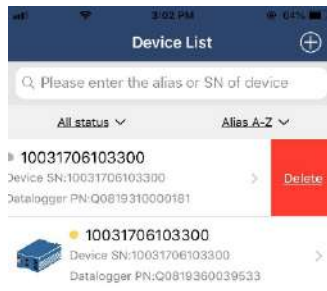

Tap  icon on the top right corner and manually enter part number to add device. Or you may simply scan QR code label. No matter it's part number or QR code, the label is pasted nearby wireless antenna. After entering part number, tap "Confirm" to add this device in the Device list.

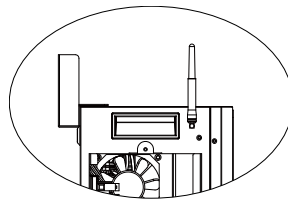
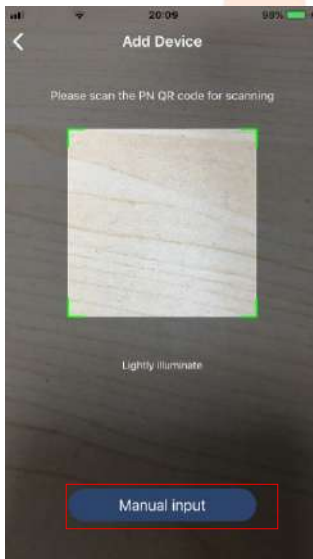

Part number or QR code label is pasted nearby wireless antenna.

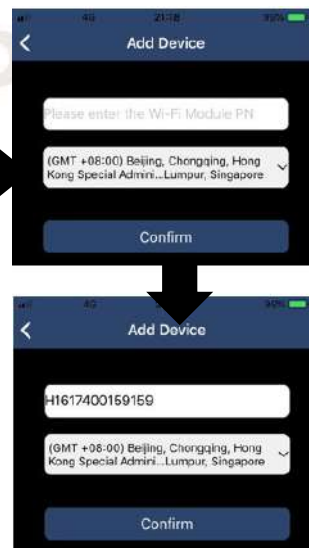

For more information about Device List, please refer to the section 2.4.

ME

In ME page, users can modify "My information", including **【User's Photo】**, **【Account security】**, **【Modify password】**, **【Clear cache】**, and **【Log-out】**, shown as below diagrams.

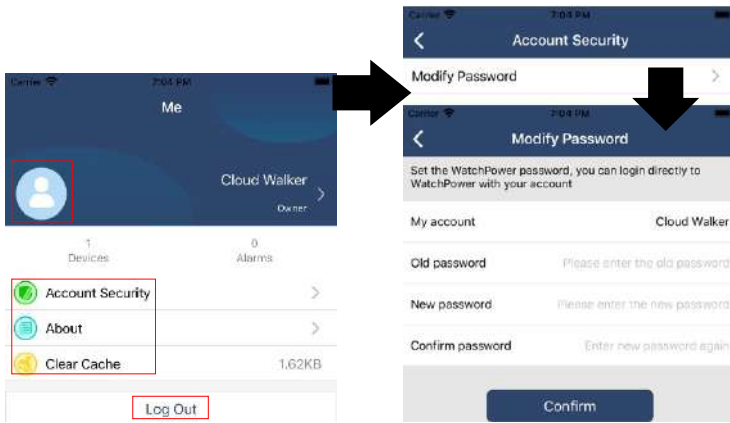

2-4. Device List

In Device List page, you can pull down to refresh the device information and then tap any device you want to check up for its real-time status and related information as well as to change parameter settings. Please refer to the parameter setting list.

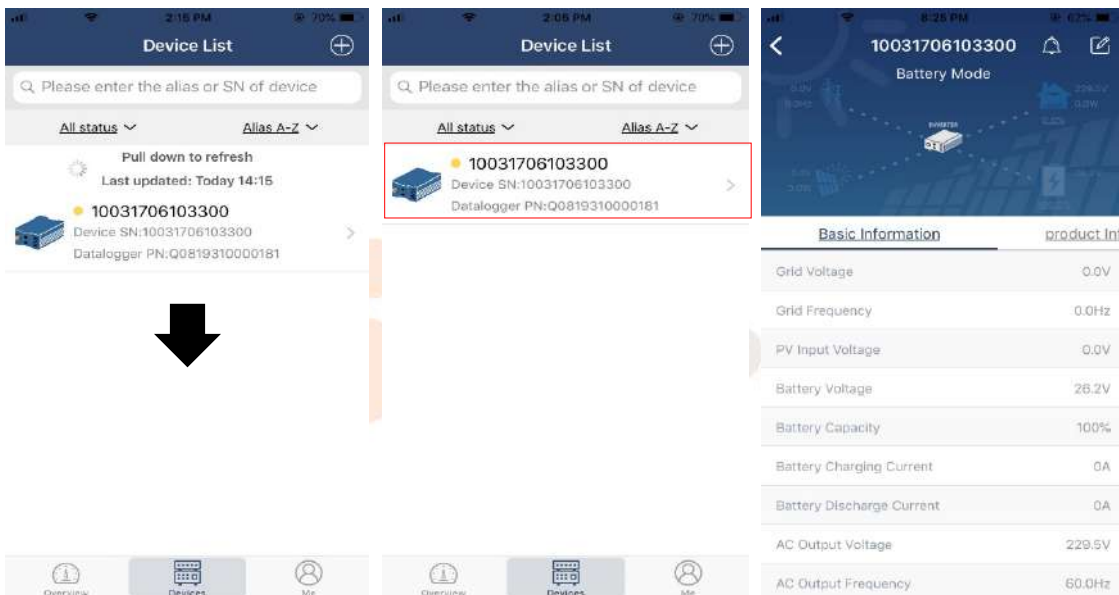

Device Mode

On the top of screen, there is a dynamic power flow chart to show live operation. It contains five icons to present PV power, inverter, load, utility and battery. Based on your inverter model status, there will be **Standby Mode** , **Line Mode** , **Battery Mode** .

Standby Mode Inverter will not power the load until "ON" switch is pressed. Qualified utility or PV source can charge battery in standby mode.



Line Mode Inverter will power the load from the utility with or without PV charging. Qualified utility or PV source can charge battery.

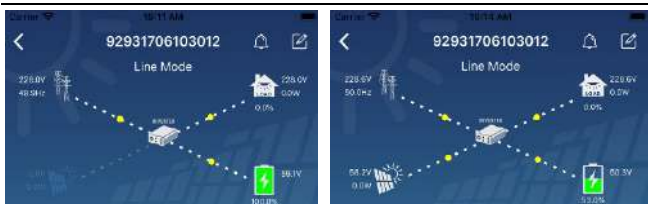

【Battery Mode】 Inverter will power the load from the batter with or without PV charging. Only PV source can charge battery.

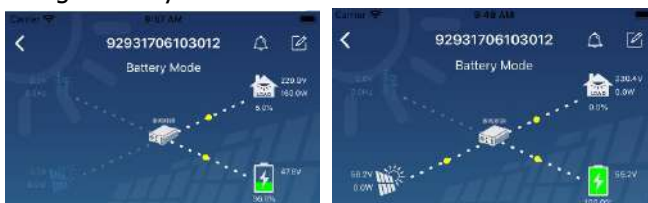

Device Alarm and Name Modification

In this page, tap the icon on the top right corner to enter the device alarm page. Then, you can review alarm history and detailed information. Tap the icon on the top right corner, a blank input box will pop out. Then, you can edit the name for your device and tap "Confirm" to complete name modification.

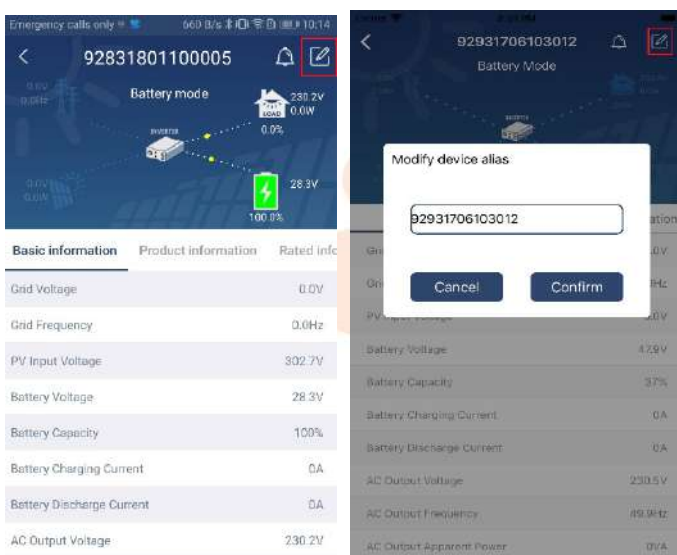

Device Information Data

Users can check up **【Basic Information】** , **【Product Information】** , **【Rated information】** , **【History】** , and **【Wi-Fi Module Information】** by swiping left.

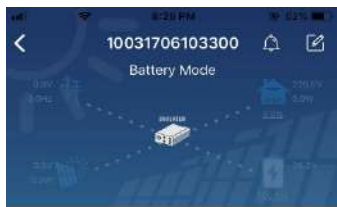

Basic Information	product info
Grid Voltage	0.0V
Grid Frequency	0.0Hz
PV Input Voltage	0.0V
Battery Voltage	28.2V
Battery Capacity	100%
Battery Charging Current	0A
Battery Discharge Current	0A
AC Output Voltage	229.5V
AC Output Frequency	60.0Hz

← Swipe left

【Basic Information】 displays basic information of the inverter, including AC voltage, AC frequency, PV input voltage, Battery voltage, Battery capacity, Charging current, Output voltage, Output frequency, Output apparent power, Output active power and Load percent. Please slide up to see more basic information.

【Production Information】 displays Model type (Inverter type), Main CPU version, Bluetooth CPU version and secondary CPU version.

【Rated Information】 displays information of Nominal AC voltage, Nominal AC current, Rated battery voltage, Nominal output voltage, Nominal output frequency, Nominal output current, Nominal output apparent power and Nominal output active power. Please slide up to see more rated information.

【History】 displays the record of unit information and setting timely.

【Wi-Fi Module Information】 displays of Wi-Fi Module PN, status and firmware version.

Parameter Setting

This page is to activate some features and set up parameters for inverters. Please be noted that the listing in "Parameter Setting" page in below diagram may differ from the models of monitored inverter. Here will briefly highlight some of it, **【Output Setting】**, **【Battery Parameter Setting】**, **【Enable/ Disable items】**, **【Restore to the defaults】** to illustrate.



There are three ways to modify setting and they vary according to each parameter.

- a) Listing options to change values by tapping one of it.
- b) Activate/Shut down functions by clicking "Enable" or "Disable" button.

c) Changing values by clicking arrows or entering the numbers directly in the column.
Each function setting is saved by clicking "Set" button.

Please refer to below parameter setting list for an overall description and be noted that the available parameters may vary depending on different models. Please always see the original product manual for detailed setting instructions.

Parameter setting list:

Item		Description
Output setting	Output source priority	To configure load power source priority.
	AC input range	When selecting "UPS", it's allowed to connect personal computer. Please check product manual for details.
		When selecting "Appliance", it's allowed to connect home appliances.
	Output voltage	To set output voltage.
Output frequency	To set output frequency.	
Battery parameter setting	Battery type:	To set connected battery type.
	Battery cut-off SOC	To set the battery stop discharging SOC. Please see product manual for the recommended SOC range based on connected battery type.
	Back to grid SOC	When "SBU" or "SOL" is set as output source priority and battery voltage is lower than this setting SOC, unit will transfer to line mode and the grid will provide power to load.
	Back to discharge SOC	When "SBU" or "SOL" is set as output source priority and battery voltage is higher than this setting SOC, battery will be allowed to discharge.
	Charger source priority:	To configure charger source priority.
	Max. charging current	It's to set up battery charging parameters. The selectable values in different inverter model may vary. Please see product manual for the details.
	Max. AC charging current:	
	Float charging voltage	
	Bulk charging voltage	
	Battery equalization	Enable or disable battery equalization function.
	Real-time Activate Battery Equalization	It's real-time action to activate battery equalization.
	Equalized Time Out	To set up the duration time for battery equalization.
	Equalized Time	To set up the extended time to continue battery equalization.
Equalization Period	To set up the frequency for battery equalization.	

	Equalization Voltage	To set up the battery equalization voltage.
Enable/Disable Functions	LCD Auto-return to Main screen	If enable, LCD screen will return to its main screen after one minute automatically.
	Fault Code Record	If enabled, fault code will be recorded in the inverter when any fault happens.
	Backlight	If disabled, LCD backlight will be off when panel button is not operated for 1 minute.
	Bypass Function	If enabled, unit will transfer to line mode when overload happened in battery mode.
	Beeps while primary source interrupt	If enabled, buzzer will alarm when primary source is abnormal.
	Over Temperature Auto Restart	If disabled, the unit won't be restarted after over-temperature fault is solved.
	Overload Auto Restart	If disabled, the unit won't be restarted after overload occurs.
	Buzzer	If disabled, buzzer won't be on when alarm/fault occurred.
RGB LED Setting	Enable/disable	Turn on or off RGB LEDs
	Brightness	Adjust the lighting brightness
	Speed	Adjust the lighting speed
	Effects	Change the light effects
	Color Selection	Adjust color by setting RGB value
Restore to the default	This function is to restore all settings back to default settings.	