

USER MANUAL

ECO Hybrid Inverter
SNA 3000-6000W WPV



— *Where sun shined*

Power always on —

SOLAR POWER 24



Monitor APP Download



Android



iOS

Version: SNA-EN-UM-2.0-00 PN:092.20024AA



LU X POWER^{TEK}

www.luxpowertek.com

info@luxpowertek.com

LUX POWER TECHNOLOGY CO., LTD

LU X POWER^{TEK}

Table Of Contents

Information on this Manual	01	3. Working Modes	15
Validity	01	3.1 Offgrid modes introduction	15
Scope	01	3.2 Working modes related setting description	17
Target Group	01	3.3 Working as a hybrid inverter. Related setting	19
Safety Instructions	01	4. LCD Display and settings	20
1. Brief Introduction	02	4.1 LED Display	20
1.1 Features of the inverter	02	4.2 LCD Display	21
1.2 Interface of the inverter	03	4.3 Inverter Status Display	22
1.3 Packing list	04	4.4 LCD Settings	23
2. Installation	05	5. Monitor System for Offgrid	33
2.1 Preparation	05	6. Specifications	34
2.2 Mounting the Unit	06	7. Trouble Shooting & Error List	38
2.3 Battery Connection	07		
2.3.1 Battery Power Cable Connection	07		
2.3.2 Lithium Battery Connection	08		
2.4 CT	08		
2.5 AC Input/Output Connection	10		
2.6 PV Connection	11		
2.7 Generator Connection	12		
2.8 Dry Contact Signal control	13		
2.9 Parallel function	13		
2.10 Power ON/OFF	15		

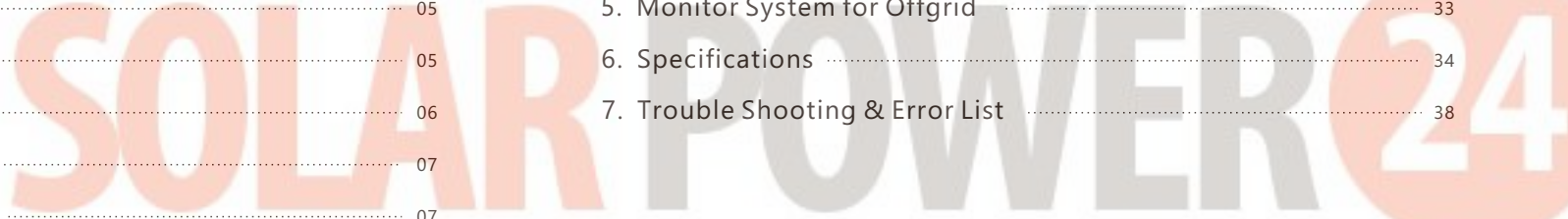

Information on this Manual

Validity

This manual is valid for the following devices: SNA3000 WPV/SNA4000 WPV/SNA5000 WPV/SNA6000 WPV

Scope

This manual provides the installation, operation and troubleshooting of this unit, please read this manual carefully before installations and operations.

Target Group

For qualified persons and end users. Qualified persons and end users must have the following skills:

- Knowledge about this unit operation
- Training in deal with the security issues associated with installations and electrical safety
- Training in the installation and commissioning of electrical devices and installations
- Knowledge of the applicable local standards and directives

Safety Instructions

WARNING: This chapter contains important safety and operating instructions. Read and keep this manual for future reference.

- All the operation and connection need to be operated by qualified persons.
- Before using the unit, read all instructions and cautionary marking on the unit. Any damage caused by inappropriate operation is not warranted by Luxpower.
- All the electrical installation must comply with the local electrical safety standards.
- Do not disassemble the unit. Take it to a qualified service center when service or repair is required, incorrect re-assembly may result in a risk of electric shock or fire. Do not open inverter cover or change any components without Luxpower's authorization, otherwise the warranty commitment for the inverter will be invalid.
- To reduce risk of electric shock, disconnect all wirings before attempting any maintenance or cleaning, turning off the unit will not reduce this risk.
- CAUTION-To reduce risk of injury, charge only deep-cycle lead-acid type rechargeable batteries and lithium batteries, other types of batteries may burst, causing personal injury and damage.
- NEVER charge a frozen battery.
- For optimum operation of this unit, please follow required spec to select appropriate cable size and breaker.
- Please strictly follow installation procedure when you want to disconnect AC or DC terminals, please refer to INSTALLATION section of this manual for the details.
- GROUNDING INSTRUCTIONS -This unit should be connected to a permanent grounded wiring system, be sure to comply with local requirements and regulation to install this inverter.
- NEVER cause AC output and DC input short circuited. Do not connect to the mains when DC input short circuits.

1. Brief Introduction

1.1 Features of the inverter

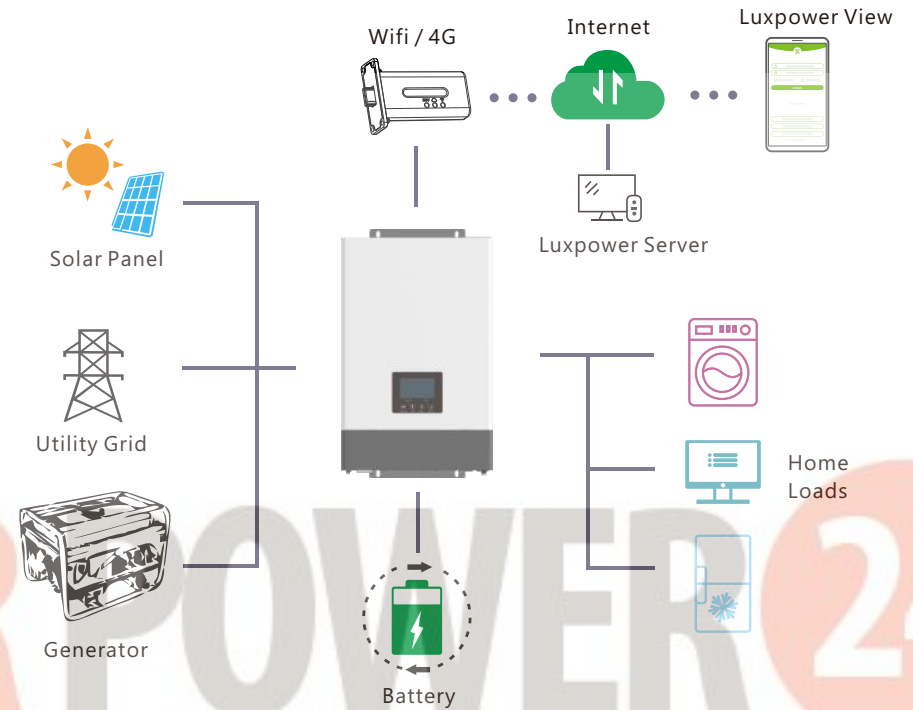

SNA series is a multifunctional, high frequency pure sine wave ECO Hybrid inverter solar inverter, features:

- Applicable for pure off grid inverter/ backup power / self-consumption / on grid situation
- Integrated with 2 MPPT solar charge controllers, MPPT ranges 120V~385V
- Rated power SNA5000WPV/5KW, SNA6000WPV/6KW, power factor 1
- Be able to run with or without battery in ongrid and offgrid mode
- With separated generator input interface, able to control generator remotely
- Solar and utility grid can power loads at the same time
- With integrated advanced parallel function, up to 16pcs max paralleling
- Support CAN/RS485 for Li-ion battery BMS communication
- WIFI/ GPRS remote monitoring , setting and firmware update, support website, free IOS/Android APP

1.2 Interface of the inverter

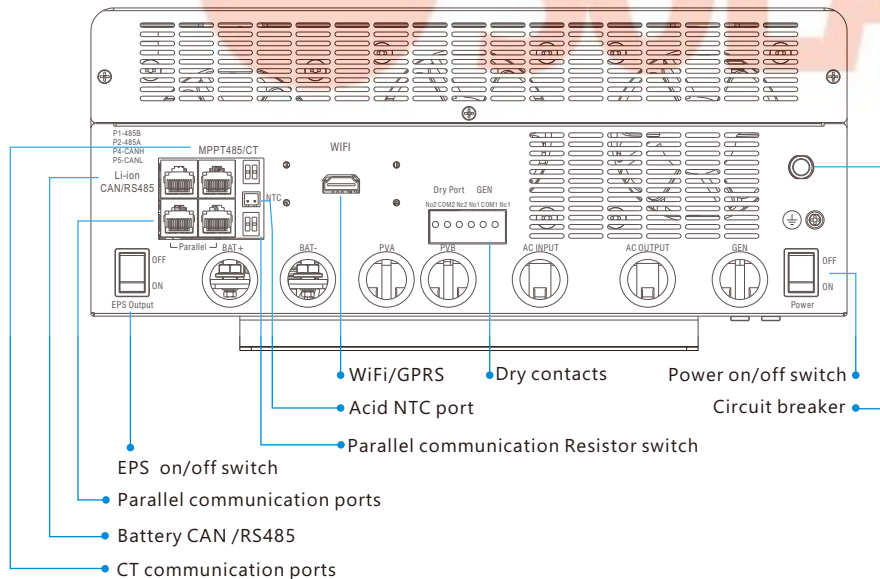
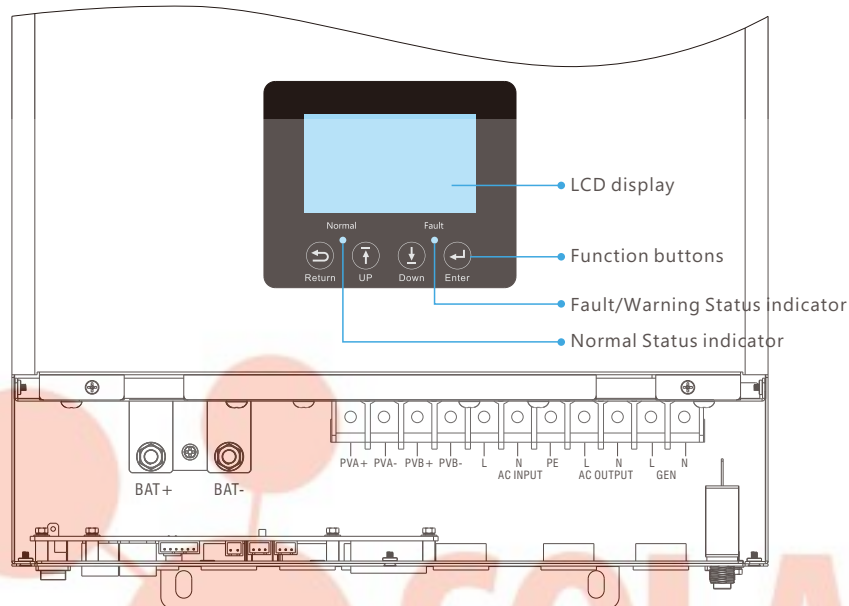

1.3 Packing List

Before installation, please inspect the unit. Be sure that nothing inside the package is damaged. You should have received the following items in the package:

ECO Hybrid inverter X1	User Manual X1	Expansion Screw and Tube X4	Wi-Fi Module X1	Cross Head Screw X5 / Nut X2	Soft Magnetic Strip X1

Storing the Inverter

The inverter must be stored appropriately if not installed immediately, refer to below figure.

CAUTION !

- The inverter and its components must be stored in its original packaging.
- The storage temperature should be within $-25\sim 60^{\circ}\text{C}$ and humidity within $0\sim 85\%$.
- The packing should be upright and maximum stacked layers is 6 .
- Do not directly exposed the inverter and its packaging to sunshine, raindrops and keep away from corrosion.

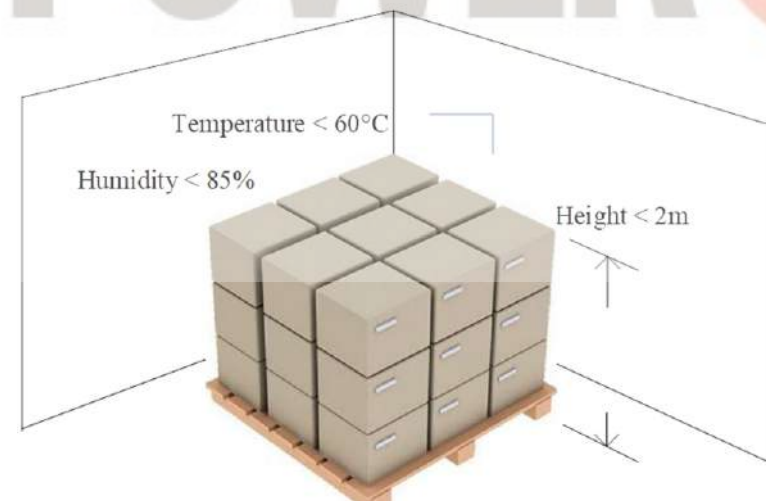

2. Installation

2.1 Preparation

The system connection is as below:

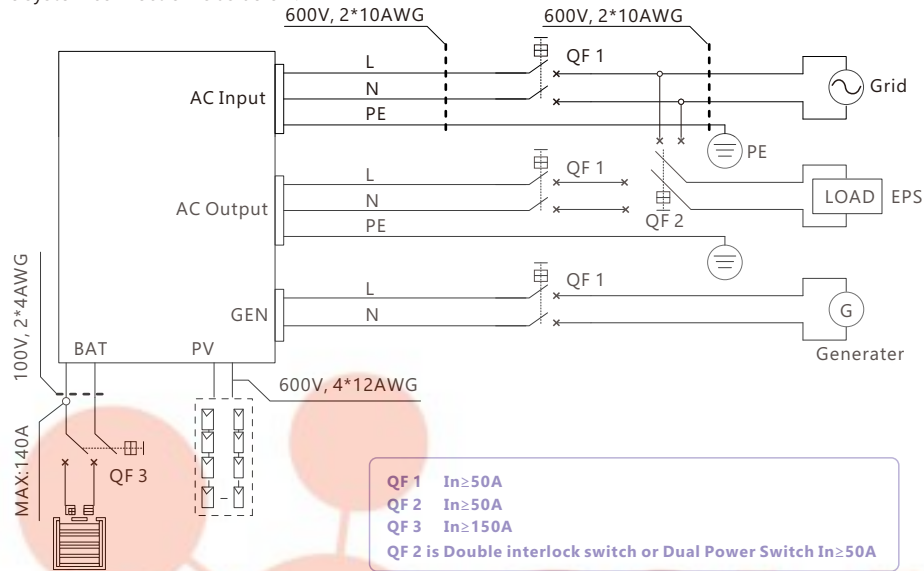

Please prepare the breakers and cables in advanced before installation.

1. Battery connection: For safety operation and regulation compliance, it's requested to install a separate DC over-current protector or disconnect device between battery and inverter. The recommend battery capacity is 150AH-200AH, the recommended spec of DC breaker is SNA5000WPV 150A/80V, SNA6000WPV 200A/80V. Recommended battery cable and terminal size:

Model	Maximum Amperage	Battery capacity	Wire Size	Ring Terminal		Torque value	
				Cable mm2	Dimensions D (mm) L (mm)		
SNA5000WPV	110A	≥200AH	1*2AWG	33	6.4 39.2	4~ 5 Nm	
SNA6000WPV	140A		1*1AWG	42	6.4 39.2		

2. AC connection: Please install a separate AC breaker between inverter and AC input power source, inverter and AC output load. This will ensure the inverter can be securely disconnected during maintenance and fully protected from over current of AC input. The recommended spec of AC breaker is 50A. Recommended AC input/ AC output /GEN cable size for each inverter.

Model	Gauge	Cable (mm2)	Torque Value
SNA5000WPV/6000WPV	10AWG	6	2.0 Nm

3. PV Connection: Please install separately a DC circuit breaker between inverter and PV modules. The recommended of DC breaker is 600V/25A. It's very important for system safety and efficient operation to use appropriate cable for PV module connection. To reduce risk of injury, please use the proper recommended cable size as below:

Model	Gauge	Cable (mm2)	Torque Value
SNA5000WPV/6000WPV	1x10AWG	6	2.0 Nm

4. Before connecting all wiring, please take off bottom cover by removing 3 screws as shown below.

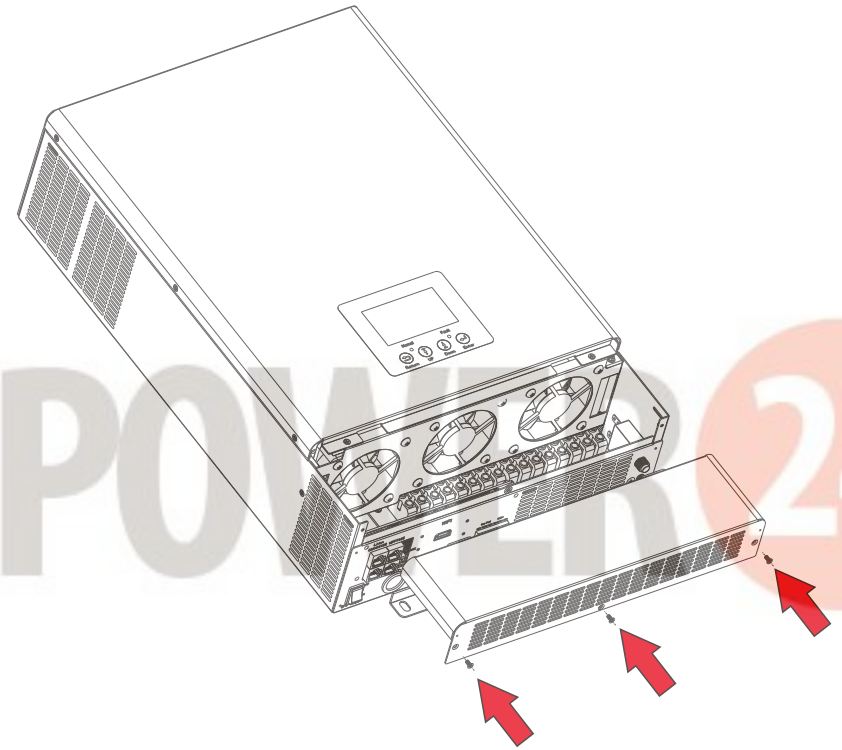

2.2 Mounting the Unit

Notice: Consider the following points before selecting where to install:

- Mount on a solid surface
- Do not mount the inverter on flammable construction materials.
- For proper air circulation to dissipate heat, allow a clearance of approx. 20 cm to the side and approx. 50 cm above and below the unit.
- The ambient temperature should be between 0°C and 55°C to ensure optimal operation.
- The recommended installation position is to be adhered to the wall vertically.

Steps to mounting the unit

Step1. Use the wall-mounting bracket as the template to mark the position of the 4 holes, then drill 8 mm holes and make sure the depth of the holes is deeper than 50mm.

Step2. Install the expansion tubes into the holes and tight them, then use the expansion screws (packaged together with the expansion tubes) to install and fix the wall-mounting bracket on the wall.

Step3. Install the inverter on the wall-mounting bracket and lock the inverter using the security screws.

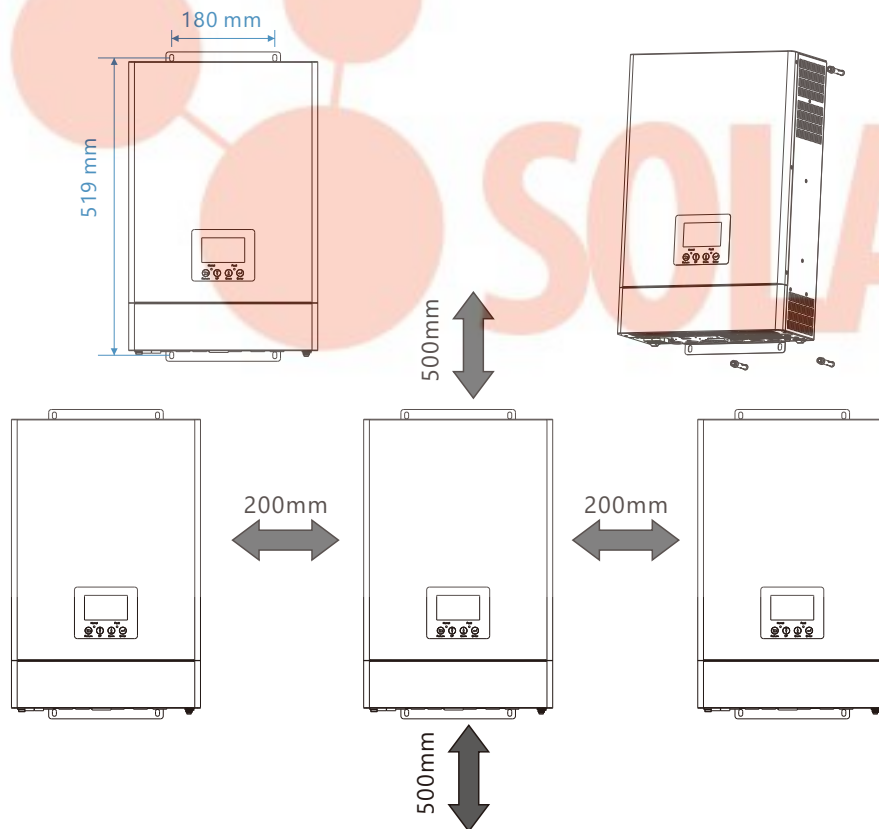

2.3 Battery Connection

2.3.1 Battery Power Cable Connection

Note: for lead acid battery, the recommended charge current is 0.2C (C to battery capacity)

1. Please follow below steps to implement battery connection:
2. Assemble battery ring terminal based on recommended battery cable and terminal size.
3. Connect all battery packs as units requires. It's suggested to connect at least 200Ah capacity battery for SNA5000WPV/ 6000WPV.
4. Insert the ring terminal of battery cable flatly into battery connector of inverter and make sure the bolts are tightened with torque of 4 ~5Nm. Make sure polarity of the battery is correctly connected and ring terminals are tightly screwed to the battery terminals.

2.3.2 Lithium Battery Connection

If choosing lithium battery for SNA series, please make sure the battery BMS is compatible with Luxpower inverter. Please check the compatible list in the Luxpower website.

Please follow below steps to implement lithium battery connection:

1. Connect power cable between inverter and battery
2. Connect the CAN or RS485 communication cable between inverter and battery. If you do not get the communication cable from inverter manufacturer or battery manufacturer, please make the cable according to the PIN definition
3. Lithium battery configuration, in order to communicate with battery BMS, you should set the battery type to "Li-ion" in Program "03" by LCD and choose the right battery brand (for details, please check the LCD setting chapter), users can also choose the battery type and brand by monitor system.

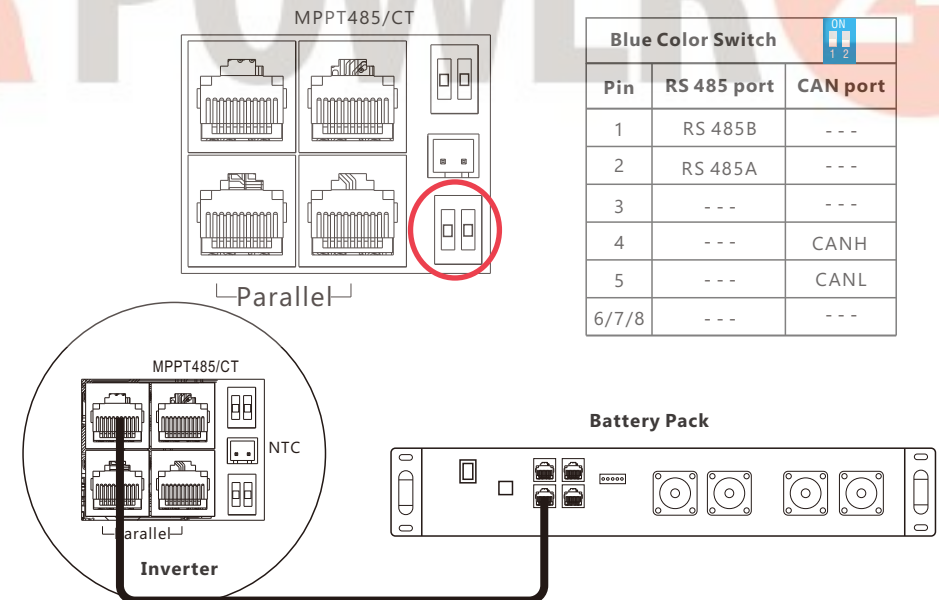

2.4 CT

To measure the power imported from and exported to the grid, a pair of Cts must be installed at the service entry point in or near the main service panel. External Grid CT" function is off by default, and if you need inverter to export power to compensate the grid loads, you can set "External Grid CT" function to "Enable" state. Please refer to section 4.4 LCD Settings for detected setting info.

CT Port Pin definition

The CT interface for CT connection is a RJ45 port

Pin	Description
	CT-L1
1/3	B
2/4	A
5	CT1N
6	CT1P
7	B2
8	A2

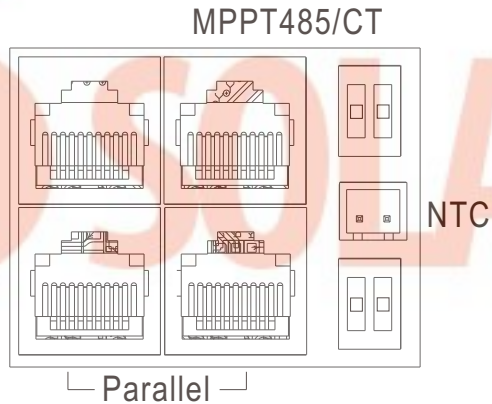

Please refer to the connection diagram for the correct positions of Grid CT and clamp the CT on the wires at the service entry point in the main service panel. The arrow on the CT is pointing to the inverter. (***) Incorrectly install CT will cause The Display to show incorrect information and features of the inverter will not function correctly) If the CT is in a wrong direction, there is an option you can change the direction of the CT on your inverter call: CT Direction Reversed in Advanced Tab. You would not need to go change it physically.

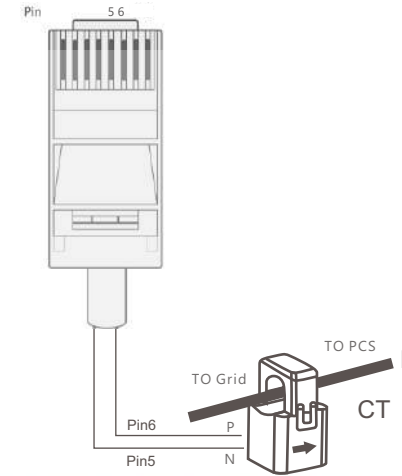

CT Clamp Ratio

The inverter support 3 ratios of CT clamp- **1000:1** ,**2000:1** and **3000:1** . The CT ratio of the CTs in the accessory bag is 3000:1. If you are using a 3rd party CT, please ensure the CT ratio is one of them, and select the correct CT ratio setting in the inverter monitor page or on the inverter LCD.

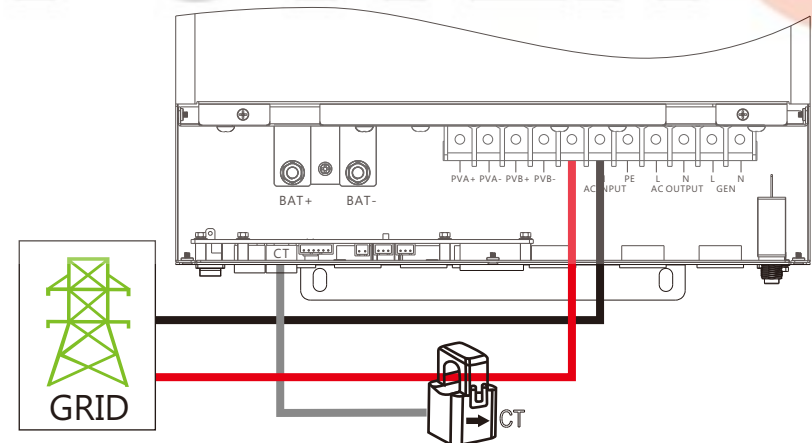

2.5 AC Input/Output Connection

CAUTION!!

- There are two terminal blocks with "IN" and "OUT" markings. Please do NOT mis-connect input and output connectors.
- Be sure to connect AC wires with correct polarity. If L and N wires are connected reversely, it may cause utility short-circuited when these inverters are worked in parallel operation.

Please follow below steps to implement AC input/output connection:

1. Before making AC input/output connection, be sure to open DC protector or disconnected first.
2. Remove insulation sleeve 10mm for six conductors. And shorten phase L and neutral conductor N 3 mm.
3. Insert AC input wires according to polarities indicated on terminal block and tighten the terminal screws. Be sure to connect PE protective conductor first.
4. Insert AC output wires according to polarities indicated on terminal block and tighten terminal screws. Be sure to connect PE protective conductor first.
5. Make sure the wires are securely connected.

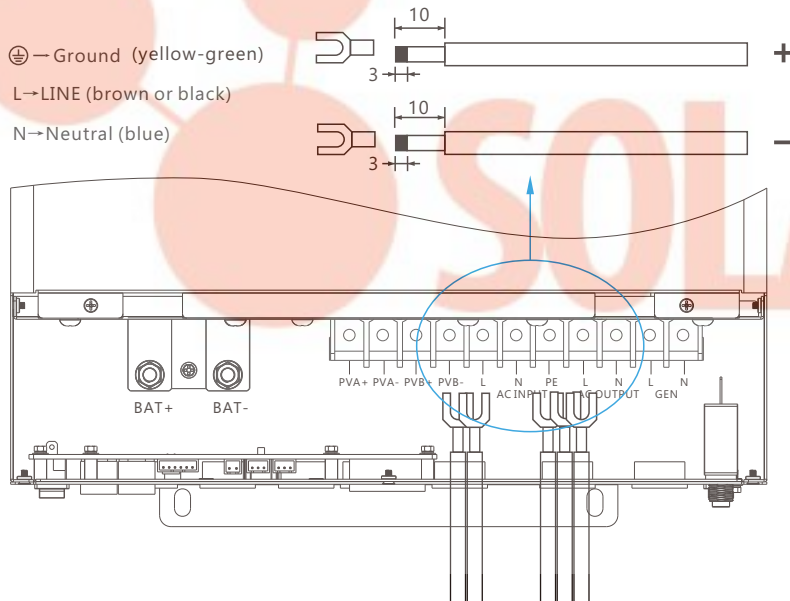

2.6 PV Connection

Please follow below steps to implement PV module connection:

1. Remove insulation sleeve 10 mm for positive and negative conductors.
2. Check correct polarity of connection cable from PV modules and PV input connectors.
3. Connect positive pole (+) of connection cable to positive pole (+) of PV input connector. Connect negative pole (-) of connection cable to negative pole (-) of PV input connector.
4. Make sure the wires are securely connected.

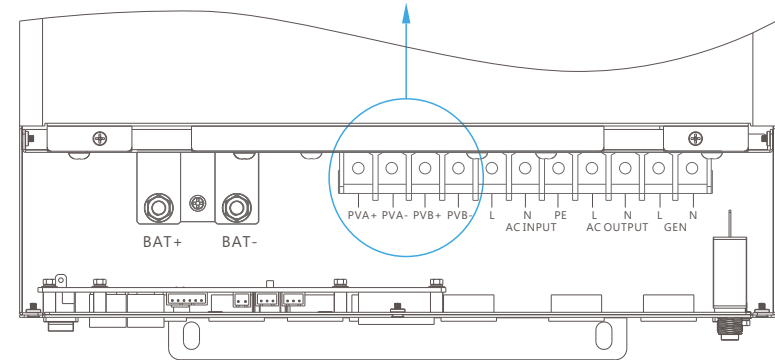

2.7 Generator Connection

L → LINE (brown or black) N → Neutral (blue)

1. Before making Generator connection, be sure to open DC protector or disconnected first.
2. Remove insulation sleeve 10mm for 2 conductors.
3. Insert L and N wires according to polarities indicated on terminal block and tighten the terminal screws.
4. Make sure the wires are securely connected.
5. Finally, after connecting all wiring, please put bottom cover back by screwing two screws as shown below.

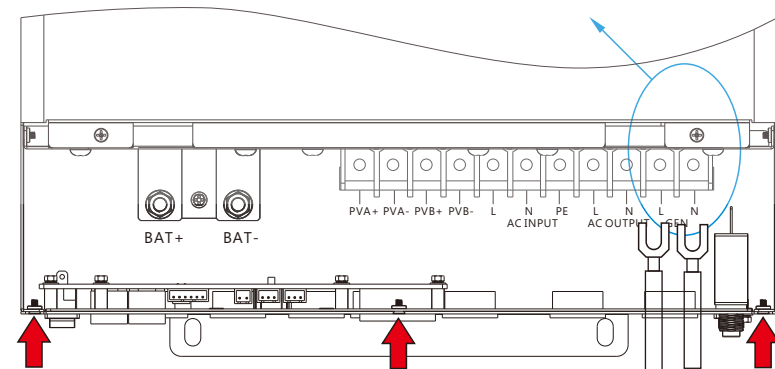

All lux units can work with generator:

- Users can connect the generator output to ECO hybrid inverters. GEN input terminal.
- The generator will be automatically started when battery voltage is lower than the cut-off value or there is charge request from BMS. When voltage is higher than AC charge setting value, it will stop the generator.
- Battery will get charged when the generator is turned on, and the generator is bypassed to AC output to take all loads.

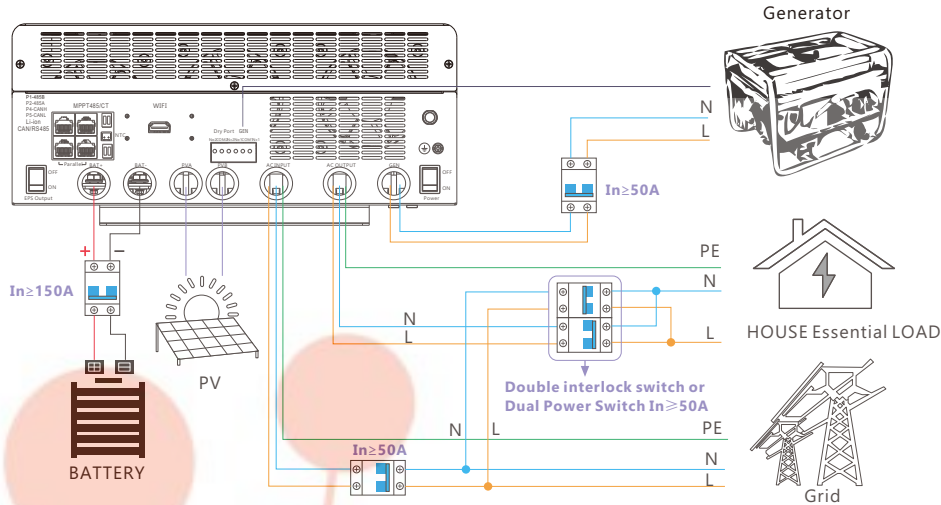

- The system will use AC first if there is both utility input and generator input.

The capacity of the generator is recommended

Number of the single parallel inverter	Capacity
Single inverter	> 10KW
2 parallel	> 15KW

It is supported to parallel 2~3 PCS inverter with single phase in single phase parallel system and three phase parallel system to charge battery with Generator! And it is depends on the load performance of the generator too.

2.8 Dry Contact Signal control

The Dry port(NO2,COM2) could be used to deliver signal to external device when battery voltage reaches warning level. The GEN port(NO1,COM1) could be used to wake-up the Generator and then the generator can charge the battery.

Unit Status	Condition	Dry port NO2 COM2	GEN NO1 COM1
		NO2 & COM2	NO1 & COM1
Power Off	Inverter is off and no output is powered.	Open	Open
Power On	Without Grid	Battery voltage < Low DC warning voltage	Close
		Battery voltage > Setting value or battery charging reaches floating stage	Open
	With Grid	Battery voltage < Low DC warning voltage	Close
		Battery voltage > Setting value or battery charging reaches floating stage	Open

Notice: NO---Normal open

Dry Port Relay Maximum Specification: 250VAC 5A

Gen Port Relay Maximum Specification: 250VAC 5A

2.9 Parallel function

SNA series inverter support up to 16 units to composed single phase parallel system or three phase parallel system, for parallel system setup

Step1. Cable connection: the system connection is as below:

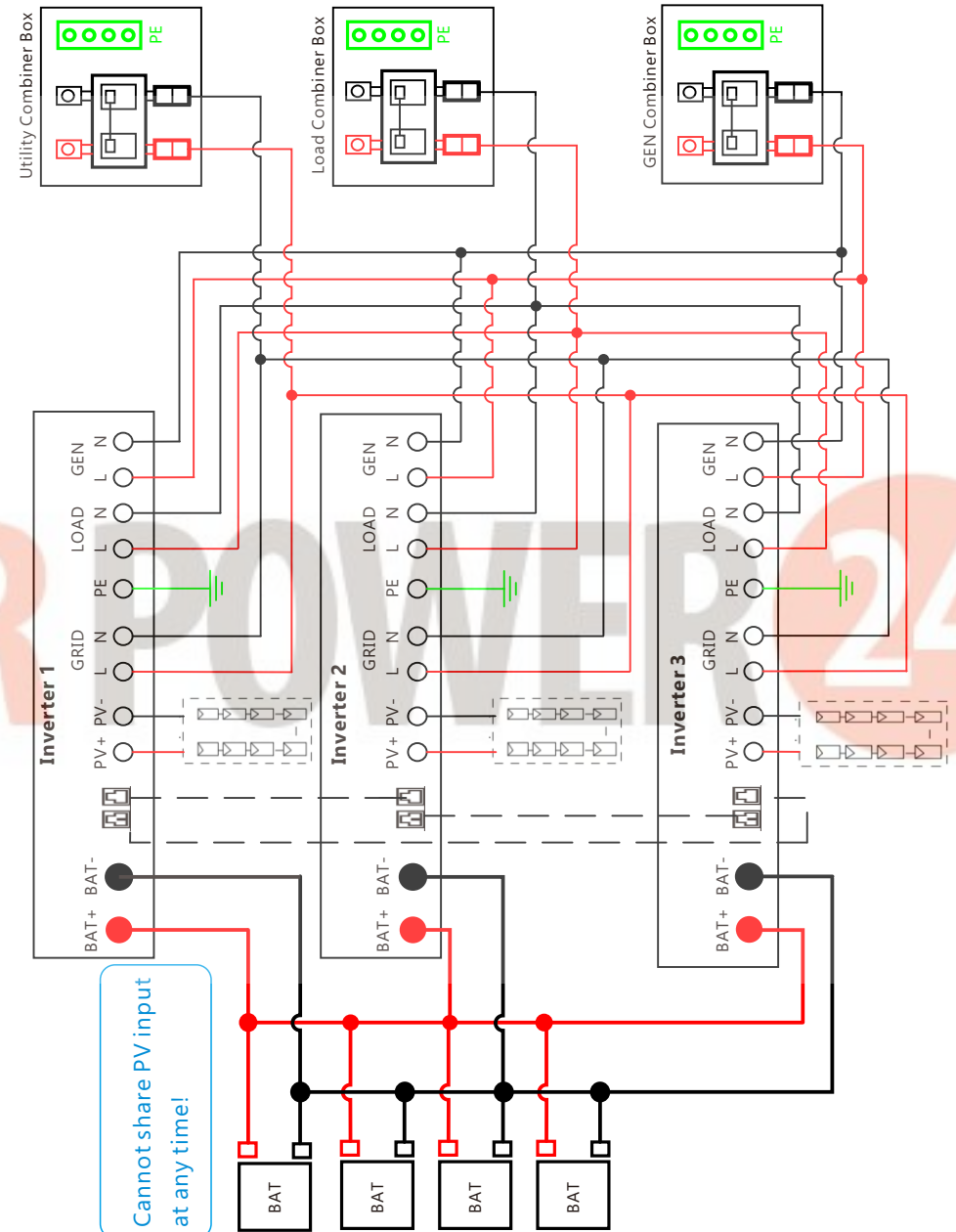

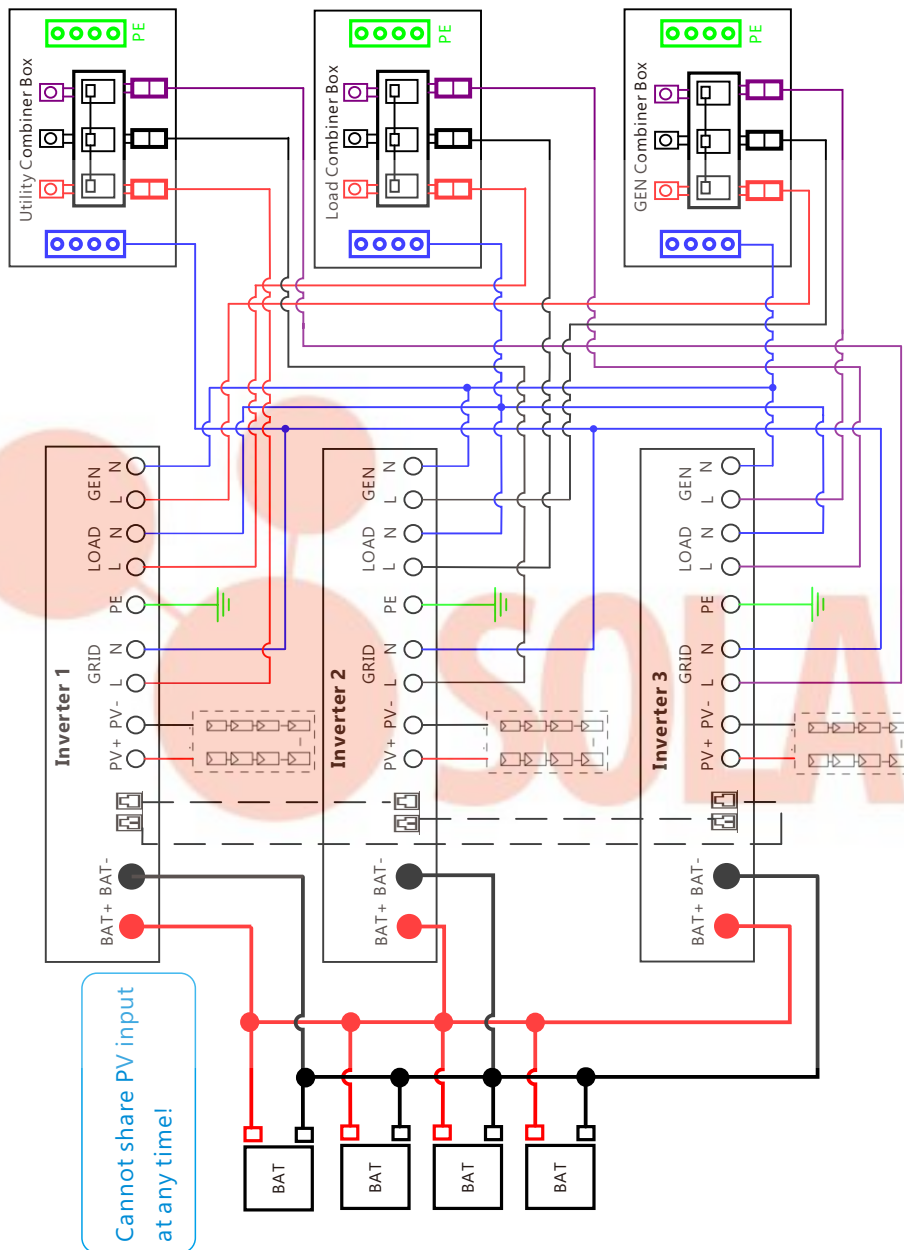

Step2. Please put the CAN communication PIN on on status for the first and the end inverter

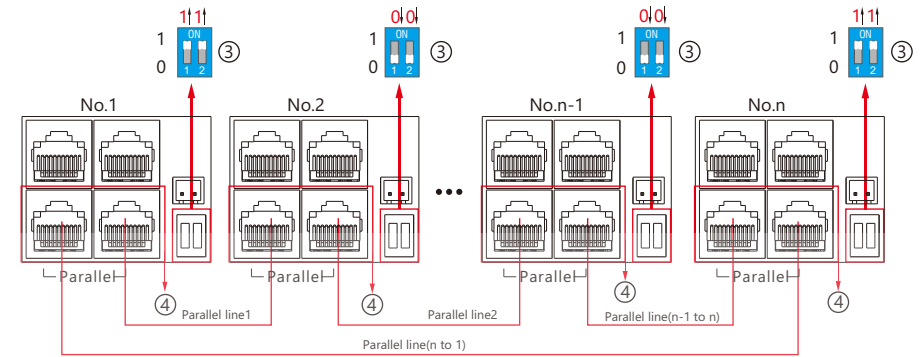

The max parallel quantity is 10, so $2 < n \leq 10$

Step3. Setup the monitor for the system, add all datalogs in one station. Users can login to the visit interface of monitor system, Configuration->station->Plant Management->add datalog to add the datalogs.

Plant name	Installer	End User	Country	Timezone	Daylight saving time	Create date	Action
1 Genesis	Aspergo Install	Aspergo Install	South Africa	GMT+2	No	2019-03-14	Plant Management
2 Butler Home	Elangeni	johnbutler	South Africa	GMT+2	No	2019-03-25	Plant Management
3 Office	Broomhead	cronje	South Africa	GMT+2	No	2019-06-03	Plant Management
4 Cronje Home	Broomhead	cronje	South Africa	GMT+2	No	2019-07-16	Plant Management

Step4. Enable share battery for the system if the system share one battery bank, otherwise disable the shared battery function

Step5. Set the system as a parallel group in the monitor system

Serial number	Status	Solar Power	Charge Power	Discharge Pow	Load	Solar Yielding	Battery Dischar	Feed Energy	Consumption E	Plant name	Parallel	Action
1 0272011008	Normal	228 W	42 W	0 W	182 W	215.3 kWh	39.6 kWh	0 kWh	551.2 kWh	Dragonview	A-1	Parallel
2 0272011011		35 W	32 W	0 W	0 W	158.7 kWh	21.1 kWh	0 kWh	160.5 kWh	Dragonview	A-2	Parallel
3 0272011012		1 kW	129 W	0 W	1 kW	170.3 kWh	49.9 kWh	0 kWh	434.5 kWh	Dragonview	A-3	Parallel
4 0272011017		79 W	48 W	0 W	106 W	99 kWh	85.6 kWh	0 kWh	257.1 kWh	Dragonview	A-4	Parallel

For more detailed guidance for paralleling system, please visit <https://www.luxpowertek.com/download/> And download the guidance

2.10 Power and EPS ON/OFF

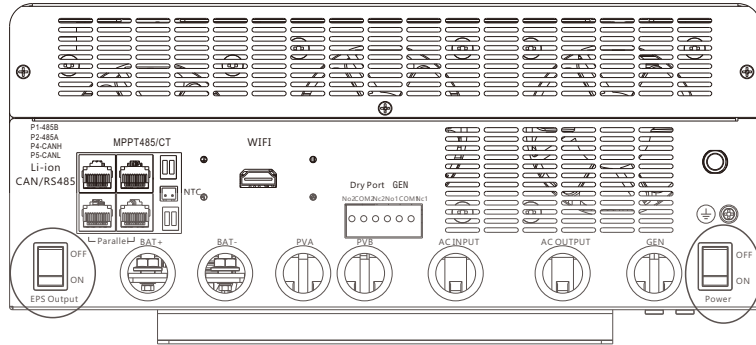

1. Power Switch: Control power supply for the unit
 2. EPS Output Switch: Use to control the AC output
- After connection, please turn on both switch. Users can turn off the EPS output switch to turn off power supply in some emergency case

3. Working modes

3.1 ECO Hybrid inverter modes introduction:

Bypass Mode		AC is used to take the load
PV Charge Bypass		PV charge the battery while the AC power the load
BAT Grid off		Battery is used to take the load
PV+BAT Grid off		PV+ Battery power the load together

PV Charge		<ol style="list-style-type: none"> 1. When the EPS key off, the inverter charge the battery only 2. When the battery is power off, the PV can wake up the battery automatically
PV Charge+Grid off		PV charge the battery and power the load
AC Charge		<ol style="list-style-type: none"> 1. AC charge the battery from AC Input or GEN Input 2. When the battery is power off, the AC can wake up the battery automatically
PV+AC charge		<p>PV+AC charge the battery</p> <p>AC is from AC Input or GEN Input</p>
PV Grid off		<p>NOTE: The output power depends on the PV energy input, if the PV energy is unstable, witch will influence the output power</p> <p>When setting without battery, the PV can power the load .</p>
PV charge Grid on		<p>PV charge battery and power the load</p> <p>*The rest power from PV can feed in Grid</p>
PV+BAT Grid on		PV+ Battery power the load , and the AC can power the load if PV+ Battery power not enough
PV Grid on		PV power the load, the rest power feed in Grid

3.2 Working Modes related setting description

Situation	Setting 1	Setting 2	Setting 3	Working modes and Description
AC abnormal	NA	NA	NA	off grid inverter mode if P_Solar >= P_load, solar is used to take load and charge battery if P_Solar < P_load, solar and battery take the load together, system will discharge until battery lower than the Cut Off Voltage/SOC
AC normal	PV&AC Take Load Jointly Enable	In the AC first time	NA	Hybrid Mode 1 (charge first) Solar power will be used to charge battery first. 1. The solar power will be used to charge the battery first. AC will take load. 2. If solar power is higher than power need to charge the battery, the extra power will be used to take load together with grid 3. If there is still more energy after charge battery and take the load, it will feed energy into grid if export to grid function is enabled
		Enable AC charge and in the AC charge time	AC charge according to Time	Hybrid Mode 1 (charge first) + AC charge battery if solar power is not enough to charge battery
		1. Not in the AC first time and 2. Disable AC charge or not in the AC charge time	NA	Hybrid Mode 1 (charge first) + AC charge battery if solar power is not enough to charge battery and the battery voltage/SOC is lower than AC start charge voltage/SOC, the AC will stop charging when the battery Voltage/SOC is higher than AC end charge battery voltage/SOC
AC normal	PV&AC Take Load Jointly Disable	In the AC first time	NA	Hybrid Mode 2 (load first) Solar power will be used to take load first. 1. If solar power is lower than load, battery will discharge together to take load until battery lower than EOD voltage/SOC 2. If solar power is higher than load, the extra power will be used to charge battery, if there is still more energy, it will feed into grid if enable export
		Enable AC charge and in the AC charge time	AC charge according to Time	Bypass Mode AC will take the load and Solar is used to charge battery
		1. Not in the AC first time and 2. Disable AC charge or not in the AC charge time	NA	Bypass Mode + AC charge battery / Solar is used to charge battery AC will take load and also charge battery during AC charge time if solar power is not enough
				Bypass Mode + AC charge battery Solar is used to charge battery AC will take load and also charge battery when battery SOC/Voltage is lower than start SOC /Voltage, and the AC will stop charging when the battery Voltage/SOC is higher than AC end charge battery voltage/SOC
				off grid inverter mode if P_Solar >= P_load, solar is used to take load and charge battery if P_Solar < P_load, solar and battery take the load together, system will discharge until battery lower than EOD Voltage/SOC

3.3 Working as a hybrid inverter. Related settings

3.3.1. SNA series can work as traditional off grid inverter or as a hybrid inverter. When disable PV&AC take load Jointly, it will work as a traditional off grid inverter, otherwise it will work as a hybrid working as a traditional off grid inverter. In this situation, inverter either use (solar+battery) to take load or use AC take load. Related setting.

Hybrid Setting

PV&AC Take Load Jointly

Grid CT Connection

Export to Grid

Export Power Percent(%)

3.3.2 AC First: During the setting time, system will use AC to take load, use solar power to charge the battery first. If there is extra solar power, extra solar power will take the load. When out of the setting time, system will use solar and battery to take load first until battery voltage/SOC is lower than On Grid EOD settings, then it will use AC to take the load.

Application Setting

EPS Voltage Set(V) EPS Frequency Set(Hz)

AC Input Range

AC First

AC first Start Time 1 : AC first Start Time 2 : AC first Start Time 3 :

AC first End Time 1 : AC first End Time 2 : AC first End Time 3 :

Discharge Setting

Discharge Control Discharge Current Limit(Ade)

Battery Warning Voltage(V) Battery Warning SOC(%)

Discharge Cut-off Voltage(V) Discharge Cut-off SOC(%)

On Grid EOD Voltage(V) On Grid EOD SOC(%)

3.3.3 AC Charge function Disable: The system will not use AC to charge the battery(except Li ion BMS set force charge flag)

AC Charge

AC Charge Based On AC Charge Battery Current(A)

AC Charge Start Time 1 : AC Charge Start Time 3 :

AC Charge End Time 1 : AC Charge End Time 3 :

AC Charge Start Battery Voltage AC Charge End Battery Voltage(V)

AC Charge Start Battery SOC(%) AC Charge End Battery SOC(%)

Dropdown menu options:

- According to Time: During the setting time, system will use AC to charge the battery until battery full and battery will not discharge during the setting time.
- According to Battery Voltage: During the setting voltage, system will use AC to charge the battery if battery voltage is lower than AC Charge Start Battery Voltage and will stop when Voltage is higher than AC Charge End Battery Voltage.
- According to Battery SOC: During the setting SOC, system will use AC to charge the battery if battery SOC is lower than AC Charge Start Battery SOC and will stop when Voltage is higher than AC Charge End Battery SOC.
- According to Battery Voltage and Time: During the setting time, system will use AC to charge the battery if battery voltage is lower than AC Charge Start Battery Voltage and will stop when Voltage is higher than AC Charge End Battery Voltage. And battery will not discharge during the setting time.
- According to Battery SOC and Time: During the setting time, system will use AC to charge the battery if battery SOC is lower than AC Charge Start Battery SOC and will stop when Voltage is higher than AC Charge End Battery SOC. And battery will not discharge during the setting time.

4. LCD display and settings

4.1 LED Display

LED Indicator		Messages	
1	Green	Solid On	Working normal
		Flashing	fast: Warning slow: Firmware update
2	Red	Flashing	Fault condition occurs in the inverter

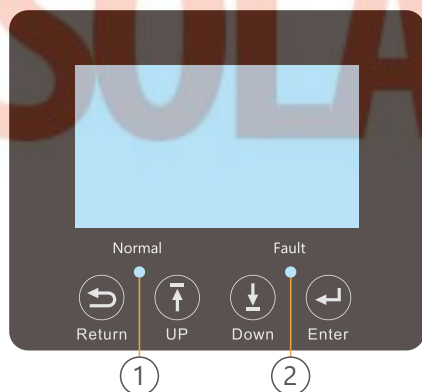

4.2 LCD Display

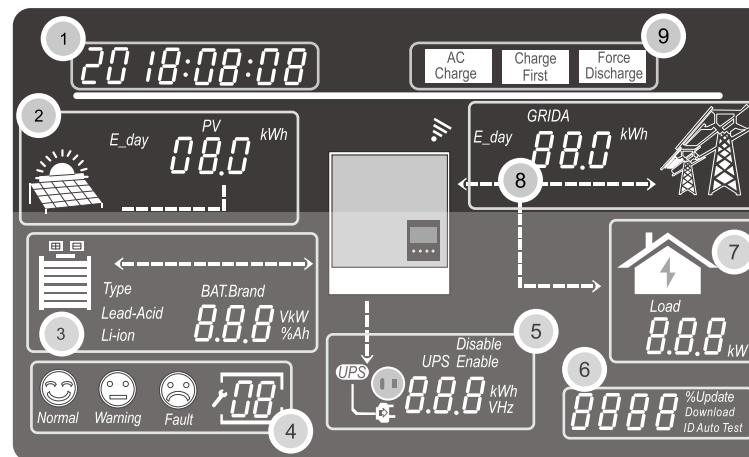

No.	Description	Remarks
1	Generally Information Display Area	Display the currently time/date by default(year/month/day/ hour/ minute" switching automatically). When press Up or Down buttons, this area will display the firmware version information, serial number etc. Display the setting selection information when entering settings
2	On-grid solar inverter output power and energy data	This area shows the data of PV voltage, power and the setting of PV input connection information
3	Battery information and data	This area shows the battery type, battery brand(lithium battery), the lead-Acid battery setting of CV voltage, Floating charging voltage, Cut off voltage, Discharge end voltage . And display the voltage, SOC and power in turns of period of 1 seconds
4	System working status / setting code	There are three type of working status- normal, warning and fault, in right side of this area, there are code display, it will display different type of code -the system working mode code, warning code, fault code and setting code
5	UPS/EPS output information and data	When UPS function is enabled, this area will display UPS voltage, frequency, power etc. in turns of periods of 1s
6	Programming & the percentage of AC output power	When firmware updating in process, it will display relevant information When in grid off, this area will display the Percentage of the maximum AC output power
7	Loads consumption	Display the power consumption by the loads in on grid model
8	Grid information and Generator information	Display the grid(GRIDA) information of voltage, frequency, input or output power, the Generator (GRIDB) information of voltage, frequency, input power ,switch period of 1s
9	Working mode settings area	When make settings on the SNA series inverter through the LCD, this area will display the AC Charge, Force Discharge, Charge First option for setting on those working modes. It will not display those information unless in the setting process.

4.3 Inverter Status Display

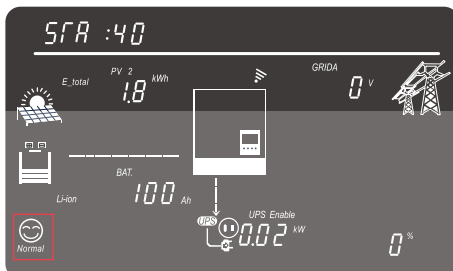
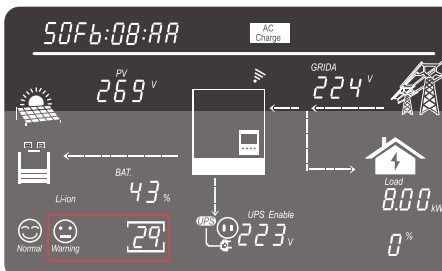
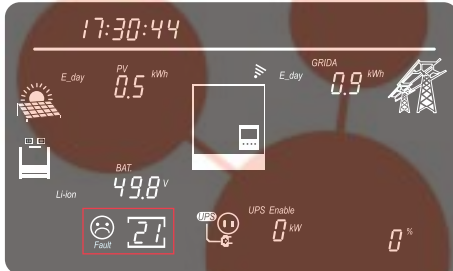
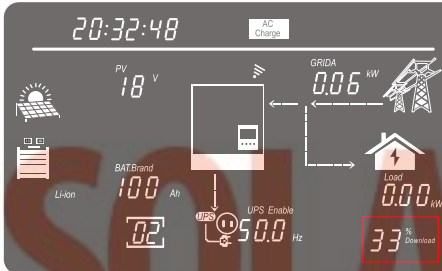
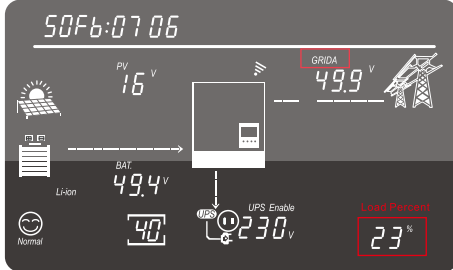
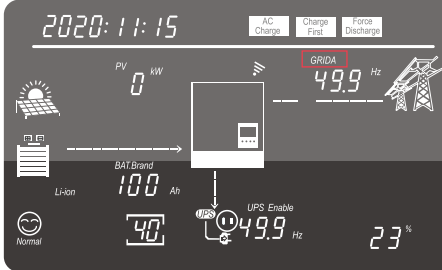
<p>Normal status, running status 40</p> 	<p>Warning Status, warning 29</p> 
<p>Fault status, fault 21</p> 	<p>Flash status:download percent is 33%</p> 
<p>When display 'GRIDA', it means the Grid information is about AC utility, The percent display on the right down corner means the load percentage</p> 	<p>When display 'GRIDB', it means the AC information is about Genset input</p> 

4.4 LCD Settings







Return



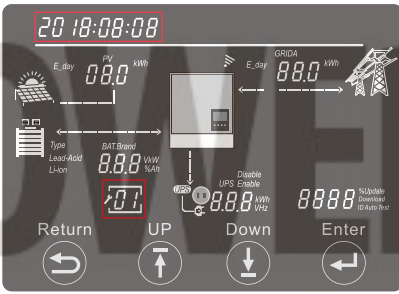

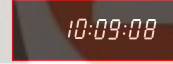
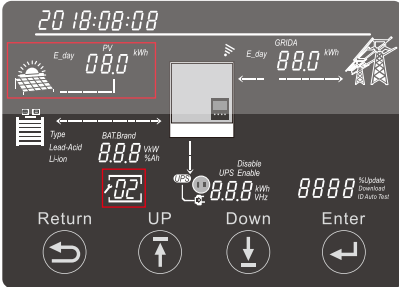

UP

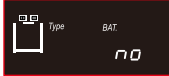
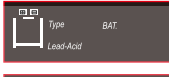

Down

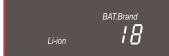

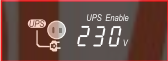

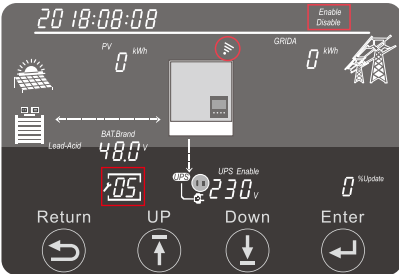

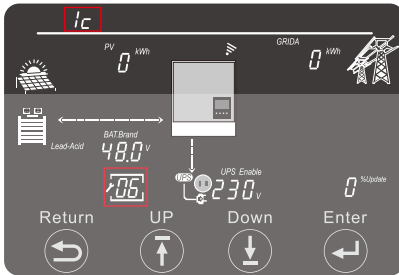
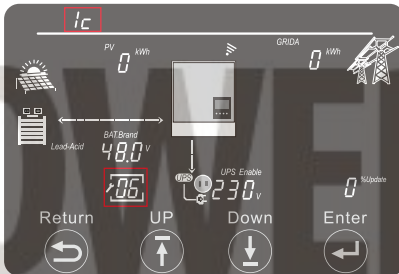
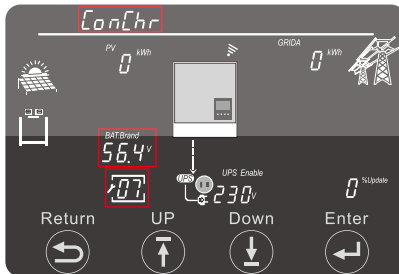

Enter

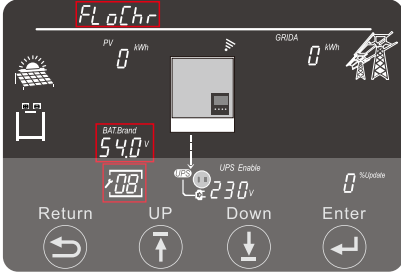

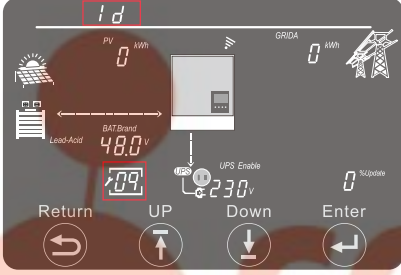

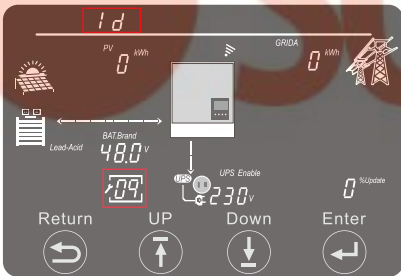

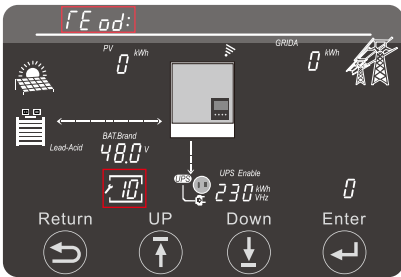
There are four buttons on the LCD.
 Step for setting by the display:
 Step1: After touch Enter button for about 2 seconds, the unit will enter setting mode. The setting icon and index will flashing.
 Step2: Touch UP or Down button to select setting index form 1 to 19.
 Step3: Then touch Enter button to set this item.
 Step4: Touch UP or Down button to change the settings.
 Step5: Touch Enter to confirm the setting or Return the setting list is as below.

Index	Description	Setting Option
1	Date & time	 <p>Setting Year/Month/day </p> <p>Setting hour/minute/second </p>
2	PV input mode	 <p>Default: S S: two independent Strings input </p> <p>P: Same string input for 2 MPPTs </p> <p>dc: DC source input </p>

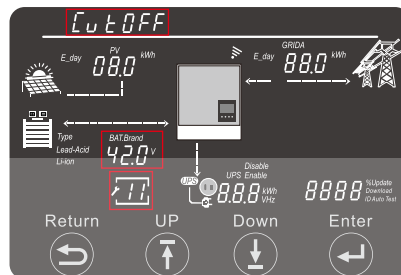
3	Battery	<p>Run with No Battery: Step1:Choose battery type first, when no flashing, select Enter to choose Run with No battery</p> 
		<p>For Lead Acid: Step1:Choose battery type first, when Lead-Acid flashing, select Enter to choose Lead-acid battery Step2:Then choose battery capacity</p>  
		<p>For Lithium battery Step1:Choose battery type first, when Li-ion flashing, select Enter to choose Li-ion battery Step2:Choose battery brand 0-> Standard Battery 2-> Pylon Battery 6-> Luxpower protocol Battery 8-> Dyness Battery</p>  
4	UPS Output voltage and frequency	 <p>AC Output voltage 200Vac/208Vac/220Vac/ 230Vac(Default)/240Vac</p>  <p>AC Output frequency 50Hz (Default)/60Hz</p> 
5	Buzzer enable	 <p>Buzzer enable(Default)</p> <p>Enable</p> <p>Buzzer Disable</p> <p>Disable</p>

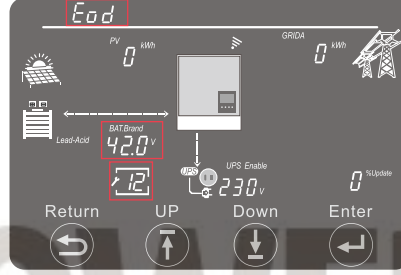
6	Ic:Maximum charge current	<p>MODEL: SNA5000WPV</p>  <p>Total charge current (Iac+Ipv)setting Setting range :0A~110A Default: 110A</p> <p>AC charge current setting: Setting range :0A~110A Default: 30A</p> <p>Generator charge current setting: Setting range :0A~60A Default: 30A</p>
		<p>MODEL: SNA6000WPV</p>  <p>Total charge current (Iac+Ipv)setting Setting range :0A~125A Default: 125A</p> <p>AC charge current setting: Setting range :0A~125A Default: 30A</p> <p>Generator charge current setting: Setting range :0A~110A Default: 30A</p>
7	ConChr: CV voltage setting (Only in Lead-acid battery type)	 <p>Setting range: 50.0-59.0Vdc Default: 56.4V</p> 

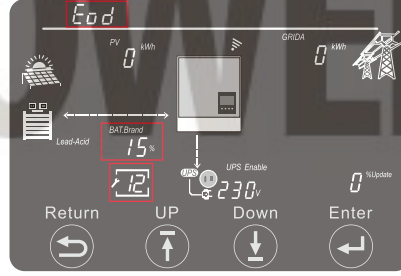
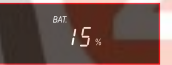
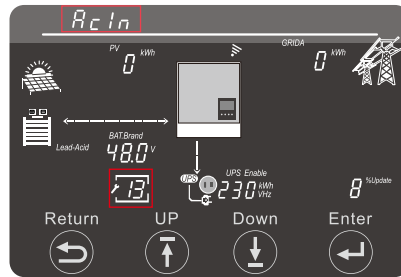
8	FloChr: Floating charging voltage setting (Only in Lead-acid battery type)		<p>Setting range: 50.0-56.0Vdc Default: 54.0V</p> 
9	Id: Maximum discharge current	<p>MODEL: SNA5000WPV</p> 	<p>Totoal discharge current setting Setting range :0A~110A Default: 110A</p> 
		<p>MODEL: SNA6000WPV</p> 	<p>Totoal discharge current setting Setting range :0A~140A Default: 140A</p> 
10	TEOd: Discharge control type: VOLT/SOC		<p>Setting Range: VOLT/SOC</p>  

11	CutOFF: Cut off Voltage or SOC, depend on TEOd		<p>Setting range: VOLT: 40.0-OnGrid EOD Volt Default: 42V</p>  <p>SOC: 0-OnGrid EOD SOC Default: 15%</p> 
12	Eod: Discharge end voltage or soc with grid, depend on TEOd		<p>Setting range: VOLT: Cut off Volt-58V Default: 42V</p> 
			<p>SOC: Cut off SOC -90 Default: 15%</p> 
13	AcIn: AC voltage range setting		<p>Unity AC Input voltage range : 90Vac~280Vac</p>  <p>Unity AC Input voltage range : 170Vac~280Vac</p> 

14 AC charge setting
(The setting process must enable the AC charging function, confirm the full battery SOC value, and set the confirmation time period 1, 2, 3 to truly complete the AC charging function setting)

AC Charge function:
Setting range:
1.DIS: AC charge disable;
2.TIM: According to time;
3.VOL: According to battery voltage;
4.SOC: According to battery soc;
(Touch "Enter" button to set ac charge parameter)

AcCh: d 14

14 AC charge control:
Setting range:
Vol:
1.Start Voltage: 35.4~52V;
2.End Voltage: 48~59V;
SOC:
1.Start Soc: 1~90%;
2.End Soc: 20~100%;

Setting AC Charge time of 1 start:
Range:00:00~23:59
Default:00:00~00:00

Setting AC Charge time of 1 end:
Range:00:00~23:59
Default:00:00~00:00

Similar to set time2 and times

AcCh: VOL
BAT: 42.0 V
BAT: 15 %
P1:00:00 start
P1:23:59 end

15 Utility source
(AC Input) to take Load time setting

Setting time of 1 start:
Range:00:00~23:59
Default:00:00~00:00

Setting time of 1 end:
Range:00:00~23:59
Default:00:00~00:00

Similar to set time 2 and time3

P1:00:00 start
P1:23:59 end
P2:00:00 start
P3:00:00 start

16 Hybrid enable/
disable

Setting Range:
Hybrid Disable (default)

Disable

Hybrid Enable

Enable

16 Feed-In
Enable/disable
Only valid when Hybrid is enabled

Setting Range:
Feed-In Disable (default)

Disable

Feed-In Enable

Enable

16 Maximum Feed-In percent
Only valid when Feed-In is enabled
Power percent can be set larger than 100% in case of there is other generating device in the system

Setting Range:0-100%
0% (default)

FEEd: 100

17 Battery Wakeup
Enable/disable
(Not for No Battery type)

Enable wakeup battery

BAT: YES

18 Max Generator
Input Power

Setting Range:0-7369W
7369W (default)

GEN: 7369 Power

19 PV Off Grid enable/disable

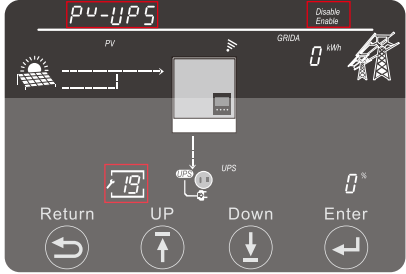

Setting Range:
PV Off Grid Enable (default)

Enable

PV Off Grid Disable

Disable

20 Power Save Function enable/disable

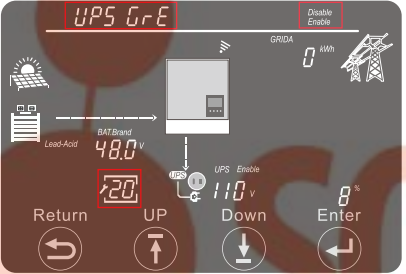

Setting Range:
Green Function Disable (default)

Disable

Green Function Enable:
When enabled, if the inverter load reading is less than 60W for more than 0minutes, the inverter output will be cut off.

Setting Range:
ECO Mode Disable (default) ECO Mode Enable

Disable **Enable**

Enable

21 Parallel setting

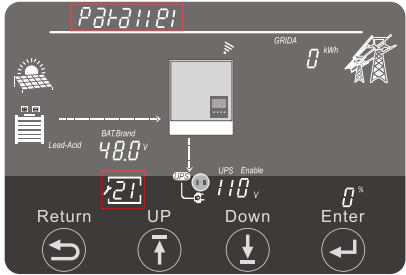

Parallel type setting
Setting Range: NoPL (not Parallel)/1PH (Single phase)/3PH (Three phase)

NoPL (default)

P2:P3:1PH

Bat Share enable/disable
Setting Range:
Disable (default)
Enable

Parallel phase setting
Setting Range: P1 (Rphase)/ P2(Sphase) /P3(Tphase)

P1 (default)

PHAS:P1

B2L5h3P2 **Disable Enable**

22 Error/Alarm Record

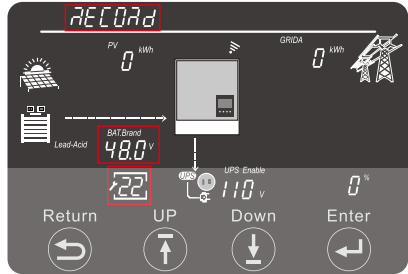

Error Record
-> Record Index
->> Record Msg:
(Year: Month:Day;
Hour: Min:Sec; Error code)

Err REC

Alarm Record-> Record Index->> Record Msg:
(Year:Month:Day; Hour:Min:Sec; Alarm code)

AL3 REC

23 CT Offset

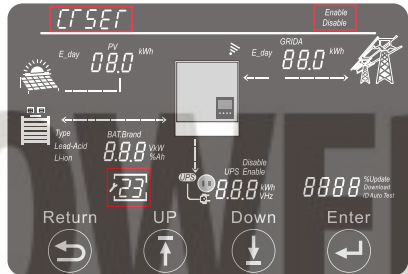

External Grid CT (Latest Version Only)
Setting Range:
Disable (default)/Enable

CF-EN **Disable Enable**

Internal CT Offset
Setting Range:-200~200W
20W (default)

CF -169 **Power**

24 Fan speed setting

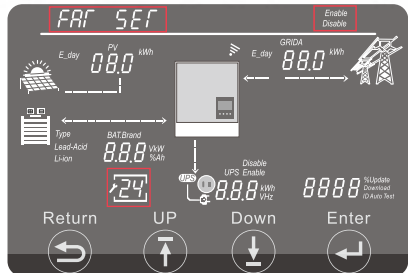

Fan1 Speed Percent
Setting Range: 20-100%
70% (default)

FAN : 055

Fan1 Speed New Slope
Setting Range:
Disable (default)
Enable

FAN SL OP **Disable Enable**

Fan2 Speed Percent
Setting Range: 20-100%
70% (default)

FAN : 055

Fan1 Speed New Slope Setting Range:
Disable (default)
Enable

FAN SL OP **Disable Enable**

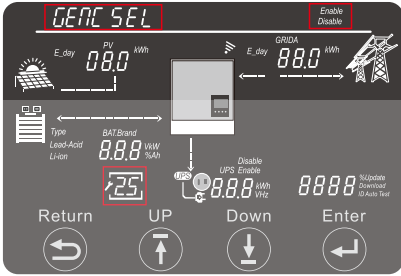
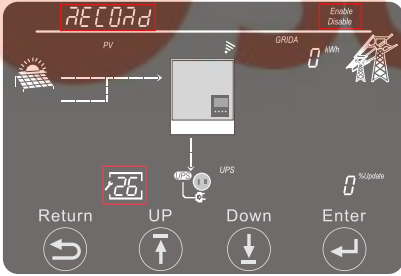
25	Generator charge setting	 <p>Generator charge setting -> charge control type Setting Range: 1.VOL (default) 2.SOC</p> <p>GENC VOL</p> <p>GENC SOC</p> <p>-> control type ->> control value Setting Range: VOL : 1.Start Voltage:38.4-52V; 2.End Voltage:48-59V; SOC: 1.Start Soc:1-90%; 2.End Soc:20-100%;</p> <p>GENC VOL Start</p> <p>BAT 42.0 V</p> <p>BAT 15 %</p>
26	Neutral-Ground Bonding Function	 <p>This setting allows the user to enable or disable the internal neutral-ground bond. The inverter must be in standby to make this change. Turn the "EPS Output" switch to off to engage standby mode.</p> <p>Range: Enable/Disable Default: Enable</p> <p>Enable</p> <p>Disable</p>

5. Monitor System for ECO Hybrid inverter

- Users can use wifi dongle / WLAN dongle / 4G dongle (Available from 2021 March for some countries) to monitor the energy storage system, The monitor website is: server.luxpowertek.com
- The APP is also available in the google play and apple APP store(Scan two code bar to download the APP).
- Please download the introduction of guidance by website: <https://www.luxpowertek.com/download/>
Document Reference:

1. Wifi Quick Guidance

Quick guidance for setting password for wifi module, the paper is also available in the wifi box

2. Monitor system setup for Distributors and **Monitor system setup for endusers**, Monitor system registration, wifi password setting, and wifi local monitor and setting

3. Lux_Monitor_UI_Introduction

Introduction of monitor interface

4. WebsiteSettingGuidance

Introduction of website settings for offgrid inverter

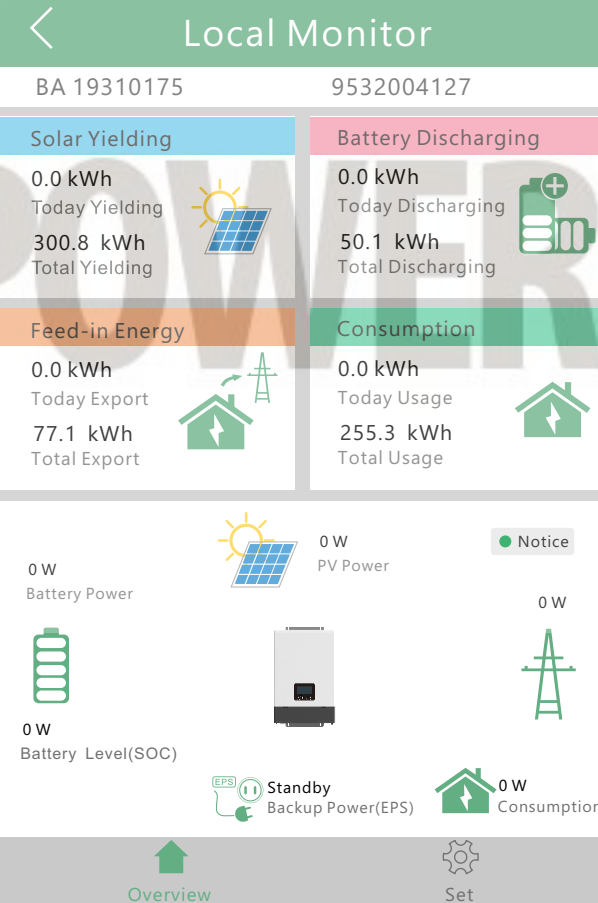

Local Monitor

BA 19310175 9532004127

Solar Yielding 0.0 kWh Today Yielding 300.8 kWh Total Yielding	Battery Discharging 0.0 kWh Today Discharging 50.1 kWh Total Discharging
Feed-in Energy 0.0 kWh Today Export 77.1 kWh Total Export	Consumption 0.0 kWh Today Usage 255.3 kWh Total Usage

0 W Battery Power 0 W PV Power Notice

0 W Battery Level(SOC)

Standby Backup Power(EPS) 0 W Consumption

Overview Set

6. Specifications

Table 1 MPPT Mode Specifications

INVERTER MODEL	SNA5000WPV	SNA6000WPV
Max. PV Array Power(W)	8000(4000/4000)	
Rated PV Input Voltage(V)	320	
Number of Independent MPPT Inputs	2	
PV Input Voltage Range(V)	100~480	
MPPT Voltage Range(V)	120~385	
Start-up Voltage(V)	100	
Max. PV Input Current per MPPT (A)	17/17	
Max. PV Short-circuit Current per MPPT(A)	25/25	
Max. PV Charging Current(A)	110	125

Table 2 Battery Mode Specifications

INVERTER MODEL	SNA5000WPV	SNA6000WPV
Output Voltage Waveform	Pure Sine Wave	
Output Voltage Regulation	208Vac/220Vac/230Vac/240Vac±5%	
Output Frequency	50Hz / 60Hz	
Rated Output Power(W)	5000	6000
Rated Output Current(A)	22	26.5
Max. Charging/ Discharging Current(A)	110/110	125/140
Max. Charging/ Discharging Power(W)	5000	6000
Peak Efficiency	93%	
Overload Protection	5s@ ≥ 150% load; 10s@ 110%~150% load	
Surge Capacity	2* rated power within 5 seconds	
Recommend Capacity of Battery per Inverter	>200AH	
Battery Voltage Range	46.4V-60V(Li)	38.4V-60V(Lead_Acid)
High DC Cut-off Voltage	59VDC(Li)	60VDC(Lead_Acid)
High DC Recovery Voltage	57.4VDC(Li)	58VDC(Lead_Acid)

Low DC Warning Voltage(Lead Acid)	load < 20%	44.0Vdc(Settable)
	20% ≤ load < 50%	Warning Voltage @load < 20% -1.2V
	load ≥ 50%	Warning Voltage @load < 20% -3.6V
Low DC Warning Return Voltage(Lead Acid)		Low DC Warning Voltage@Different load+2V
Low DC Cut-off Voltage(Lead Acid)	load < 20%	42.0Vdc(Settable)
	20% ≤ load < 50%	Cut-off Voltage @load < 20% -1.2V
	load ≥ 50%	Cut-off Voltage @load < 20% -3.6V
Low DC Cut-off Return Voltage(Lead Acid)	Cut-off Voltage@ load < 20% ≥ 45V	Low DC Cut-off Voltage @load < 20% +3V
	Cut-off Voltage@ load < 20% < 45V	48V
Low DC Warning SOC		20% SOC (Settable)
Low DC Warning Return SOC		Low DC Warning SOC +10%
Low DC Cut-off SOC		15% SOC (Grid on) (settable)
		15% SOC (Grid off) (settable)
Low DC Cut-off Return SOC		Low DC Cut-off SOC +10%
Charge Cut-off Voltage		58.4Vdc
No Load Power Consumption		<60W
Lead_Acid Battery Charging Algorithm		3-Step
Bulk Charging Voltage		Flooded Battery 58.4Vdc
		AGM / Gel Battery 56.4Vdc
Floating Charging Voltage		54Vdc

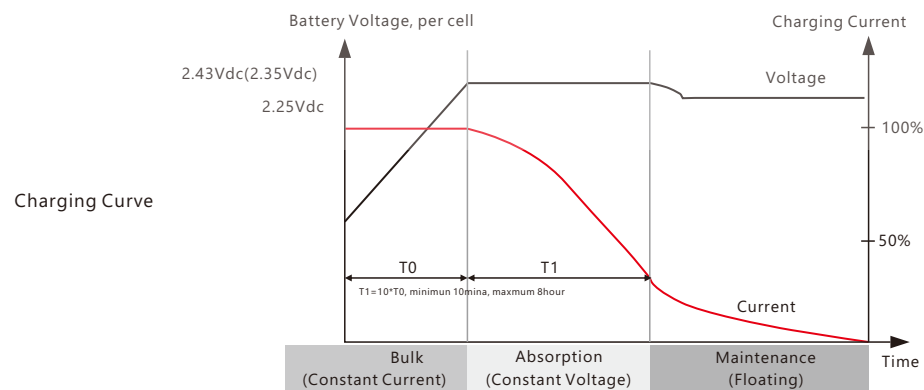

Table 3 Line Mode Specifications

INVERTER MODEL	SNA5000WPV	SNA6000WPV
Input Voltage Wavefor	Sinusoidal(utility or generator)	
Nominal Input Voltage(V)	230Vac	
Low Loss Voltage	170Vac±7V(UPS); 90Vac±7V(Appliances)	
Low Loss Return Voltage	180Vac±7V(UPS); 100Vac±7V(Appliances)	
High Loss Voltage	280Vac±7V	
High Loss Return Voltage	270Vac±7V	
Max. AC Input Voltage	280Vac	
Nominal Input Frequency	50Hz/60Hz(Auto detection)	
Max. AC Input Current(A)	35	39.5
Max. AC Input Power(W)	8000	9000
Max. AC Charging Current(A)	110	125
Rated AC Output Current(A)	22	26.5
Rated AC Output Power(W)	5000	6000
Rated AC Current of Bypass Relays(A)	40	60
Output Short Circuit Protection	Software Protect when GridOff Discharge Circuit Breaker Protect when GridOn Bypass	
Transfer Time	<15ms @ Single ; <30ms @ Parallel	
Output power derating: When AC input voltage drops to 200V, the output power will be derated.	Max inv current: 25A Max inv power: 5kW	Max inv current: 30A Max inv power: 6kW

Table 4 Generator Mode Specifications

INVERTER MODEL	SNA5000WPV	SNA6000WPV
Rated GEN Voltage(V)	230	
Rated GEN Frequency(Hz)	50/60	
Rated GEN Input Current(A)	32	
Rated GEN Input Power(W)	7370	
Rated GEN Current of Bypass Relays(A)	40	60

Table 5 Protection/General Specifications

INVERTER MODEL	SNA5000WPV	SNA6000WPV
Over Current/ Voltage Protection	YES	
Grid Monitoring	YES	
AC Surge Protection Type III	YES	
Safety Certification	NRS 097, CE	
Ingress Protection Rating	IP 20	
Display & Communication Interface	LCD+LED, RS485/WIFI/CAN	
Warranty	2 Years	
Cooling Method	FAN	
Topology	Transformer-less	
Noise Emission(typical)	<50dB	
Operating Temperature Range	0°C to 45°C (full load)	
Storage temperature	-15°C ~ 60°C	
Humidity	5% to 95% Relative Humidity(Non-condensing)	
Altitude	<2000m	
Dimension(D*W*H)mm	505*330*135mm	
Net Weight	14.5kg	

***115A@48VDC(AC), 125A@44VDC(AC), 125A@48VDC(PV)

7. Trouble Shooting & Error List

The failures mainly divided into 5 categories, for each category, the behavior is different:

Code	Description	Trouble shooting
E000	Internal communication fault1	Restart inverter, if the error still exist, contact us (DSP&M3)
E002	Bat On Mos Fail	Restart inverter, if the error still exist, contact us
E003	CT Fail	
E008	CAN communication error in Parallel System	Check CAN cable connection is connected to the right COM port
E009	No master in parallel system	Check parallel setting for master/Slave part, there should be one master in the system
E012	UPS output short circuit	Check if the load is short circuit, try to turn off the load and restart inverter
E013	UPS reserve current	Restart inverter, if the error still exist, contact us
E015	Phase Error in three phase parallel system	Check if the AC connection is right for three phase system, there should one at least one inverter in each phase
E016	Relay fault	Restart inverter, if the error still exist, contact us
E017	Internal communication fault2	Restart inverter, if the error still exist, contact us (DSP&M8)
E018	Internal communication fault3	Restart inverter, if the error still exist, contact us (DSP&M3)
E019	Bus voltage high	Check if PV input voltage is higher than 480V
E020	EPS connection fault	Check if EPS and AC connection is in wrong terminal
E021	PV voltage high	Check PV input connection and if PV input voltage is higher than 480V
E022	Over current internal	Restart inverter, if the error still exist, contact us
E024	PV short	Check PV connection
E025	Temperature over range	The internal temperature of inverter is too high, turn off the inverter for 10minutes, restart the inverter, if the error still exist, contact us
E026	Internal Fault	Restart inverter, if the error still exist, contact us (Bus sample)
E028	Sync signal lost in parallel system	Check CAN cable connection is connected to the right COM port
E029	Sync trigger signal lost in parallel system	
E031	Internal communication fault4	Restart inverter, if the error still exist, contact us (DSP&M8)

Code	Description	Trouble shooting
W000	Communication failure with battery	Check if you have choose the right battery brand and communication cable is right, if the warning still exist, contact us
W003	Communication failure with meter	Check communication cable, if the warning still exist, contact us
W004	Battery failure	Inverter get battery fault info from battery BMS, restart battery, if the warning still exist, contact us or battery manufacture
W008	Software mismatch	Please contact Luxpower for firmware update
W009	Fan Stuck	Check if the fan is OK
W012	Bat On Mos	Restart inverter, if the error still exist, contact us
W013	Over temperature	The temperature is a little bit high inside inverter
W015	Bat Reverse	Check the battery connection with inverter is right, if the warning still exist, contact us
W018	AC Frequency out of range	Check AC frequency is in range
W019	AC inconsistent in parallel system2	Reconnect the AC input or Restart inverter, if the error still exist, contact us
W025	Battery voltage high	Check if battery voltage is in normal range
W026	Battery voltage low	Check if battery voltage is in normal range, need to charge the battery if battery voltage is low
W027	Battery open	Check if there is output from the battery and battery connection with inverter is OK
W028	EPS Over load	Check if EPS load is too high
W029	EPS voltage high	Restart inverter, if the error still exist, contact us
W031	EPS DCV high	Restart inverter, if the error still exist, contact us