

SDM630MCT Series

Smart Three Phase Energy Meter



USER MANUAL
2024 V1.1

Statements

All rights reserved. Without the written permission of the company, no paragraphs or chapters in this manual can be extracted, copied or reproduced in any form. Otherwise, the violator shall bear all consequences.

Eastron reserves all legal rights.

Eastron reserves the right to amend the product specifications in this manual without prior notice. Before placing an order, please contact our company or local agent to get the latest specifications.

CONTENT

Version History	2
Risk Information	3
Chapter 1. Introduction	5
1.1 Product Introduction	5
1.2 Product Characteristics	5
1.3 Models Table	6
Chapter 2. Technical Parameters	6
2.1 Technical parameters	6
2.2 Accuracy	6
2.3 Communication	7
2.4 Performance criteria	7
2.5 Dimensions	8
2.6 Wiring diagram	8
Chapter 3. Operation	11
3.1 Installation display	11
3.2 Button Functions:	11
3.3 Measurements	12
3.3.1 Voltage and current	12
3.3.2 Frequency, Power factor and Demand	13
3.3.3 Power	14
3.3.4 Energy	14
3.4 Setup Mode	15
3.4.1 Password Validation	16
3.4.2 Communication Address	17
3.4.3 M-bus	17
3.4.4 RS485 Modbus RTU	18
3.4.5 CT	21
3.4.6 PT	22
3.4.7 Pulse	22
3.4.8 Demand Interval Time	23
3.4.9 Backlit Power Time	23
3.4.10 System Type	23
3.4.11 CO2	25
3.4.12 Ethernet Modbus TCP	25
3.4.13 Date and Time	27
3.4.14 Tariff and Time Segments	28
3.4.15 CLR	28
3.4.16 Password Modification	28
3.4.17 Current Direction	29
Chapter 4. Declaration of Conformity (For MID meter only)	30

Version History

Version	Date	Changes
1.0	2024-7-10	Initial issue
1.1	2024-11-22	Add multi-tariff Interface

Risk Information

Information for Your Own Safety

This manual does not contain all of the safety measures operating the equipment (module, device) for different conditions and requirements. However, it does contain information which you must know for your own safety and to avoid damages. These information are highlighted by a warning triangle indicating the degree of potential danger.



Warning

This means that failure to observe the instruction can result in death, serious injury or considerable material damage.



Caution

This means hazard of electric shock and failure to take the necessary safety precautions will result in death, serious injury or considerable material damage.

Qualified personnel

Operation of the equipment (module, device) described in this manual may only be performed by qualified personnel. Qualified personnel in this manual means person who are authorized to commission, start up, ground and label devices, systems and circuits according to safety and Regulatory standards.

Proper handling

The prerequisites for perfect, reliable operation of the product are proper transport, proper storage, installation and proper operation and maintenance. When operating electrical equipment, parts of this equipment automatically carry dangerous voltages. Improper handling can therefore result in serious injuries or material damage.

- ✧ Use only insulating tools.
- ✧ Do not connect while circuit is live (hot).
- ✧ Place the meter only in dry surroundings.
- ✧ Do not mount the meter in an explosive area or expose the meter to dust, mildew and insects.
- ✧ Make sure the wires are suitable for the maximum current of this meter.
- ✧ Make sure the AC wires are connected correctly before activating the current/voltage to the meter.
- ✧ Do not touch the meter connecting clamps directly with metal, blank wire and your bare hands as you may get electrical shock.
- ✧ Make sure the protection cover is placed after installation.
- ✧ Installation, maintenance and reparation should only be done by qualified personnel.
- ✧ Never break the seals and open the front cover as this might influence the function of the meter, and will cause no warranty.

- ✧ Do not drop, or allow strong physical impact on the meter as the high precisely components inside may be damaged.
- ✧ Designed to be mounted inside of switchboards or cabinet on DIN RAIL
- ✧ This device must have a suitable sized Circuit Breaker feeding the Multi Function Energy Meter so it does not exceed the maximum rated current.
- ✧ The supply wiring of this device shall be suitable sized cable to match the installed circuit breaker.
- ✧ A Disconnection Device (Circuit Breaker) should be installed close to the Multi Function Energy Meter.
- ✧ The Disconnection Device shall be marked as the Disconnection Device for the Multi Function Energy Meter

Disclaimer

We have checked the contents of this publication and every effort has been made to ensure that the descriptions are as accurate as possible.

However, deviations from the description cannot be completely ruled out, so that no liability can be accepted for any errors contained in the information given. The data in this manual is checked regularly and the necessary corrections are included in subsequent editions. We are grateful for any improvements that you suggest.

Chapter 1. Introduction

1.1 Product Introduction

The SDM630MCT series measures and displays the characteristics of single phase two wire (1p2w), single phase three wire (1p3w), three phase three wire (3p3w,) and three phase four wire (3p4w) supplies, including voltage, frequency, current, power ,active and reactive energy, imported or exported. Energy is measured in terms of kWh, kVAh. Maximum demand current can be measured over preset periods of up to 60 minutes. In order to measure energy, the unit requires voltage and current inputs in addition to the supply required to power the product. The requisite current input(s) are obtained via current transformers(CT).

SDM630MCT series can be configured to work with a wide range of CTs with 1A/5A output, giving the unit a wide range of operation. Three types of communication port are available on the meter for remote data transmission: RS485 Modbus , M-Bus and Ethernet Modbus TCP.

This unit can be powered from a separate auxiliary AC powersupply. Alternatively it can be powered from the monitored supply, where appropriate.

1.2 Product Characteristics

- Bi-directional measurement IMP & EXP
- Ethernet Modbus TCP (Only for SDM630MCT-TCP)
- Modbus RS485 RTU (For SDM630MCT,SDM630MCT-2T,SDM630MCT-MT,SDM630MCT-DI)
- M-Bus EN13757-3 (For SDM630MCT-MB & SDM630MCT-2T-MB)
- Multi-parameters measurement
- LCD with white backlit, adjustable backlit time

Measurements:

- Phase voltage: V1, V2, V3
- Line voltage: V1-2, V2-3, V3-1
- Current: I1, I2, I3,IN
- Active power: P1, P2, P3, P_total (total active power)
- Reactive power: Q1, Q2, Q3, Q_total (total reactive power)
- Apparent power: S1, S2, S3, S_Total (total apparent power)
- Frequency: Hz
- Power factor: PF
- Active energy: Ep_imp (import active energy), Ep_exp (export active energy), Ep_total (total active energy)
- Reactive energy: Eq_imp (import reactive energy), Eq_exp (export reactive energy), Eq_total (total reactive energy)
- THD-I and THD-U
- Maximum demand: MD

Setup:

- Ethernet Modbus TCP
- Modbus RS485 RTU & M-bus EN13757-3
- Demand Interval Time
- Backlit time
- Supply system 1p2w, 3p3w,3p4w
- Reset
- Password modification

1.3 Models Table

Model	RS485 Modbus	Mbus EN13757-3	Tariffs (RTC)	Dual Sources	Ethernet TCP	Digital Input
SDM630MCT-2T	●			●		
SDM630MCT	●					
SDM630MCT-MT	●		●			
SDM630MCT-2T-MB		●		●		
SDM630MCT-MB		●				
SDM630MCT-E*	●					
SDM630MCT-DI	●					●
SDM630MCT-TCP					●	

*Note: THD is not available on SDM630MCT-E

Chapter 2. Technical Parameters

2.1 Technical parameters

Voltage AC (Un)	3*230/400VAC
Voltage range	100 - 276V a.c. (not for 3p3w supplies)
Voltage between phase	172 to 480V a.c (3p supplies only)
Current input	0.05-5(6)A
Over current withstand	20Imax for 0.5S
Frequency rating value	50/60Hz
Frequency range	45 - 65Hz
AC voltage withstand	4KV/1min
Impulse voltage withstand	6kV – 1.2μS waveform
Power consumption	≤ 2W/10VA
Display	LCD with white backlit
Max. reading	9999999.9 kWh/kVAh

2.2 Accuracy

Voltage	0.5% of range maximum
Current	0.5% of normal
Frequency	0.2% of mid frequency
Power factor	1% of unity(0.01)
Active Power	±1% of range maximum
Reactive power	±1% of range maximum
Apparent power	±1% of range maximum
Active energy	Class1 IEC 62053-21/ Class 0.5S IEC62053-22/ Class B or C EN50470-3: 2022

Reactive energy	Class2 IEC 62053-23
-----------------	---------------------

2.3 Communication

RS485 Modbus RTU

For Modbus RTU, the following RS485 communication parameters can be configured from the Set-up menu:

Baud Rate	2400,4800,9600,19200,38400bps
Parity	NONE(default)/ ODD / EVEN
Stop bits	1 or 2
RS485 network address	nnn 3-digit number, 001 to 247Port: 502

Ethernet Modbus TCP (Only for SDM630MCT-TCP)

For Ethernet Modbus TCP, the following communication parameters can be configured from the Set-up menu:

Type	Ethernet
Protocol	Modbus-TCP
Modbus address range	1-247
IP	192.168.1.200 (default)
Port	502
MASK	255.255.255.0
Gateway	192.168.1.1
DHCP	Off (default)

M-bus Communication (For SDM630MCT-2T-MB & SDM630MCT-MB)

The meter provides an M-Bus port for remote communication. The protocol fully comply with EN13757-3.

The following communication parameters can be configured via M-bus communication:

Baud Rate	300,600,1200, 2400, 4800, 9600bps
Parity	NONE(default)/ ODD / EVEN
Stop bits	1 or 2
M-Bus network primary address	nnn - 3 digits number from 001 to 250
M-Bus network secondary address	00 00 00 00 to 99 99 99 99

2.4 Performance criteria

Operation humidity	≤90%
Storage humidity	≤95%
Operating temperature	-40°C~+70°C
Storage temperature	-40°C~+80°C
International standard	IEC62053-21
Installation category	CATIII
Protection against penetration of dust and water	front panel IP51 (indoor)
Insulating encased meter of protective class	II
Altitude	≤2000m

2.5 Dimensions

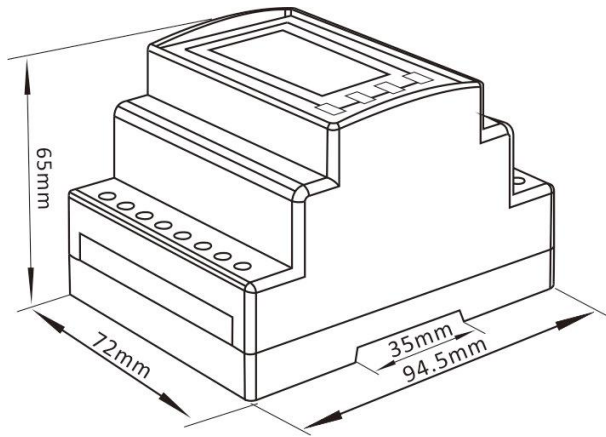

Height: 94.5 mm
 Width: 72mm
 Depth: 65mm

2.6 Wiring diagram

Current and Voltage Inputs

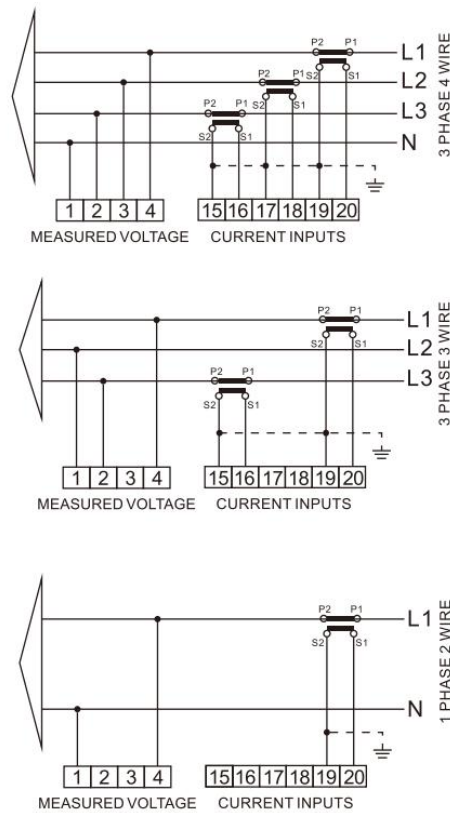

Definitions of Other Terminals

SDM630MCT-2T

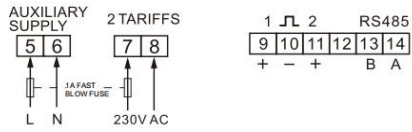

SDM630MCT/SDM630MCT-MT/SDM630MCT-E

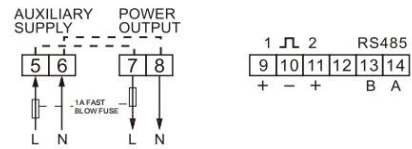

SDM630MCT-2T-MB

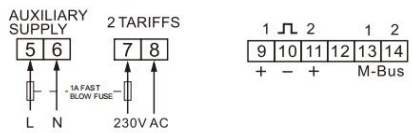

SDM630MCT-MB

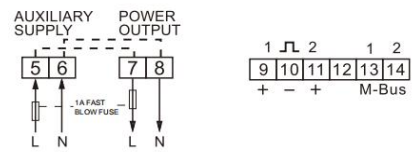

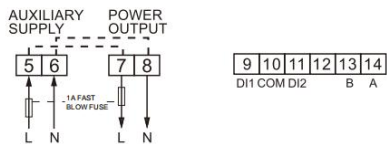

SDM630MCT-DI

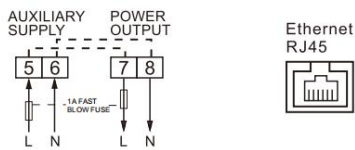

SDM630MCT-TCP



Wiring Guide

Terminal ① ② ③ ④ ⑤ ⑥ ⑦ ⑧	Measurement Connection	Screw Connection	Diameter 3.0mm*PH1 
	Strip Length	6-7mm	
	Screw	M3	
	Rigid/supple	0.5-2.5mm ² (30 ~ 14AWG)	
	Tightening torque	0.2Nm	
	Model	PZ0	
Terminal ⑨~⑳	Measurement Connection	Screw Connection	Diameter 3mm*PH1 
	Strip Length	6-7mm	
	Screw	M3	
	Fixed/flexible(Wire Range)	0.5-2.5mm ² (30 ~ 14AWG)	
	Tightening torque	0.2Nm	
	Model	PZ0	

Installation

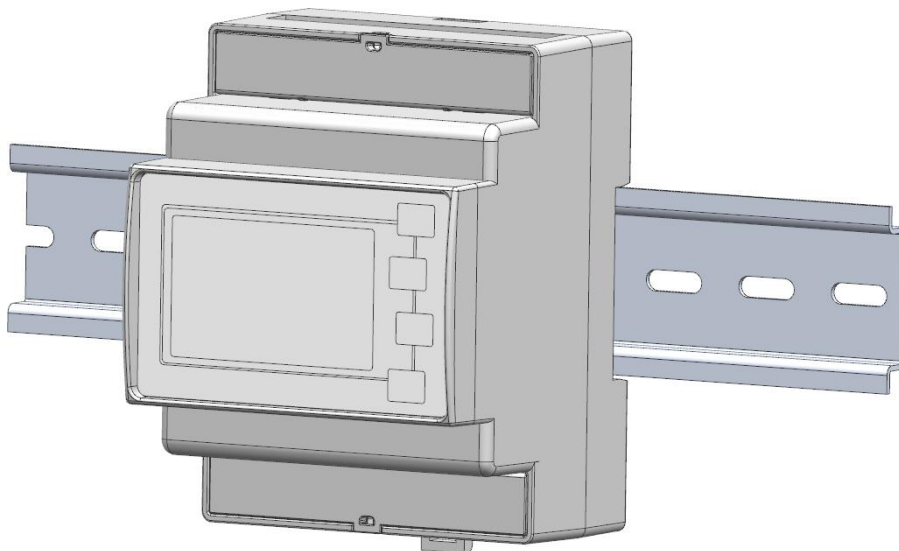

Chapter 3. Operation

3.1 Installation display

	<p>The first screen lights up all display segments and can be used as a display check.</p>
	<p>The second screen and the third screen indicates the firmware installed in the unit.</p>
	<p>Note: the actual display might be different with the left on here.</p>
	<p>The interface performs a self-test and indicates the result if the test passes.</p>

3.2 Button Functions:

Button	Short click		Long press (3s)	
	Display mode	Setup mode	Display mode	Setup mode
	V1 V2 V3 V1-2 V2-3 V3-1 I1 I2 I3 IN V %THD I %THD	Return to previous menu		
	Hz PF PF1 PF2 PF3 MD of I1 I2 I3 MD of Power	Previous page or increase value	Address Baud Rate Parity & Stop Bit CT1 & CT2 PT1 & PT2 Firmware	



			CRC All display segments	
	P1 P2 P3 Q1 Q2 Q3 S1 S2 S3 P-t Q-t S-t	Next page or decrease value		
	Active E-t Reactive E-t Imp Active E Exp Active E Imp Reactive E Exp Reactive E	Move to right side	Enter Setup mode	Confirm setting
<p>Note: For tariff meters, the display is different. Please refer to the following content for detailed information.</p>				

3.3 Measurements

3.3.1 Voltage and current

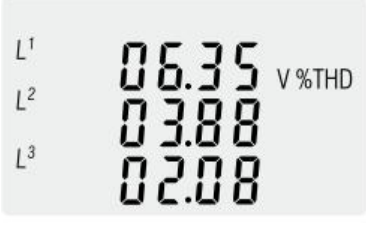

Each successive pressing of the button selects a new range:

	Phase to neutral voltage
	Phase to phase voltage
	Current on each phase
	Neutral current

	Phase to neutral voltage THD%
	Phase to neutral current THD%

3.3.2 Frequency, Power factor and Demand

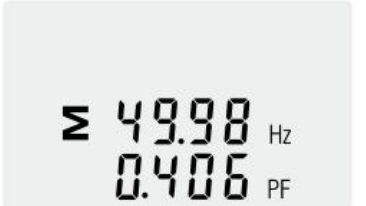
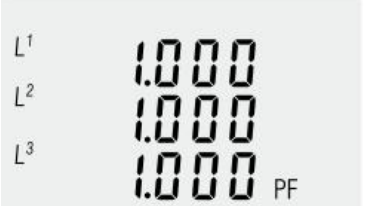
Each successive pressing of the  button selects a new range:

	Frequency and Power Factor (total)
	Power Factor of each phase
	Maximum current demand on each phase
	Maximum total power demand

3.3.3 Power



Each successive pressing of the  button select a new range:

	Instantaneous Active Power in kW
	Instantaneous Reactive Power in kVAr
	Instantaneous Volt-amps in kVA
	Total W, VAr, VA

3.3.4 Energy





Each successive pressing of the  button shows following measurements:

	Total active energy in kWh
--	----------------------------

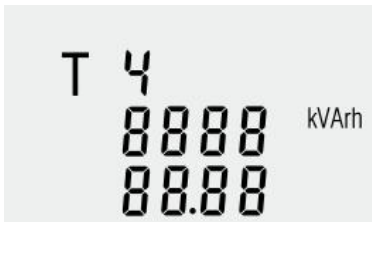
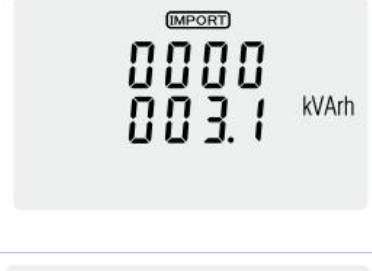





	<p>T1 active energy in kWh *Only for SDM630MCT-MT (Run means under T1 calculation)</p>
	<p>T2 active energy in kWh *Only for SDM630MCT-MT</p>
	<p>T3 active energy in kWh *Only for SDM630MCT-MT</p>
	<p>T4 active energy in kWh *Only for SDM630MCT-MT</p>
	<p>Total reactive energy in kVAh</p>
	<p>T1 reactive energy in kVAh *Only for SDM630MCT-MT (Run means under T1 calculation)</p>
	<p>T2 reactive energy in kVAh *Only for SDM630MCT-MT</p>

 <p>T 3 0000 00.00 kVArh</p>	<p>T3 reactive energy in kVArh *Only for SDM630MCT-MT</p>
 <p>T 4 0000 00.00 kVArh</p>	<p>T4 reactive energy in kVArh *Only for SDM630MCT-MT</p>
 <p>IMPORT 0000 006.8 kWh</p>	<p>Imported active energy in kWh *Not shown on 2 tariffs or 4 tariffs meter</p>
 <p>EXPORT 0000 003.3 kWh</p>	<p>Exported active energy in kWh *Not shown on 2 tariffs or 4 tariffs meter</p>
 <p>IMPORT 0000 003.1 kVArh</p>	<p>Imported reactive energy in kVArh *Not shown on 2 tariffs or 4 tariffs meter</p>
 <p>EXPORT 0000 00 1.3 kVArh</p>	<p>Exported reactive energy in kVArh *Not shown on 2 tariffs or 4 tariffs meter</p>
 <p>0000 00.00 k</p>	<p>Carbon emissions per kWh of electricity *For SDM630MCT-TCP only</p>

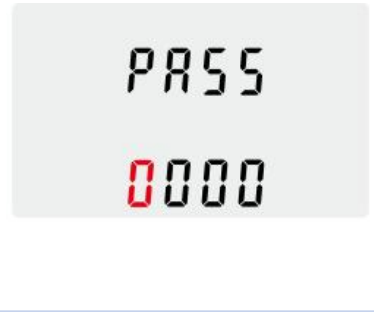

















	<p>Date *Only for SDM630MCT-MT</p>
	<p>Time *Only for SDM630MCT-MT</p>













3.4 Setup Mode















The meter's settable parameters are password protected. By long pressing the 4th button "E", the user can get into the setup mode.

<h4>3.4.1 Password Validation</h4>	
	<p>Press button  and  to enter password.</p> <p>Long press button  for password confirmation.</p> <p>If an incorrect password is entered, the display will show "Err". If the password is correct, the unit will show the setup menu.</p> <p>Password: default 1000</p>
<h4>3.4.2 Communication Address</h4>	
	<p>Communication address setup</p> <p>Long press  to enter the setup</p> <p>Address range 001~247 Address range 001~250 (Only for SDM630MCT-MB & SDM630MCT-2T-MB)</p>

	<p>Communication address setup</p> <p>Long press button to enter the setup mode.</p>
	<p>Press button and to set the addresses.</p> <p>Long press button to confirm.</p>
<p>3.4.3 M-bus Setup (Only for SDM630MCT-MB & SDM630MCT-2T-MB)</p>	
<p>3.4.3.1 M-bus Secondary Address Setting</p>	
	<p>Secondary address: 00000001 to 99999999</p> <p>From the Set-Up Menu, use and buttons to find the setting page.</p>
	<p>Long press to enter the selection routine. The current setting will flash.</p>
	<p>Use and buttons to set the secondary address.</p>
<p>3.4.3.2 Baud Rate Setting</p>	
	<p>From the Set-up menu, use and buttons to select the Baud Rate option.</p>



















	<p>Press  to enter the selection routine. The current setting will flash.</p>
	<p>Use  and  buttons to choose Baud rate 0.3k, 0.6k, 2.4k, 4.8k, 9.6k.</p>
<p>3.4.3.3 Parity</p>	
	<p>From the Set-up menu, use  and  buttons to select the Parity option.</p>
	<p>Press  to enter the selection routine. The current setting will flash.</p>
	<p>Use  and  buttons to choose Parity (EVEN / ODD / NONE)</p>
<p>3.4.3.4 Stop Bits</p>	
	<p>From the Set-up menu, use  and  buttons to select the Stop Bit option.</p>
	<p>Press  to enter the selection routine. The current setting will flash.</p>





	<p>Use  and  buttons to choose Stop Bit (2 or 1)</p>
<p>3.4.4 RS485 Modbus RTU Setup (For SDM630MCT/SDM630MCT-2T/SDM630MCT-MT/SDM630MCT-DI)</p>	
<p>3.4.4.1 Baud Rate Setting</p>	
	<p>From the Set-up menu, use  and  buttons to select the Baud Rate option.</p>
	<p>Press  to enter the selection routine. The current setting will flash.</p>
	<p>Use  and  buttons to choose Baud rate 2.4k, 4.8k, 9.6k, 19.2k, 38.4k</p>
<p>3.4.4.2 Parity</p>	
	<p>From the Set-up menu, use  and  buttons to select the Parity option.</p>
	<p>Press  to enter the selection routine. The current setting will flash.</p>



	<p>Use  and  buttons to choose Parity (EVEN / ODD / NONE)</p>
<p>3.4.4.3 Stop Bits</p>	
	<p>From the Set-up menu, use  and  buttons to select the Stop Bit option.</p>
	<p>Press  to enter the selection routine. The current setting will flash.</p>
	<p>Use  and  buttons to choose Stop Bit (2 or 1)</p>
<p>3.4.5 CT Setting</p>	
	<p>From the Set-up menu, use  and  buttons to select the CT option.</p>
	<p>Secondary CT setting Press  to enter the CT secondary current selection routine.:5A/1A</p>
	<p>Set CT 1 value Press  to enter the CT1 setting screen. The range is from 0001 to 9999.</p>











<h3>3.4.6 PT Setting</h3>	
	<p>From the Set-up menu, use and buttons to select the PT option. The screen will show the voltage PT secondary voltage value. The default value is 400V</p>
	<p>Secondary PT setting Press to enter the PT secondary voltage selection routine. The range is from 100 to 500V</p>
	<p>Set PT 1 value Press to enter the PT ratio screen. The range is from 0001 to 9999</p>
<h3>3.4.7 Pulse Setup (Not available on SDM630MCT-DI & SDM630MCT-TCP)</h3>	
<h4>3.4.7.1 Pulse Output Setup</h4>	
	<p>From the Set-Up Menu, use and buttons to select the Pulse output option.</p>
	<p>Press to enter the selection routine. The unit symbol will flash. Use and buttons to choose kWh or kVArh, import, export or total.</p>
<h4>3.4.7.2 Pulse Rate Setup</h4>	
	<p>Use this to set the energy represented by each pulse. Rate can be set to 1 pulse per 0.01/0.1/1/10/100/1000kWh/kVArh.</p>

















	<p>From the Set-Up Menu, use and buttons to select the pulse rate option.</p>
	<p>Press to enter the selection routine. The current setting will flash. 0.01/0.1/1/10/100/1000kWh/ kVArh per pulse.</p> <p>Use and buttons to choose pulse rate. Long press to confirm the setting and press to return to the main Set-Up Menu.</p>
<h3>3.4.7.3 Pulse Duration Setup</h3>	
	<p>The energy monitored can be active or reactive and the pulse width can be set as 200,100 or 60ms.</p>
	<p>From the Set-Up Menu, use and buttons to select the pulse width option.</p>
	<p>Press to enter the selection routine. The current setting will flash.</p> <p>Use and buttons to choose pulse rate. Long press to confirm the setting and press to return to the main Set-Up Menu.</p>
<h3>3.4.8 Demand Interval Time setup</h3>	





















	<p>Long press button  to enter the setup.</p>
	<p>Press button  and  to set the demand period value.</p> <p>Long press button  to confirm.</p> <p>Option: 0,5, 8, 10, 15, 20, 30, 60(default) Unit: min.</p>
<h3>3.4.9 Backlit Power Time Setup</h3>	
	<p>Long press button  to enter the setup.</p>
	<p>Press button  and  to set the value.</p> <p>Long press button  to confirm.</p> <p>Option: ON, OFF, 5, 10, 30, 60(default), 120 mins ON means backlit always on, OFF means backlit always off.</p>
<h3>3.4.10 System Type Setup</h3>	
	<p>Long press button  to enter the setup.</p>
	<p>Press button  and  to setup the supply system.</p> <p>Option: 3P4W, 3P3W, 1P2W</p> <p>Long press button  to confirm.</p> <p>Option: 3P4W(default), 3P3W, 1P2W</p>
<h3>3.4.11 CO2 setup</h3>	

	<p>Long press button  to enter the CO2 setup.</p>
	<p>Press button  and  to setup the CO2 rate. Default: (0.5703)</p>
<h3>3.4.12 Ethernet Modbus TCP setup (Only for SDM630MCT-TCP)</h3>	
<h4>3.4.12.1 DHCP function setup</h4>	
	<p>Long press button  to enter the setup mode of TCP IP information.</p>
	<p>Press button  and  to choose DHCP on or off. Default: off</p>
<h4>3.4.12.2 TCP IP address setup</h4>	
	<p>Long press button  to set IP address.</p>
	<p>IP-High 192.168 (default)</p>

	<p>IP-Low 001.200 (default)</p>
<p>3.4.12.3 Subnet Mask address setup</p>	
	<p>Long press button  to enter the setup mode.</p>
	<p>Subnet mask-High 255.255 (default)</p>
	<p>Subnet mask-Low 255.0 (default)</p>
<p>3.4.12.4 TCP gateway address setup</p>	
	<p>Long press button  to enter the setup mode of IP address of TCP gateway</p>
	<p>TCP gateway address - High: 192.168 (default)</p>

	TCP gateway address - Low: 001.001 (default)
3.4.12.5 TCP IP Port setup	
	Long press button  to enter the setup mode of TCP IP port
	TCP IP port: 502(default)
3.4.13 Date and Time setup (Only for SDM630MCT-MT)	
	From the Set-up menu, use  and  buttons to select the parity option.
	Press  to enter the selection routine. The current setting will flash, use  and  buttons to select the time option. Press  to confirm.
	From the set-up menu, use  and  buttons to select the time option.

	<p>Press  to enter the selection routine. The current setting will flash. Press  and  to select value, press  to confirm.</p>
<h3>3.4.14 Tariff and Time Segments (Only for SDM630MCT-MT)</h3>	
	<p>Display tariff and corresponding time segments.</p>
	<p>Use  and  buttons to select the display of tariff (01-08).</p>
<h3>3.4.15 CLR setup</h3>	
	<p>From the Set-up menu, use  and  buttons to select the reset option.</p>
	<p>Press  to enter the selection routine. The MD will flash.</p>
<h3>3.4.16 Password Modification Setup</h3>	
	<p>Long press button  to enter the setup mode.</p>

	<p>Press button  and  to enter the new password.</p> <p>Long press button  to confirm.</p> <p>Range: 0000~9999, default 1000.</p>
<h3>3.4.17 Current direction set-up</h3>	
	<p>use  and  buttons to select page "SET sys cont"</p>
	<p>Press to  enter Phase A , the default is Frd (forward)</p>
	<p>Press button  and  to change the current direction.</p> <p>Long press button  to confirm.</p>
	<p>Press to  enter Phase B , the default is Frd (forward)</p>
	<p>Press button  and  to change the current direction.</p> <p>Long press button  to confirm.</p>
	<p>Press to  enter Phase C , the default is Frd (forward)</p>

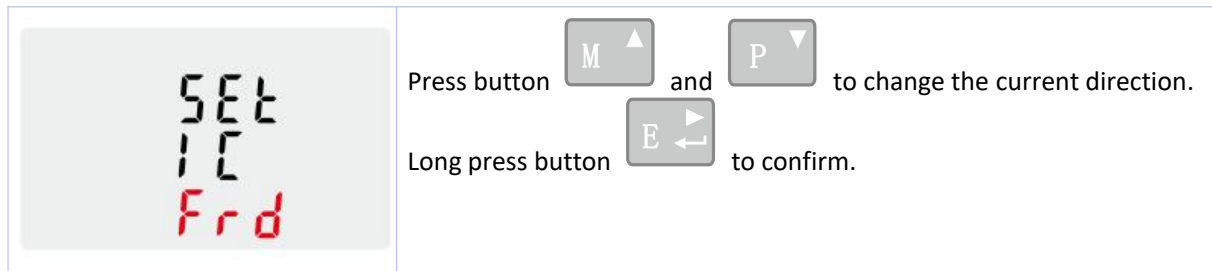

Chapter 4. . Declaration of Conformity (For MID meter only)

We Zhejiang Eastron Electronic Co., Ltd. Declares under our sole responsibility as the manufacturer that the Three phase multifunction electrical energy meter SDM630MCT series correspond to the production model described in the EU-type examination certificate and the requirements of the Directive 2014/32/EU. Type examination certificate number 0120/SGS0703. Identification number of the Notified Body: 0598.

If you have any question, please feel free to contact our sales team.

Eastron Electronic Co., Ltd.

No. 52, Dongjin Road, Nanhu, Jiaxing, Zhejiang, China

Tel: +86-573-83698881 Fax: +86-573-83698883

Email: sales@eastrongroup.com

www.eastrongroup.com

